

FUJITSU

INVERTER



AIR CONDITIONER

Compact Wall Mounted Type

OPERATING MANUAL

MODE D'EMPLOI

MANUAL DE FUNCIONAMIENTO

English

Français

Español

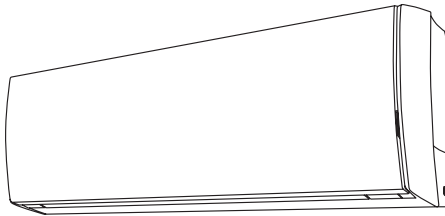

KEEP THIS OPERATING MANUAL FOR FUTURE REFERENCE

CONSERVER CE MANUEL D'UTILISATION POUR POUVOIR LE CONSULTER ULTÉRIEUREMENT

CONSERVE ESTE MANUAL DE FUNCIONAMIENTO PARA FUTURA REFERENCIA



FUJITSU GENERAL LIMITED

PART NO. 9319356075

SAFETY PRECAUTIONS.....	2	MIN. (Minimum) HEAT OPERATION.....	12
FEATURES AND FUNCTIONS	3	OUTDOOR UNIT LOW NOISE OPERATION	12
NAME OF PARTS	4	MANUAL AUTO OPERATION	12
PREPARATION	6	ON/OFF TIMER OPERATION	13
OPERATION.....	7	PROGRAM TIMER OPERATION	14
ADJUSTING THE DIRECTION OF AIR CIRCULATION	9	SLEEP TIMER OPERATION	15
SWING OPERATION	9	WEEKLY TIMER OPERATION.....	16
ENERGY SAVING PROGRAM	10	CLEANING AND CARE.....	20
POWERFUL OPERATION	11	TROUBLESHOOTING	22
ECONOMY OPERATION	11	OPERATING TIPS.....	23

SAFETY PRECAUTIONS

- Before using the appliance, read these “PRECAUTIONS” thoroughly and operate in the correct way.
- The instructions in this section all relate to safety; be sure to maintain safe operating conditions.
- “DANGER”, “WARNING” and “CAUTION” have the following meanings in these instructions:

 DANGER	This mark indicates procedures which, if improperly performed, are most likely to result in the death or serious injury to the user or service personnel.
 WARNING	This mark indicates procedures which, if improperly performed, might lead to the death or serious injury of the user or service personnel.
 CAUTION	This mark indicates procedures which, if improperly performed, might possibly result in personal harm to the user, or damage to property.

DANGER

- Do not attempt to install this air conditioner by yourself.
- This air conditioner contains no user-serviceable parts. Always consult authorized service personnel for repairs.
- When moving, consult authorized service personnel for disconnection and installation of the air conditioner.
- Do not become excessively chilled by staying for many hours in the direct cooling airflow.
- Do not insert fingers or objects into the outlet port or intake grille.
- Do not start and stop air conditioner operation by disconnecting the electrical breaker and so on.
- Take care not to damage the power supply cord.
- If the power supply cord of this appliance is damaged, it should only be replaced by the authorized service personal, since special purpose tools and specified cord are required.
- In the event of a malfunction (burning smell, etc.), immediately stop operation, turn off the breaker, and consult authorized service personnel.
- In the event of refrigerant leakage, be sure to keep away from fire or any flammables. (consult an authorized service personnel)

CAUTION

- Provide occasional ventilation during use.
- Do not direct airflow at fireplaces or heating apparatus.
- Do not climb on, or place objects on, the air conditioner.
- Do not hang objects from the indoor unit.
- Do not set flower vases or water containers on top of air conditioners.
- Do not place any other electrical products or household belongings under indoor unit or outdoor unit. Dripping condensation from the unit might get them wet, and may cause damage or malfunction of your property.
- Do not expose the air conditioner directly to water.
- Do not operate the air conditioner with wet hands.
- Do not pull power supply cord.
- Turn off power supply when not using the indoor unit for extended periods.
- Check the condition of the installation stand for damage.
- Do not place animals or plants in the direct path of the airflow.
- Do not drink the water drained from the air conditioner.
- Do not use in applications involving the storage of foods, plants or animals, precision equipment, or art works.
- Do not touch the aluminum fins of heat exchanger built-in the indoor or outdoor unit to avoid personal injury when you install or maintain the unit.
- Connection valves become hot during Heating; handle with care.
- Do not apply any heavy pressure to radiator fins.
- Operate only with air filters installed.
- Do not block or cover the intake grille and outlet port.
- Ensure that any electronic equipment is at least 1m away from either the indoor or outdoor units.
- Avoid installing the air conditioner near a fireplace or other heating apparatus.
- When installing the indoor and outdoor unit, take precautions to prevent access to infants.
- Do not use inflammable gases near the air conditioner.
- This appliance is not intended for use by persons (including children) with reduced physical, sensory or mental capabilities, or lack of experience and knowledge, unless they have been given supervision or instruction concerning use of the appliance by a person responsible for their safety. Children should be supervised to ensure that they do not play with the appliance.

FEATURES AND FUNCTIONS

■ Energy saving and Comfortable function

INVERTER

At the start of operation, large amount of power is used to bring the room quickly to the desired temperature. Afterward, the air conditioner automatically switches to a low power setting for economic and comfortable operation.

ENERGY SAVING PROGRAM

When the sensor detects that there is no one in the room, it automatically reduces the operating power. It saves you money by reducing the power consumed.

ECONOMY OPERATION

When ECONOMY operation mode is operated, the room temperature will be little higher than the set-temp under cooling mode and lower than set-temp under heating mode. Therefore, the ECONOMY mode is able to save more energy than other normal mode.

SWING OPERATION

The Airflow Direction Louvers swings automatically up and down so that the air speeds to every nook and corner of your room.

AUTO CHANGEOVER

The operation mode (cooling, dry, heating) is switched automatically to maintain the set temperature, and the temperature is kept constant at all times.

SUPER QUIET OPERATION

The indoor unit's airflow is reduced to produce quieter operation.

MIN. (Minimum) HEAT OPERATION

The room temperature can be maintained at 50 °F (10°C) so as to prevent the room temperature from falling too far.

OUTDOOR UNIT LOW NOISE OPERATION

OUTDOOR UNIT LOW NOISE operation mode reduces the noise level of the outdoor unit by suppressing the fan speed and the rotation number of the compressor. It is effective when the surrounding area is quiet, such as in the night.

*This function cannot be used for the Multi-type air conditioner.

■ Convenient function

WEEKLY TIMER

The combination of the temperature setting and the timer function, which you can choose any day between Monday and Sunday, can be set freely.

You can set up to four ON Timers or OFF Timers in one day.

PROGRAM TIMER

The program timer allows you to integrate OFF timer and ON timer operations in a single sequence. The sequence can involve 1 transition from OFF timer to ON timer, or from ON timer to OFF timer, within a 24 hour period.

SLEEP TIMER

When the SLEEP button is pressed during Heating mode, the indoor unit's temperature setting is gradually lowered during the period of operation; during cooling mode, the temperature setting is gradually raised during the period of operation. When the set time is reached, the indoor unit automatically turns off.

POWERFUL OPERATION

The product will operate at maximum power, which is convenient when you want to quickly cool down or warm up the room.

■ Clean function

MILDEW-RESISTANT FILTER

The Air Filter has been treated to resist mildew growth, thus allowing cleaner use and easier care.

POLYPHENOL CATECHIN AIR CLEANING FILTER

The Polyphenol Catechin Air Cleaning filter uses static electricity to clean fine particles and dust in the air such as tobacco smoke and plant pollen that are too small to see. The filter contains catechin, which is highly effective against various bacteria by suppressing the growth of the bacteria adsorbed to the filter.

Note that when the Air Cleaning Filter is installed, the amount of air produced decreases, causing a slight decrease in the indoor unit's performance.

NEGATIVE AIR IONS DEODORIZING FILTER

It comprises pottery super micro particles which can produce negative air ions having the effect of deodorizing and can absorb and remit the peculiar smell at home.

■ Remote controller

WIRELESS REMOTE CONTROLLER

The Wireless Remote Controller allows convenient control of indoor unit operation.

WIRED REMOTE CONTROLLER (OPTION)

The optional wired remote controller can be used. When you use remote controller, there are following different points as compared with using wireless remote controller.

And you can use both wired and wireless remote controller simultaneously. (But function is limited)

When the restricted functions on the remote controller are used, beeping sound will be heard, OPERATION, TIMER and the 3rd lamp of the indoor unit will flash.

[The restricted functions for wireless ones]

- ENERGY SAVING PROGRAM
- MIN. HEAT OPERATION
- OUTDOOR UNIT LOW NOISE OPERATION
- WEEKLY TIMER
- ON/OFF TIMER
- PROGRAM TIMER
- SLEEP TIMER
- POWERFUL OPERATION

NAME OF PARTS

INDOOR UNIT

Open Panel

It opens at the same time of operation, and shuts when operation stops.

- Please do not touch by hand or put your finger into it during the open panel opening/shutting operation. Or your finger might be injured.
- Please do not move the open panel by hand. It may cause breakdown, vapor may condense near the outlet louvers and drops of water may drip from it if you move it forcibly.
- Please do not hang objects on open panel, or put objects into the panel while it is open. It causes breakdown.

Human Sensor

Right-Left Louver (behind Airflow Direction Louver)

Intake Grille

- Before starting operation, make sure that the intake grille has been shut completely. (See page 20.) Incomplete closing of the intake grille might have an effect on the proper working or performance of the air conditioner.

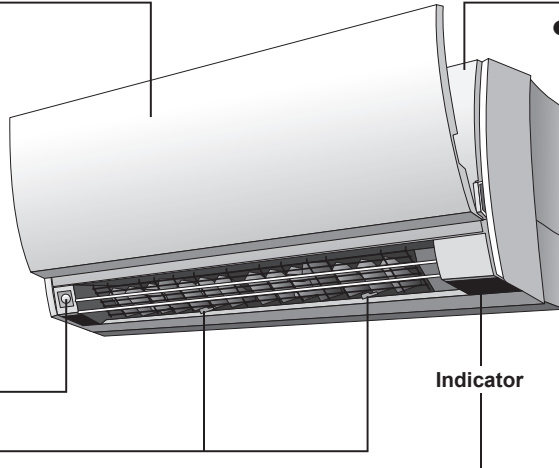

Remote Control Signal Receiver & MANUAL AUTO button

- When the battery in remote control is dead or the remote control is lost, press the MANUAL AUTO button can resume emergency operation.
- When the MANUAL AUTO button is pressed in for more than 10 seconds, the forced cooling operation will start.
- The forced cooling operation is used at the time of installation. Only for authorized service personnel's use.
- When the forced cooling operation starts by any chance, press the START/STOP button (M) to stop the operation.



OPERATION Indicator Lamp (green)

Lights during the normal operation, and flashes slowly during the Automatic Defrosting operation.

TIMER Indicator Lamp (orange)

If the TIMER indicator lamp flashes when the timer is operating, it indicates that a fault has occurred with the timer setting. (See page 23).

ECONOMY Indicator Lamp (green)

ECONOMY indicator lamp lights when ECONOMY OPERATION and MIN. HEAT OPERATION is operating.

Open the Intake Grille (See page 20)

Air Cleaning Filter

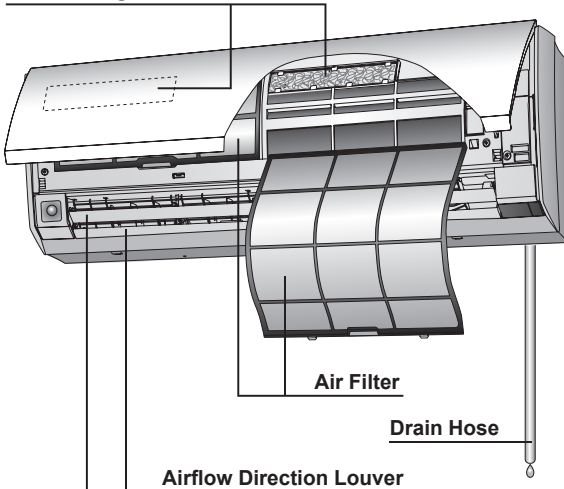

Accessories of the indoor unit

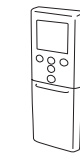

Remote controller



Remote controller holder



Tapping screws

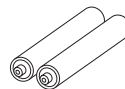

Batteries

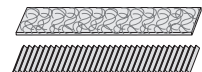

Air cleaning filters

REMOTE CONTROLLER

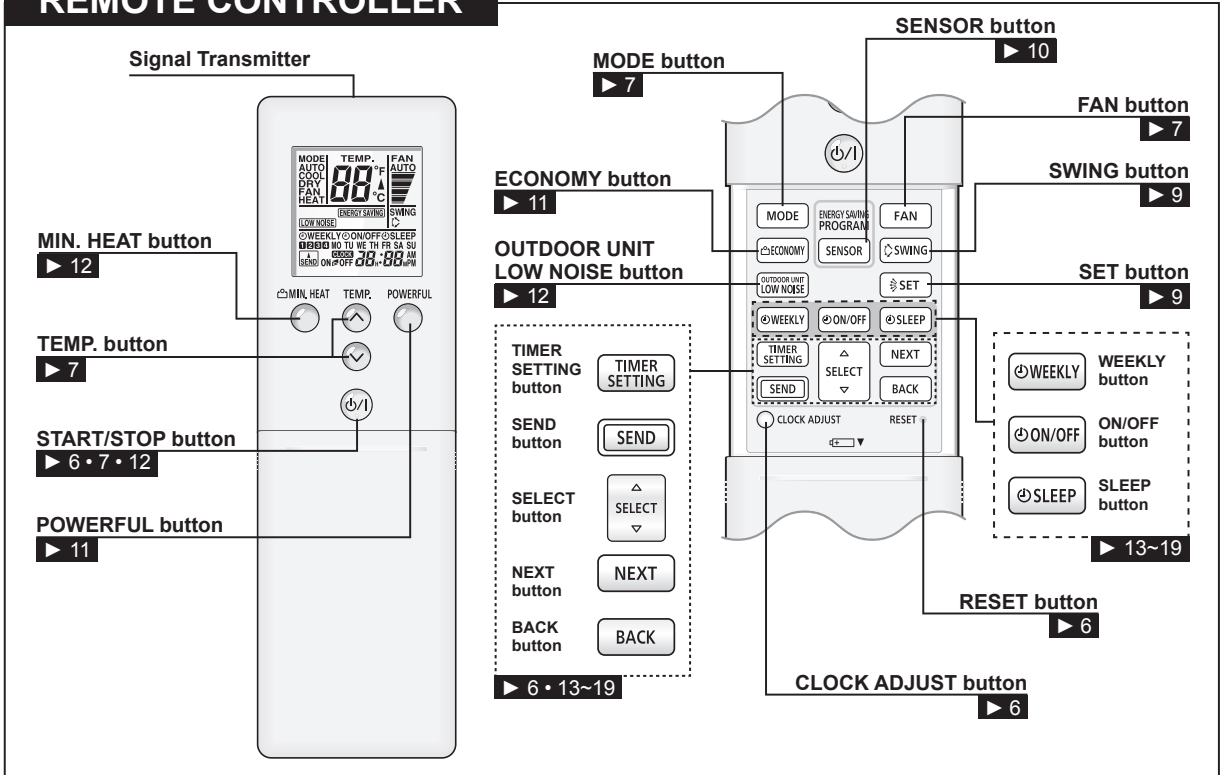

REMOTE CONTROLLER DISPLAY

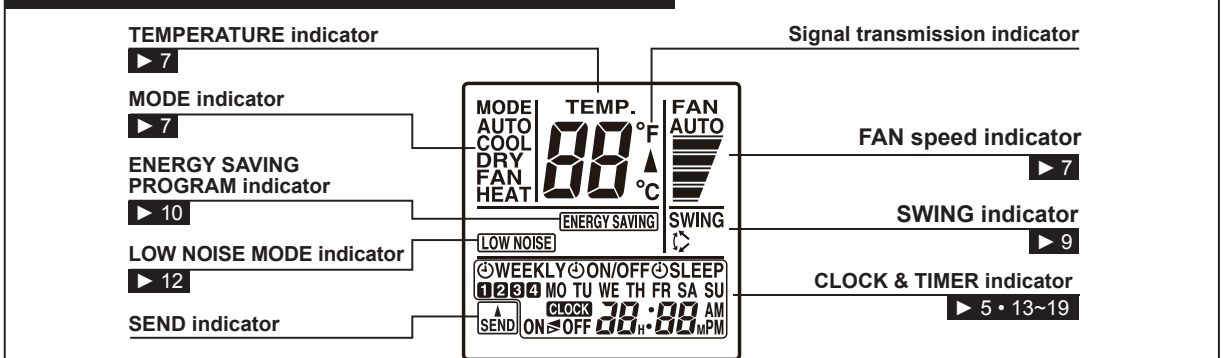

To facilitate explanation, the accompanying illustration has been drawn to show all possible indicators; in actual operation, however, the display will only show those indicators appropriate to the current operation.

■ About the button operation and display of remote controller

After the button is pressed on remote controller, only the operated part is displayed until the transmission of the signal is completed. It is a convenient function to confirm the content of the operation easily.

Ex.) When you change the preset temperature from 74°F to 78°F during the cooling operation.

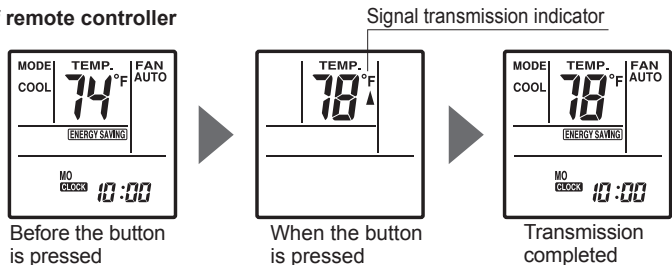

■ To change the temperature unit:

1. Press the TEMP. (Up) button (▲) for at least 5 seconds to display the current temperature unit. (Factory setting: °F)
2. Press the TEMP. buttons (▲/▼) to switch the temperature unit. (°F ↔ °C)
3. With either of pressing the START/STOP button or no additional button operation for 30 seconds in step 2., the temperature unit currently selected will be set.

PREPARATION

Turn on the Power

Turn on the circuit breaker

Load Batteries (AAA/R03/LR03 × 2)

1 Slide the front cover to take it off.

Slide in the direction of the arrow.

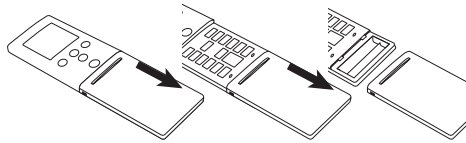

2 Insert batteries.

Be sure to align the battery polarities (+ / -) correctly.

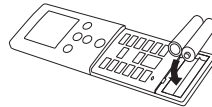

3 Close the front cover.

Set the day of the week and the current time

1 Press the CLOCK ADJUST button CLOCK ADJUST.

2 Press the SELECT button to select the day of the week

→MO ↔TU ↔WE ↔TH ↔FR ↔SA ↔SU←

Press the NEXT button 

3 Press the SELECT buttons to adjust the clock to the current time.

 button : Press to advance the time.

 button : Press to reverse the time.

(Each time the buttons are pressed, the time will be advanced/reversed in 1-minute increments; hold the buttons depressed to change the time quickly in 10-minute increments.)

4 Press the SEND button .

This completes the time setting and starts the clock.

- Press the SEND button, when you are close to the main unit. If you do so when far from the main unit, the signal may not get properly sent, and the settings may not get properly configured.

To Use the Remote Controller

- The Remote Controller must be pointed at signal receiver to operate correctly.
- Operating Range: About 20 ft.
- When a signal is properly received by the indoor unit, a beeping sound will be heard.
- If no beep is heard, press the Remote Controller button again.

Remote Controller Holder

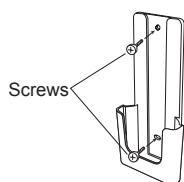

1 Mount the Holder.

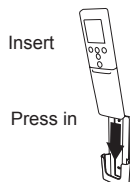

2 Set the Remote Controller.

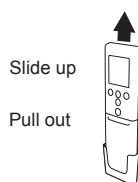

3 To remove the Remote Controller (when use at hand).

CAUTION

- Take care to prevent infants from accidentally swallowing batteries.
- When not using the Remote Controller for an extended period, remove the batteries to avoid possible leakage and damage to the unit.
- If leaking battery fluid comes in contact with your skin, eyes, or mouth, immediately wash with copious amounts of water, and consult your physician.
- Dead batteries should be removed immediately and disposed of properly, either in a battery collection receptacle or to the appropriate authority.
- Do not attempt to recharge dry batteries.

Never mix new and used batteries, or batteries of different types. Also, do not use together with rechargeable batteries or other types of battery. Batteries should last about 1 year under normal use. If the Remote Controller's operating range becomes appreciably reduced, replace the batteries and press the RESET button with the tip of a ball-point pen or other small object.

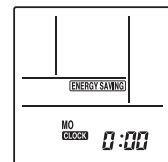

In the initial state (or, when resetting it), ENERGY SAVING becomes enables. (See page 10.)

CAUTION

- If there is a curtain or a wall between the remote control and the receptor, the signal will not reach it.
- When the receptor receives strong light, the air-conditioner may not operate correctly. Avoid direct exposure to sunlight, and keep the signal-receiving part away from lights and flat panel television screens. The signal may not be received in rooms with instantaneous fluorescent lights (such as inverter type ones). In such cases, please consult at the store where you purchased the product.
- Please place the remote control in a place which will not be affected by heat from direct sunlight and home heaters.
- Please do not apply strong shocks to the remote controller or pour water on it.

OPERATION

To Start Operation

Press the **START/STOP** button .

The indoor unit's OPERATION Indicator Lamp (green) will light.
The air conditioner will start operating.

To Select Mode Operation

Press the **MODE** button  to select the desired mode.

Each time the button is pressed, the mode will change in the following order.



About 3 seconds later, the entire display will reappear.

To Set the Temperature

Press the **TEMP.** button  .

- ^ button: Press to raise the temperature settings.
- v button: Press to lower the temperature settings.

● Temperature setting range:

AUTO	64–88 °F (18–30°C)
COOL/DRY	64–88 °F (18–30°C)
HEAT	60–88 °F (16–30°C)

The temperature cannot be used to set room temperature during the FAN mode (the temperature will not appear on the Remote Controller's Display).

About 3 seconds later, the entire display will reappear.

The temperature setting should be considered a standard value, and may differ somewhat from the actual room temperature.

To Set the Fan Speed

Press the **FAN** button .

Each time the button is pressed, the fan speed changes in the following order:



About 3 seconds later, the entire display will reappear.

When set to AUTO:

- Heating:** Fan operates so as to optimally circulate warmed air.
However, the fan will operate at very low speed when the temperature of the air issued from the indoor unit is low.
- Cooling:** As the room temperature approaches that of the temperature setting, the fan speed becomes slower.
When the room temperature is close to the set temperature, the inner room fan may occasionally stop, in order to save energy.
- Fan :** The fan runs at the MED fan speed.

SUPER QUIET Operation

SUPER QUIET operation begins. The indoor unit's airflow will be reduced for quieter operation.

- SUPER QUIET operation cannot be used during DRY mode. (The same is true when dry mode is selected during AUTO mode operation.)
- During SUPER QUIET operation, Heating and Cooling performance will be reduced somewhat. If the room does not warm up/cool down when using SUPER QUIET Operation, please adjust the indoor unit's Fan Speed.

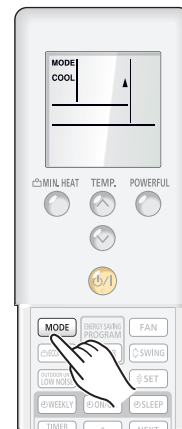

Example: When set to COOL.



Example: When set to 78 °F.



Example: When set to AUTO.

OPERATION

About AUTO CHANGEOVER Operation

AUTO: ● When AUTO CHANGEOVER operation first selected, the fan will operate at very low speed for about a few minutes, during which time the indoor unit detects the room conditions and selects the proper operation mode.

Room temperature is higher than the defined temperature in temperature setting → Cooling mode or dry mode

Room temperature is close to the defined temperature in temperature setting → Determined by outdoor temperature

Room temperature is lower than the defined temperature in temperature setting → Heating mode

- When the indoor unit has adjusted your room's temperature to near the temperature setting, it will begin monitor operation. In the monitor operation mode, the fan will operate at low speed. If the room temperature subsequently changes, the indoor unit will once again select the appropriate operation (Heating, Cooling) to adjust the temperature to the value set in the temperature.
- If the mode automatically selected by the indoor unit is not what you wish, select one of the mode operation (HEAT, COOL, DRY, FAN).

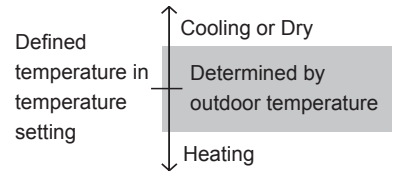

About Mode Operation

Heating: ● Use to warm your room.

- When Heating mode is selected, the indoor unit will operate at very low fan speed for about 3 to 5 minutes, after which it will switch to the selected fan setting. This period of time is provided to allow the indoor unit to warm up before begin full operation.
- When the outdoor temperature is very low, frost may form on the outdoor unit, and its performance may be reduced. In order to remove such frost, the air conditioner will automatically enter the defrost cycle from time to time. During Automatic Defrosting operation, the OPERATION Indicator Lamp will flash, and the Heat operation will be interrupted.
- After the start of Heating operation, it takes some time before the room gets warmer.

Cooling: ● Use to cool your room.

Dry: ● Use for gently cooling while dehumidifying your room.

- You cannot heat the room during Dry mode.
- During Dry mode, the indoor unit will operate at low speed; in order to adjust room humidity, the indoor unit's fan may stop from time to time. Also, the fan may operate at very low speed when adjusting room humidity.
- The fan speed cannot be changed manually when Dry mode has been selected.

Fan: ● Use to circulate the air throughout your room.

During Heating:

Set the temperature to a temperature setting that is higher than the present room temperature. The Heating mode will not operate if the temperature is set lower than the actual room temperature.

During Cooling/Dry:

Set the temperature to a temperature setting that is lower than the present room temperature. The Cooling and Dry modes will not operate if the temperature is set higher than the actual room temperature (in Cooling mode, the fan alone will operate).

During Fan:

You can not use the indoor unit to heat and cool your room.

To Stop Operation

Press the **START/STOP button**  .

The OPERATION Indicator Lamp (green) will go out.

ADJUSTING THE DIRECTION OF AIR CIRCULATION

Vertical (up-down) direction of airflow is adjusted by pressing the Remote Controller's SET button. Horizontal (right-left) airflow direction is adjusted manually, by moving the Airflow Direction Louvers.

Whenever making horizontal airflow adjustments, start air conditioner operation and be sure that the vertical air direction louvers are stopped.

Vertical Air Direction Adjustment

Press the SET button  .

Each time the button is pressed, the air direction range will change as follows:

1 ↔ 2 ↔ 3 ↔ 4 ↔ 5 ↔ 6 ↔ 7

Types of Airflow Direction Setting:

1, 2, 3 : During Cooling/Dry

4, 5, 6, 7 : During Heating

The Remote Controller's display does not change.

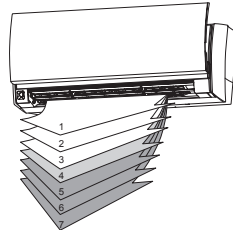

- Use the air direction adjustments within the ranges shown above.
- The vertical airflow direction is set automatically as shown, in accordance with the type of operation selected.

During Cooling/Dry : Horizontal flow 1

During Heating : Downward flow 6

- During AUTO mode operation, for the first a few minutes after beginning operation, airflow will be horizontal 1; the air direction cannot be adjusted during this period.

The airflow direction setting will temporarily become 1 when the temperature of the airflow is low at the start of the Heating mode.

Right-Left Adjustment

Adjust the Right-Left louvers.

- Move the Right-Left louvers to adjust airflow in the direction you prefer.

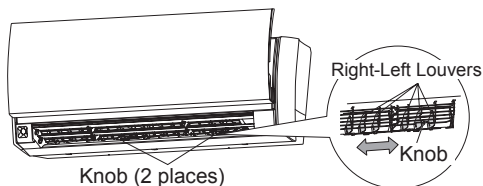

SWING OPERATION

The product moves the airflow vents up and down to move cool or warm air around all parts of the room.

To select SWING Operation

Press the SWING button  .

The SWING indicator "t-SWING" will light.

In this mode, the Airflow Direction Louvers will swing automatically to direct the airflow both up and down.

To stop SWING Operation

Press the SWING button  once again.

The SWING indicator "t-SWING" will go out.

Airflow direction will return to the setting before swing was begun.

About SWING Operation

During Cooling/Dry : Swings between 1 and 4.

During Heating : Swings between 4 and 7.

- The SWING operation may stop temporarily when the air conditioner's fan is not operating, or when operating at very low speeds.

⚠ DANGER

- Never place fingers or foreign objects inside the outlet ports, since the internal fan operates at high speed, and personal injury could be caused.

- Always use the Remote Controller's SET button to adjust the vertical airflow louvers. Attempting to move them manually could result in improper operation; in this case, stop operation and restart. The louvers should begin to operate properly again.

- During use of the Cooling and Dry modes, do not set the Airflow Direction Louvers in the Heating range (4 - 7) for many hours, since water vapor may condense near the outlet louvers and drops of water may drip from the indoor unit. During the Cooling and Dry modes, if the Airflow Direction Louvers are left in the heating range for more than 30 minutes, they will automatically return to position 3.

- When used in a room with infants, children, elderly or sick persons, the airflow direction and room temperature should be considered carefully when making settings.

⚠ CAUTION

- When adjusting the Right-Left Louvers, it is necessary to stop the Vertical (up-down) louvers first and make sure that it stops completely before adjusting the direction.

ENERGY SAVING PROGRAM

This program automatically controls the temperature setting when there is no one in the room for a while, and prevents electricity from being wasted.

To enable the ENERGY SAVING

ENERGY SAVING is set at the time of purchase.

Press the **SENSOR** button .

“**ENERGY SAVING**” on the remote controller will be displayed flashing.

- ENERGY SAVING is set.
- It will be on until the ENERGY SAVING setting is turned off.

To disable the ENERGY SAVING

Press the **SENSOR** button .

“**ENERGY SAVING**” on the remote controller will be no longer displayed.

- ENERGY SAVING is turned off.

About the ENERGY SAVING Operation

If no one enters the room for approximately 20 minutes, the set temperature will be automatically controlled.

(When someone comes back into the room, the human sensor will detect this, and automatically revert to the original settings.)

Operation mode	Operating details (if there is no one in the room for a while)
Cooling mode/Drying	The set temperature will be increased by a maximum of approximately 4 °F (2 °C).
Heating mode	The set temperature will be decreased by a maximum of approximately 8 °F (4 °C).
Automatic operation	This runs the ENERGY SAVING program for the automatically selected mode (Cooling/ Heating/ Drying).

- Application range is follows.
Vertical angle 90° (Side view)

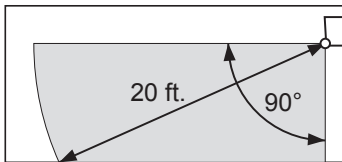

- Horizontal angle 100° (Top view)

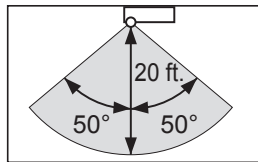

ENERGY SAVING program may not work when the room temperature is very different from the temperature defined in temperature setting, such as when immediately after starting the operation.

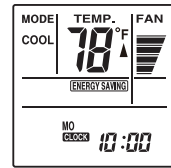

(If ENERGY SAVING is set)

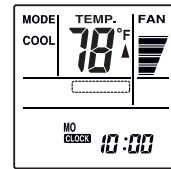

(If ENERGY SAVING is off)

- When using together with the SLEEP TIMER (P. 15), the SLEEP TIMER will be prioritized.
- During MIN. HEAT OPERATION, if there is no one in the room the set temperature will not be changed.

About the HUMAN SENSOR

- Details about detection with the human sensor
 - The human sensor detects whether there are people in the room by looking for movement by people in the room.

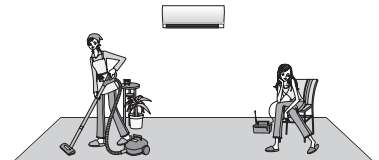

Notice

- Since the human sensor detects infrared light given out by people, there may be cases where this detection is incorrect.

Situations in which the sensor will detect no people in the room, even when there is someone there

- When the temperature is high and the difference with between people's body temperature is small.
(Such as during the summer when the temperature is 88 °F (30 °C) or higher)
- When there is someone in the room, but they do not move for a long period of time.
- When someone is hidden behind a sofa, other furniture, glass, or in similar situations.
- When someone is wearing extremely thick clothing and has their back facing the sensor.

Situations in which the sensor will incorrectly detect people in the room, even when there is no one there

- When there is a dog or a cat moving around in the room.
- When the wind is making curtains or plan leaves move.
- When there is an oscillating electric fan operating.

POWERFUL OPERATION

The product will operate at maximum power, which is convenient when you want to quickly cool down or warm up the room. Begin Air Conditioner operation before performing this procedure.

To use POWERFUL Operation

Press the **POWERFUL** button .

Only as for this button operation, the beep sound is different from the others.

Powerful operation start: Beep 3 times (Pi Pi Pi !) / Others: Beep 2 times (Pi Pi !)

To stop POWERFUL Operation

Press the **POWERFUL** button  again.
Normal operation begins.

About the POWERFUL Operation

Cooling/Dry ● Powerful Operation mode is automatically turned off when the room temperature has fallen to the set temperature or when 20 minutes have passed after setting the POWERFUL Operation mode. However, it does not turn off automatically within a certain time of setting the POWERFUL Operation mode.

Heating ● Powerful Operation mode is automatically turned off when the room temperature has risen to the set temperature or when 20 minutes have passed after setting the POWERFUL Operation mode. However, it does not turn off automatically within a certain time of setting the POWERFUL Operation mode.

- Wind direction and airflow rate are automatically set in POWERFUL Operation mode. Wind direction can be changed through the wind direction adjustment button.
- POWERFUL Operation and ECONOMY Operation modes can't be set simultaneously. The function whose button on the remote controller is last pressed will be given priority.
- If the POWERFUL Operation is set while setting the "LOW NOISE" or "ENERGY SAVING", "LOW NOISE" or "ENERGY SAVING" will be executed after the POWERFUL Operation ends.

ECONOMY OPERATION

Begin Air Conditioner operation before performing this procedure.

To Use the ECONOMY Operation

Press the **ECONOMY** button .

The ECONOMY indicator Lamp (green) will light.
ECONOMY operation begins.

To Stop the ECONOMY Operation

Press the **ECONOMY** button  again.
The ECONOMY Indicator Lamp (green) will go out.
Normal operation begins.

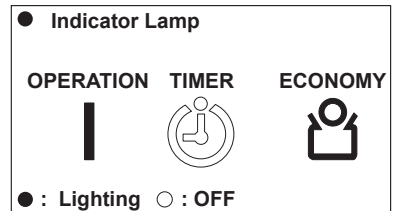

About ECONOMY Operation

- When ECONOMY operation mode is operated, the room temperature will be little higher than the set-temp under cooling mode and lower than set-temp under heating mode. Therefore, the ECONOMY mode is able to save more energy than other normal mode.
- In case of single-type air conditioner, at the maximum output, ECONOMY operation is approximately 70% of normal air conditioner operation for cooling and heating.
- In case of multi-type air conditioner, the ECONOMY operation mode is only available for the set indoor unit.
- If the room is not cooled (or heated) well during ECONOMY operation, select normal operation.
- During the monitor period in the AUTO mode, the air conditioner operation will not change to ECONOMY operation even if ECONOMY operation is selected by pressing the ECONOMY operation button.

MIN. (Minimum) HEAT OPERATION

To use MIN. HEAT Operation

 MIN. HEAT

Press the MIN. HEAT button .

The ECONOMY indicator lamp (green) will light.

To stop MIN. HEAT Operation

Press the START/STOP button .



The ECONOMY indicator lamp (green) will go out.
Then the operation stops.

About the MIN. HEAT Operation

- The Heating mode will not operate if the room temperature is high enough.
- The room temperature can be maintained at 50 °F (10 °C) by pressing the MIN. HEAT button  so as to prevent the room temperature from falling too far.
- In case of multi-type air conditioner, if other indoor unit is used for heating, the temperature of the room where the "MIN. HEAT" function is applied will rise. When using the "MIN. HEAT" function, we recommend all indoor units should be run under the "MIN. HEAT" mode.

While MIN. HEAT OPERATION is in progress, only the following operation can be used.

-  SET

● Indicator Lamp		
OPERATION	TIMER	ECONOMY
		
● : Lighting	○ : OFF	

OUTDOOR UNIT LOW NOISE OPERATION

OUTDOOR UNIT LOW NOISE Operation mode reduces the noise level of the outdoor unit by suppressing the fan speed and the rotation number of the compressor.

It is effective when the surrounding area is quiet, such as in the night.

To use the OUTDOOR UNIT LOW NOISE Operation

Press the OUTDOOR UNIT LOW NOISE button .

"LOW NOISE" appears on the Remote Controller display .

To stop the OUTDOOR UNIT LOW NOISE Operation

Press the OUTDOOR UNIT LOW NOISE button .

"LOW NOISE" disappears from the Remote Controller display .

Normal operation begins.

About OUTDOOR UNIT LOW NOISE Operation

- OUTDOOR UNIT LOW NOISE Operation mode can be used during cooling, heating and automatic operation. It can not be used in FAN and DRY mode.
- OUTDOOR UNIT LOW NOISE Operation setting is saved even if the air-conditioned is stopped. Display on the remote control is also retained.
- When the fan speed and the rotation number of the compressor of the outdoor unit have sufficiently reduced, OUTDOOR UNIT LOW NOISE Operation mode does not further reduce the fan speed and the rotation number of the compressor.
- Moreover, if the POWERFUL Operation is set while setting the "LOW NOISE" or "ENERGY SAVING", "LOW NOISE" or "ENERGY SAVING" will be executed after the POWERFUL Operation ends.
- When outdoor air temperature is high, it may not be operated even if it has been set.
- When compressor rotational speed and fan speed are low enough, it may not be operated even if it has been set.
- This function cannot be used for the Multi-type air conditioner. Please release it when it is set. Otherwise the signal of wireless remote controller cannot be received.

MANUAL AUTO OPERATION

Use the MANUAL AUTO operation in the event the Remote Controller is lost or when the battery runs out.

How To Use the Main Unit Controls

Press the MANUAL AUTO button  more than 3 seconds and less than 10 seconds on indicator.

To stop operation, press the MANUAL AUTO button  for 3 seconds.

About the MANUAL AUTO button , please see page 4.

- When the air conditioner is operated by the controls on the MANUAL AUTO button, it will operate under the same mode as the AUTO mode selected on the Remote Controller (see page 8).
- The fan speed selected will be "AUTO" and the temperature setting will be standard [76 °F (24 °C)].

ON/OFF TIMER OPERATION

- ON TIMER : The air conditioner will start at the time you set.
- OFF TIMER : The air conditioner will stop at the time you set.
- Before using the timer function, be sure that the Remote Controller is set to the correct current time.

To use the ON timer or OFF timer

- 1 Press the **TIMER SETTING** button  .



At the beginning, “⏻ WEEKLY” will be flashing, so press the **SELECT** button  to select either “ON” or “OFF” within “⏻ ON/OFF”.

Press the **NEXT** button  .

- 2 Press the **SELECT** button  to set the desired On time or OFF timer.

- 3 Press the **SEND** button  .

In the case of the ON timer, the air conditioner will stop running.

If you want to cancel the setting midway, please press the **TIMER SETTING** button  instead of pressing the **SEND** button  .

To cancel the ON timer or OFF timer

- 1 Press the **ON/OFF** button  while “⏻ ON/OFF” is displayed.

- 2 “⏻ ON/OFF” will disappear from the display.

- Press the ON/OFF button  while “⏻ ON/OFF” is not displayed to set the ON (OFF) TIMER again for the time you set last time.
- You cannot combine WEEKLY TIMER, ON/OFF TIMER (PROGRAM TIMER), and SLEEP TIMER.



“⏻ ON/OFF” • “ON” or “OFF” will be flashing

To Stop Air Conditioner Operation while the Timer is Operating

Press the **START/STOP** button  .

PROGRAM TIMER OPERATION

- The program timer allows you to integrate OFF timer and ON timer operations in a single sequence. The sequence can involve 1 transition from OFF timer to ON timer, or from ON timer to OFF timer, within a 24 hour period.
- Before using the timer function, be sure that the Remote Controller is set to the correct current time.

To use the PROGRAM Timer

1 Press the **TIMER SETTING** button  .

At the beginning, “ WEEKLY” will be flashing, so press the **SELECT** button  to select “ONOFF” within “ ON/OFF”.

Press the **NEXT** button  .

2 Press the **SELECT** button  to set the desired ON time.

Press the **NEXT** button  .

3 Press the **SELECT** button  to set the desired OFF time.

4 Press the **SEND** button  .

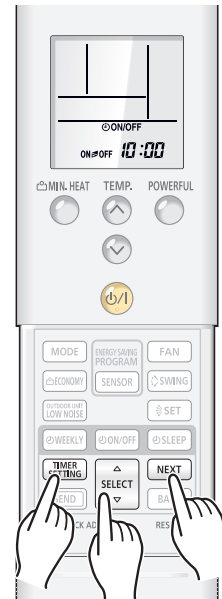



Flashing the “ ON/OFF” · “ONOFF”.

To Stop Air Conditioner Operation while the Timer is Operating

Press the **START/STOP** button .





In the case of the ON timer, the air conditioner will stop running.

If you want to cancel the setting midway, please press the **TIMER SETTING** button  instead of pressing the **SEND** button .

To cancel the PROGRAM timer

1 Press the **ON/OFF** button  while “ ON/OFF” is displayed.

2 “ ON/OFF” will disappear from the display.

- Press the ON/OFF button  while “ ON/OFF” is not displayed to set the ON (OFF) TIMER again for the time you set last time.
- Only run operation once with the OFF TIMER and ON TIMER combined. (Either OFF → ON or ON → OFF once)
- Out of OFF TIMER and ON TIMER, the timer which has the nearest set time to the present will run first. You can display the sequence of operation by using the arrows on the display part of the remote control (“” or “”).
- You cannot combine WEEKLY TIMER, ON/OFF TIMER (PROGRAM TIMER), and SLEEP TIMER.
- The PROGRAM TIMER cannot be set for times more than 24 hours in advance.

SLEEP TIMER OPERATION

You can set the OFF TIMER to any time you want when you go to sleep.
 The product adjusts the temperature to make it suitable for sleeping, which helps you sleep comfortably.
 Once you set the time you want, you can easily set the timer to run from the next time, simply by pressing the SLEEP button  once.



To use the SLEEP timer

- 1 Press the **TIMER SETTING** button .
 “WEEKLY” will be firstly displayed flashing.
 Press the **SELECT** button  to select “SLEEP”.
 Press the **NEXT** button .

- 2 Press the **SELECT** button  to set the OFF time.

△ button:	(30 min) → 0.5H → 1H → 2H → 3H → 5H → 7H → 9H
▽ button:	9H → 7H → 5H → 3H → 2H → 1H → 0.5H (30 min)

- 3 Press the **SEND** button .

If you want to cancel the setting midway, please press the **TIMER SETTING** button  instead of pressing the **SEND** button .

To cancel the SLEEP timer

- 1 Press the **SLEEP** button  while “SLEEP” is displayed.
- 2 “SLEEP” will disappear from the display.

About the SLEEP timer

To prevent excessive warming or cooling during sleep, the SLEEP timer function automatically modifies the temperature setting in accordance with the set time setting. When the set time has elapsed, the air conditioner completely stops.

During Heating operation:

When the SLEEP timer is set, the temperature setting is automatically lowered 2 °F (1 °C) every 30 minutes. When the temperature setting is lowered a total of 8 °F (4 °C), the temperature setting at that time is maintained until the set time elapses, at which time the air conditioner automatically turns off.

SLEEP timer setting

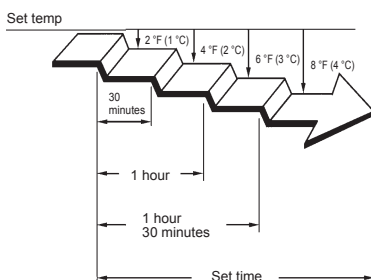

During Cooling/Dry operation:

When the SLEEP timer is set, the temperature setting is automatically raised 2 °F (1 °C) every 1 hour. When the temperature setting is raised a total of 4 °F (2 °C), the temperature setting at that time is maintained until the set time elapses, at which time the air conditioner automatically turns off.

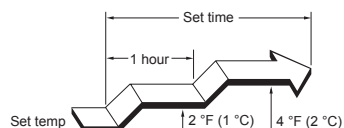

SLEEP timer setting



Flashing the “OFF” · “SLEEP”.

To Stop Air Conditioner Operation while the Timer is Operating

Press the **START/STOP** button .

- When you press the **SLEEP** button  while SLEEP is no longer displayed, the SLEEP TIMER you set last time will be set again.
- The WEEKLY TIMER, ON/OFF TIMER (program timer) and SLEEP TIMER cannot be combined.

WEEKLY TIMER OPERATION

Using in these cases of WEEKLY timer

The "OFF Timer" at which the operation will be stopped and the "ON Timer" at which the operation will be started can be combined, and up to 4 reservations (program 1~4) can be applied for one day, and 28 reservations for a week. Before creating the program, please adjust the week and time first, and then send it to the air conditioner. If the week and time are not adjusted, the program will not be operated at the set time. Please refer to [Set the day of the week and current time] (page 6).

Once you set this, the set operation will run on every day and every week.

Example of how to set the timer 1

Monday to Friday

Program 1 Set the ON Timer with a temperature of 72°F (22°C) for 7:00 AM. Program 2 Set the OFF timer for 9:00 AM.

Program 3 Set the ON Timer with a temperature of 78°F (26°C) for 5:00 PM. Program 4 Set the OFF timer for 11:00 PM.

Saturday

Program 1 ~ 4 No timer settings.

Sunday

If you set the OFF Timer for Program 1 at 9:00 AM, Program 2 at 11:00 AM, Program 3 at 5:00 PM, and Program 4 at 11:00 PM.

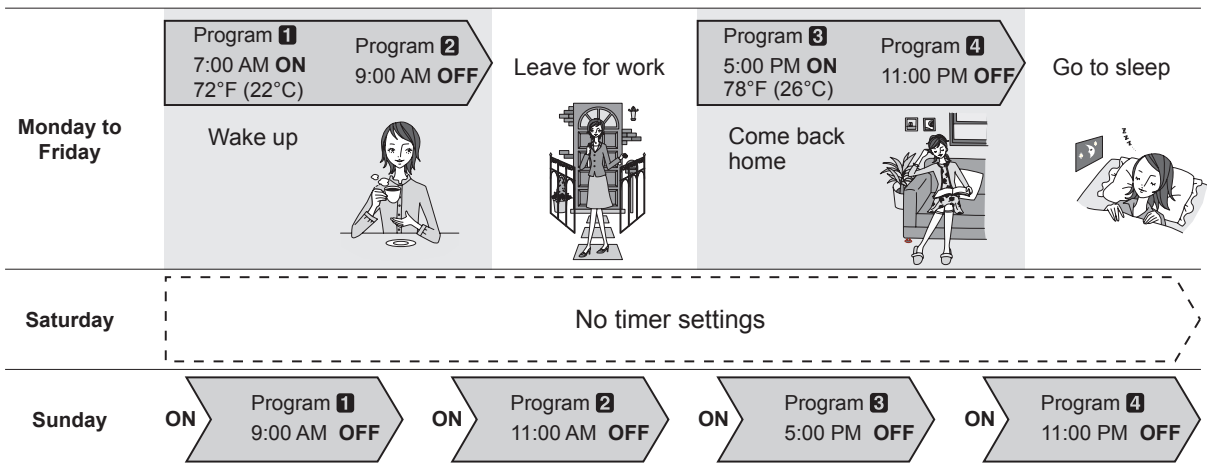

Example of how to set the timer 2

You can specify a given temperature in the ON setting in WEEKLY TIMER.

* You can set the temperature for Auto, Cool, and Dry within the range 64–88 °F (18-30 °C), for Heat the range is 50 or 60–88°F (10 or 16-30 °C).

Even if you set 50, 60, or 62 °F (10, 16, or 17 °C), if you run the product on Auto, Cool, or Dry it will run at 64 °F (18 °C).

During the heating season, even if you configure detailed settings with the temperature low when there is no one in the room and high when there is someone there, the air conditioning will automatically switch over.

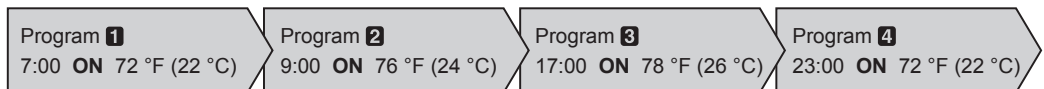

CAUTION

- Operations other than the temperature setting will be the same as the last time operation was stopped, so Cooling → Heating → Cooling → Heating type of operations cannot be automatically set.
- If you set the ON Timer and OFF Timer on the same day and for the same time, the air conditioner will run the ON Timer. If two ON Timers are set at the same time, the air-conditioning will run the program that was set earlier.
- If there is a power interrupting, such as due to a power outage during the WEEKLY timer setting or a circuit breaker cutting out, the internal timer of the air-conditioning will be incorrect. (See "AUTO Restart" on page 23.) In such a case, the main timer lamp will notify you of this by flashing, so carry out matching of the time and date. (See "Set the day of the week and current time" on page 6.)
- You cannot use the ON/OFF together with the SLEEP timer.
If you want to run the product on WEEKLY TIMER after the time is up after using the ON/OFF Timer, Program Timer, or SLEEP Timer within the WEEKLY TIMER, you need to set the WEEKLY TIMER again. (See page 19.)

WEEKLY TIMER OPERATION

To use WEEKLY timer operation

1 Press the **TIMER SETTING** button  .

Firstly, since “WEEKLY” will be flashing.

Press the **NEXT** button  .

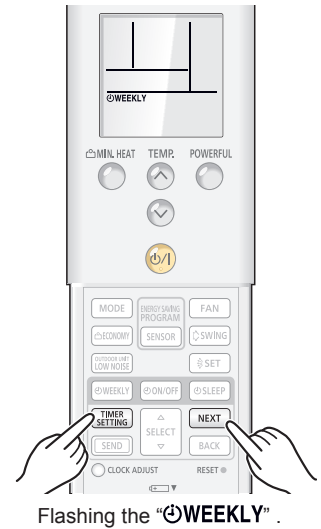

2 Select the program and the day using the **SELECT** button  .

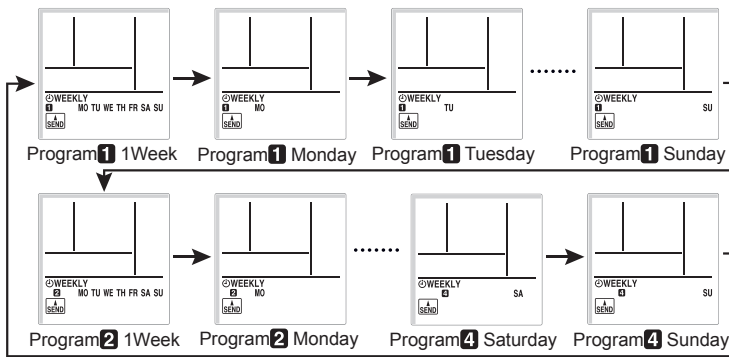

Press the **NEXT** button  , when the program number and day you want to set are flashing.



3 Using the **SELECT** button  select operation with the **ON** Timer, **OFF** Timer, or without a timer.

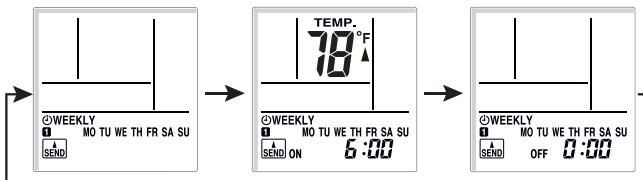

To operate without a timer

1. Press the **NEXT** button  to go back to step 2 and configure the next setting.

2. Press the **SEND** button  to finish

Press the **NEXT** button  .



WEEKLY TIMER OPERATION

4 Press the **SELECT** button  to set the desired **ON** time or **OFF** time.

If you selected OFF in step 3

1. Press the **NEXT** button  to go back to step **2** and configure the next setting.
2. Press the **SEND** button  .

Press the **NEXT** button  .

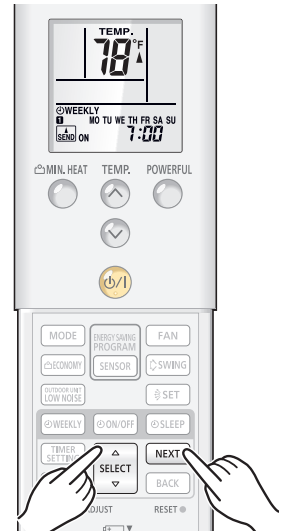



The time indicator / "SEND" will be flashing

5 Press the **SELECT** button  to set the temperature.

If you want to move on to the next setting, press the **NEXT** button  , return to step **2** and configure the next setting.

To complete the setting, Press the **SEND** button  .



If you want to cancel the setting midway, please press the **TIMER SETTING** button  instead of pressing the **SEND** button  .



The temperature indicator / "SEND" will be flashing



CAUTION

- When canceling the WEEKLY TIMER, select No Timer Operation in Step 3 in To use WEEKLY TIMER Operation.
- If you want to go back to the previous step will configuring settings, press the **BACK** button  to return to the previous step.
- Press the **SEND** button  , when you are close to the main unit. If you do so when far from the main unit, the signal may not get properly sent, and the settings may not get properly configured.

WEEKLY TIMER OPERATION

Check the schedule

1 Press the **TIMER SETTING** button  .

Firstly, since “**⌚WEEKLY**” will be flashing.

Press the **NEXT** button  .

2 Check the program, the day, and the time with the

SELECT button  .

3 Press the **TIMER SETTING** button  to return to the regular screen.



To cancel the WEEKLY timer

1 Press the **WEEKLY** button  when “**⌚WEEKLY**” is displayed.

2 “**⌚WEEKLY**” will disappear from the display.

- When “**⌚WEEKLY**” is not shown, press the **WEEKLY** button  to set the WEEKLY TIMER again.
- You cannot combine WEEKLY TIMER, ON/OFF TIMER (PROGRAM TIMER), and SLEEP TIMER.

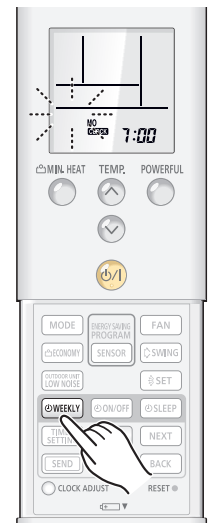

CLEANING AND CARE

⚠ CAUTION

- Before cleaning the indoor unit, be sure to turn it off and disconnect the electrical breaker and so on.
- Be sure the Intake Grille is installed securely.
- When removing or replacing the air filters, be sure not to touch the heat exchanger, as personal injury may result.
- Do not operate the air conditioner with being opened the intake grille.

Open the Intake Grille

1. The tab on both sides of the intake grille is pulled forward.

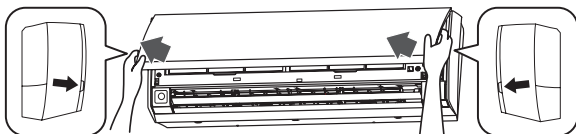

Do not open the Open Panel only.

Good

PROHIBITED

Open Panel

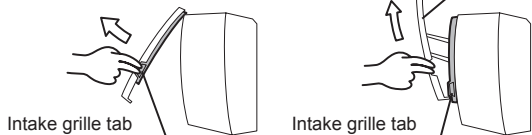

2. Fix the intake grille with the grille stay.

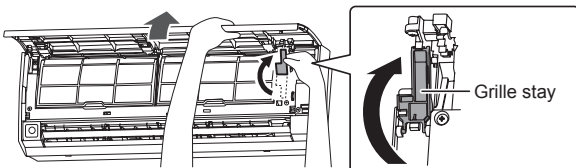

Cleaning the Air Filters

1. Remove the air filters.

Lift up the air filter handle, disconnect the 2 lower tabs, and pull out.

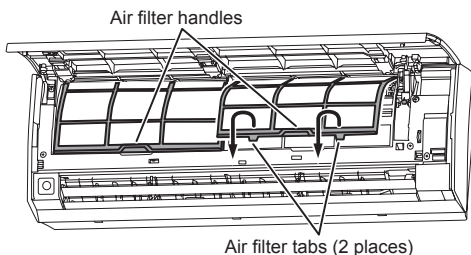

Air filter tabs (2 places)

2. Remove dust with a vacuum cleaner or by washing.

- Dust can be cleaned from the air filter either with a vacuum cleaner, or by washing the filter in a solution of neutral detergent and warm water. If you wash the filter, be sure to allow it to dry thoroughly in a shaded place before reinstalling.
- If dust is allowed to accumulate on the air filter, airflow will be reduced, lowering operating efficiency and increasing noise.
- During periods of normal use, the Air Filters should be cleaned every 2 weeks.

3. Replace the air filters.

Align the sides of the air filter with the panel, and push in fully, making sure the 2 lower tabs are returned properly to their holes in the panel.

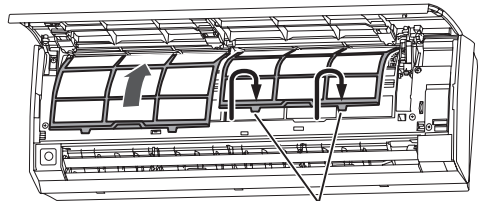

Air filter tabs (2 places)

Close the Intake Grille

1. Release the grille stay.

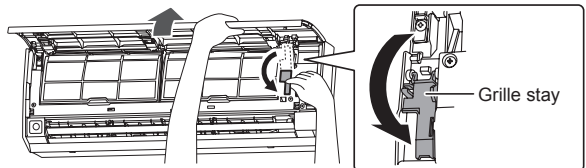

2. Close the intake grille. (Tab of 3 places.)

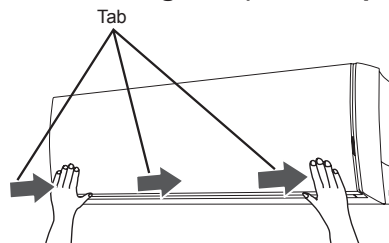

If the intake grille is not completely closed, the air-conditioner will not operate and the lamp will flash as shown below.

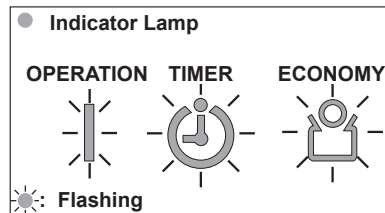

- Firstly, the Operation Lamp will flash 5 times, and then the Timer Lamp will flash 8 times, and this will be repeated.
- The Economy Lamp will continue to flash.

- When used for extended periods, the indoor unit may accumulate dust inside, reducing its performance. We recommend that the indoor unit be inspected regularly, in addition to your own cleaning and care. For more information, consult authorized service personnel.
- When cleaning the indoor unit's body, do not use water hotter than 104 °F (40 °C), harsh abrasive cleansers, or volatile agents like benzene or thinner.
- Do not expose the indoor unit's body to liquid insecticides or hair sprays.
- When shutting down the indoor unit for 1 month or more, first allow the fan mode to operate continuously for half a day to allow internal parts to dry thoroughly.

CLEANING AND CARE

Install or Replace the Air Cleaning Filter

1. Open the intake grille and remove the air filters.

Please refer to the page 20.

2. Remove the dirty air cleaning filters attached to the frames of the front panel. (When replacing)

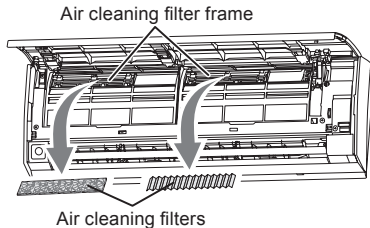

3. Attach the new (or maintained) air cleaning filters to the frame of the front panel.

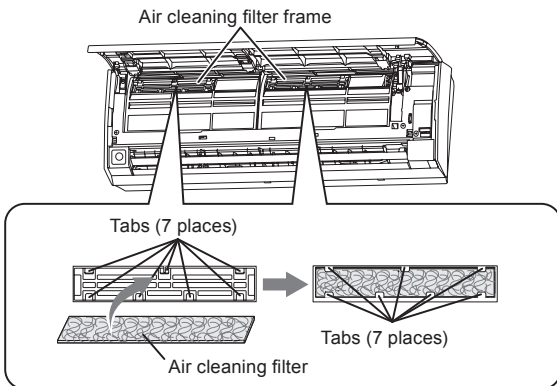

The new air cleaning filters can be attached to any of the right frame or the left frame.

Replace filters with the following components (purchased separately).

- POLYPHENOL CATECHIN AIR CLEANING FILTER : UTR-FA16
- NEGATIVE AIR IONS DEODORIZING FILTER: UTR-FA16-2

4. Install the air filters and close the intake grille.

Please refer to page 20.

About the Air Cleaning Filters

- When Air Cleaning Filters are used, the effect will increased by setting the fan speed to "High".

[POLYPHENOL CATECHIN AIR CLEANING FILTER]

(1 sheet)



- The Air Cleaning Filters are disposable filters. (They can not be washed and reused.)
- For storage of the Air Cleaning Filters, use the filters as soon as possible after opening the package. (The air cleaning effect decreases when the filters are left in the opened package)
- Generally, the filters should be exchanged about every 3 months.

Please buy dedicated air cleaning filters (UTR-FA16) (Sold separately) to exchange the used dirty air cleaning filter.

[NEGATIVE AIR IONS DEODORIZING FILTER (light blue)]

(1 sheet)

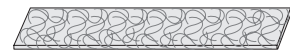

- The filter should be exchanged about every 3 years so as to maintain the deodorizing effect.
- Filter frame is not a one-off product.

Please buy dedicated deodorizing filter (UTR-FA16-2) (Sold separately) when exchanging the filter.

Maintenance of Deodorizing Filters

In order to maintain the deodorizing effect, please clean the filter in the follow way once 3 months.

- (1) Remove the deodorizing filter.
- (2) Clean with water and dry in the air.
 - 1) Flush the filter with high-pressure hot water until the surface of the filter is covered with water. Please flush with diluent neutral detergent. Never wash by reaming or rubbing, otherwise it will damage the deodorizing effect.
 - 2) Rinse with water flow.
 - 3) Dry in shade.
- (3) Reinstall the deodorizing filter.

Filter Indicator Reset (The special setting)

Can be used if set correctly during installation. Please consult authorized serviceman when using this function.

- ECONOMY lamp will flashing on when it is time to clean the air filters.

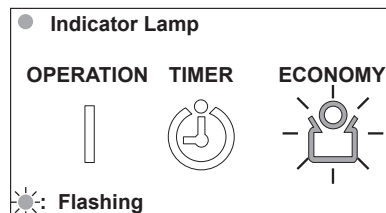

- Clean the air filters referring to page 20.
- After cleaning, press the MANUAL AUTO button  for 2 seconds or less on the indoor unit. (See page 4.)

TROUBLESHOOTING



WARNING

In the event of a malfunction (burning smell, etc.), immediately stop operation, turn off the electrical breaker and consult authorized service personnel.

Merely turning off the unit's power switch will not completely disconnect the unit from the power source. Always be sure to turn off the electrical breaker to ensure that power is completely off.

Before requesting service, perform the following checks:

	Symptom	Problem	See Page
NORMAL FUNCTION	Doesn't operate immediately:	<ul style="list-style-type: none"> ● If the indoor unit is stopped and then immediately started again, the compressor will not operate for about 3 minutes, in order to prevent fuse blowouts. ● Whenever the electrical breaker is turned off then on again the protection circuit will operate for about 3 minutes, preventing unit operation during that period. 	—
	Noise is heard:	<ul style="list-style-type: none"> ● During operation or immediately after stopping the unit, the sound of water flowing in the air conditioner's piping may be heard. Also, noise may be particularly noticeable for about 2 to 3 minutes after starting operation (sound of refrigerant flowing). ● During operation, a slight squeaking sound may be heard. This is the result of minute expansion and contraction of the front panel due to temperature changes. 	—
		<ul style="list-style-type: none"> ● During Heating operation, a sizzling sound may be heard occasional. This sound is produced by the Automatic Defrosting operation. 	23
	Smells:	<ul style="list-style-type: none"> ● Some smell may be emitted from the indoor unit. This smell is the result of room smells (furniture, tobacco, etc.) which have been taken into the indoor unit. 	—
	Mist or steam is emitted:	<ul style="list-style-type: none"> ● During Cooling or Dry operation, a thin mist may be seen emitted from the indoor unit. This results from the sudden Cooling of room air by the cool air emitted from the indoor unit, resulting in condensation and misting. 	—
		<ul style="list-style-type: none"> ● During Heating operation, the outdoor unit's fan may stop, and steam may be seen rising from the unit. This is due to Automatic Defrosting operation. 	23
	Airflow is weak or stops:	<ul style="list-style-type: none"> ● When Heating operation is started, fan speed is temporarily very low, to allow internal parts to warm up. ● During Heating operation, if the room temperature rises above the temperature setting, the outdoor unit will stop, and the indoor unit will operate at very low fan speed. If you wish to warm the room further, set the temperature for a higher setting. 	—
		<ul style="list-style-type: none"> ● During Heating operation, the indoor unit will temporarily stop operation (Max.15 minutes) as the Automatic Defrosting mode operates. During Automatic Defrosting operation, the OPERATION Indicator Lamp will flash. 	23
		<ul style="list-style-type: none"> ● During Dry mode, the indoor unit will operate at low speed; in order to adjust room humidity, the indoor unit's fan may stop from time to time. Also, the fan may operate at very low speed when adjusting room humidity. 	8
		<ul style="list-style-type: none"> ● During SUPER QUIET operation, the fan will operate at very low speed. 	7
		<ul style="list-style-type: none"> ● In the monitor of AUTO operation, the fan will operate at very low speed. 	8
		<ul style="list-style-type: none"> ● In case of Multi-type unit, if multiple units are operated in different operation modes as shown below, the units operated afterward will stop and the OPERATION indicator lamp (green) will flash. Heating mode and cooling mode (or Dry mode) Heating mode and fan mode 	24
	Water is produced from the outdoor unit:	<ul style="list-style-type: none"> ● During Heating operation, water may be produced from the outdoor unit due to Automatic Defrosting operation. 	23

TROUBLESHOOTING

	Symptom	Items to check	See Page
CHECK ONCE MORE	Doesn't operate at all:	<ul style="list-style-type: none"> ● Has the circuit breaker been turned off? ● Has there been a power failure? ● Has a fuse blown out, or a circuit breaker been tripped? 	—
		<ul style="list-style-type: none"> ● Is the intake grille completely closed? 	20
		<ul style="list-style-type: none"> ● Is the timer operating? 	13 - 19
		<ul style="list-style-type: none"> ● Is Multi-type air conditioner set to "LOW NOISE" with the wireless remote controller? 	12
	Poor Cooling (or Heating) performance:	<ul style="list-style-type: none"> ● Is the Air Filter dirty? ● Are the air conditioner's intake grille or outlet port blocked? ● Did you adjust the room temperature settings (temperature) correctly? ● Is there a window or door open? ● In the case of Cooling operation, is a window allowing bright sunlight to enter? (Close the curtains.) ● In the case of Cooling operation, are there heating apparatus and computers inside the room, or are there too many people in the room? 	—
		<ul style="list-style-type: none"> ● Has OUTDOOR UNIT LOW NOISE not been set? 	12
		<ul style="list-style-type: none"> ● Is the unit set for SUPER QUIET operation? 	7
The unit operates differently from the Remote Controller's setting:	<ul style="list-style-type: none"> ● Are the Remote Controller's batteries dead? ● Are the Remote Controller's batteries loaded properly? 	6	

If the problem persists after performing these checks, or if you notice burning smells, or the OPERATION Indicator Lamp and the TIMER Indicator Lamp flashes, and ECONOMY Indicator Lamp flashes fast. Immediately stop operation, turn off the electrical breaker and consult authorized service personnel.

OPERATING TIPS

Operation and Performance

Heating Performance

- This air conditioner operates on the heat-pump principle, absorbing heat from outdoor air and transferring that heat to indoor unit. As a result, the operating performance is reduced as outdoor air temperature drops. If you feel that insufficient heating performance is being produced, we recommend you use this air conditioner in conjunction with another kind of heating appliance.
- Heat-pump air conditioners heat your entire room by circulating air throughout the room, with the result that some time may be required after first starting the air conditioner until the room is heated.

Microcomputer-controlled Automatic Defrosting

- When using the Heating mode under conditions of low outdoor temperature and high humidity, frost may form on the outdoor unit, resulting in reduced operating performance. In order to prevent this kind of reduced performance, this air conditioner is equipped with a Microcomputer-controlled Automatic Defrosting function. If frost forms, the air conditioner will temporarily stop, and the defrosting circuit will operate briefly (Max. 15 minutes). During Automatic Defrosting operation, the OPERATION Indicator Lamp (green) will flash.
- After heating operation stops, if frost forms on the outdoor unit, the unit will start Automatic Defrosting operation. At this time, the outdoor unit will automatically stop after operating for a few minutes.

AUTO Restart

In Event of Power Interruption

- The power supply to the air conditioner is stopped by a power interruption. The air conditioner will then restart automatically in its previous mode when the power is restored.
- If a power interruption occurs during TIMER operation, the timer will be reset and the indoor unit will begin (or stop) operation at the new time setting. In the event that this kind of timer fault occurs, the TIMER Indicator Lamp will flash (see page 4.).
- Use of other electrical appliances (electric shaver, etc.) or nearby use of a wireless radio transmitter may cause the air conditioner to malfunction. In this event, temporarily turn off the circuit breaker, turn it on and then use the Remote Controller to resume operation.

OPERATING TIPS

Multi-type Air conditioner

This indoor unit can be connected to a multi-type outdoor unit depending on model. The multi-type air conditioner allows multiple indoor units to be operated in multiple locations. The indoor units may be operated simultaneously, in accordance with their respective output.

Simultaneous Use of Multiple Units

- When using a multi-type air conditioner, the multiple indoor units can be operated simultaneously, but when two or more indoor units of the same group are operated simultaneously, the heating and cooling efficiency will be less than when a single indoor unit is used alone. Accordingly, when you wish to use more than 1 indoor unit for cooling at the same time, the use should be concentrated at night and other times when less output is required. In the same way, when multiple units are used simultaneously for heating, it is recommended that they be used in conjunction with other auxiliary space heaters, as required.
- Seasonal and outdoor temperature conditions, the structure of the rooms and the number of persons present may also result in differences of operating efficiency. We recommend that you try various operating patterns in order to confirm the level of heating and cooling output provided by your units, and use the units in the way that best matches your family's lifestyle.
- If you discover that one or more units delivers a low level of cooling or heating during simultaneous operation, we recommend that you stop simultaneous operation of the multiple units.
- Operation cannot be done in the following different operating modes.
If the indoor unit is instructed to do an operating mode that it cannot perform, the OPERATION indicator lamp (green) on the indoor unit will flash (1 second on, 1 second off) and the unit will go into the standby mode.
 - Heating mode and cooling mode (or dry mode)
 - Heating mode and fan mode
- Operation can be done in the following different operating modes.
 - Cooling mode and Dry mode
 - Cooling mode and Fan mode
 - Dry mode and fan mode
- The operating mode (heating mode or cooling (dry) mode) of the outdoor unit will be determined by the operating mode of the indoor unit that was operated first. If the indoor unit was started in fan mode, the operating mode of the outdoor unit will not be determined.
For example, if indoor unit (A) was started in fan mode and then indoor unit (B) was then operated in heating mode, indoor unit (A) would temporarily start operation in fan mode but when indoor unit (B) started operating in heating mode, the OPERATION indicator lamp (green) for indoor unit (A) would begin to flash (1 second on, 1 second off) and it would go into standby mode. Indoor unit (B) would continue to operate in heating mode.

Notice

- During use of the heating mode, the outdoor unit will occasionally commence the defrost operation for brief periods. During the defrosting operation, if the user sets the indoor unit for heating again, the defrosting mode will continue, and the heating operation will begin after completion of defrosting, with the result that some time may be required before warm air is emitted.
- During use of the heating mode, the top of the indoor unit may become warm, but this is due to the fact that coolant is circulated through the indoor unit even when it is stopped; it is not a malfunction.