

AIRSTAGE

The Fujitsu logo, consisting of the word "FUJITSU" in a bold, red, sans-serif font. Above the letter "J" is a red infinity symbol.

Variable Refrigerant Flow Systems

AIRSTAGE VRF

Heat Pump and Heat Recovery



FUJITSU GENERAL AMERICA, INC

TABLE OF CONTENTS

Our Message.....	3
VRF Outdoor & Indoor Unit Intro	6
FEATURES	8
High Energy Efficiency	9
More Comfort.....	12
High Reliability.....	14
Design Flexibility.....	16
Easy Installation	18
Easy Service & Maintenance	20
MODEL LINEUP	
Indoor and Outdoor Model Table	22
OUTDOOR UNITS	
J-IV Heat Pump, 208-230V / 1-Phase	24
J-IVs Heat Pump, 208-230V / 1-Phase.....	28
J-IIIIL Heat Pump, 208-230V / 3-Phase.....	32
VU-V Heat Pump/ Heat Recovery 208-230V & 460V/3-Phase.....	36
INDOOR UNITS.....	44
Compact Cassette	46
Large Circular Flow Cassette.....	48
Slim Compact Duct	50
Medium Static Pressure Duct	52
High Static Pressure Duct (ARUH36, 48, 60)	54
High Static Pressure Duct (ARUH72, 96)	56
Multi-Position Air Handling Unit.....	58
Floor Mount.....	60
Floor/Ceiling	62
Ceiling	64
Compact Wall Mounts.....	66
Wall Mounts	68
DX Kit	70
VENTILATION	72
Outdoor Air Unit	73
HRV / ERV Solutions	75
CONTROL SYSTEMS & TOOLS.....	76
Control System Overview	78
Remotes & Controllers Features Table.....	80
Individual Controls.....	81
Centralized Controllers.....	87
BMS Gateways	95
Wi-Fi Interfaces.....	99
Converters/Adapters	100
Service & Design Tools.....	103
OPTIONAL PARTS OVERVIEW	110
Separation Tubes	112
RB Units.....	113
Auto Louver Grille Kit.....	114
Wind Baffles, Hail Guards, SNow Hoods.....	115
Airzone.....	116
Hi-Rise 360.....	118
APPLICATIONS / RESOURCES.....	119
Facility Applications.....	119
Commercial Financing	124
Warranty and General Info.....	125

AIRSTAGE

Variable Refrigerant Flow System For Small and Large Buildings

- Extensive lineup from 3 to 36 tons
- Connectable capacity ratio up to 150%
- 58 different indoor units available in 13 styles
- Up to 64 indoor units for 24 Ton and larger systems
- Three outdoor V-Series units may be combined with Branch Kits to create up to 36-ton systems
- 10-Year Parts and Compressor Warranty See Warranty Statement for details
- Extensive training available for for Engineers, Architects, Contractors and Distributors

High Efficiency & Reliability

Outdoor Units

J-Series



3, and 4 tons
Single-phase



3, 4 and 5 tons
Single-phase



6, 8 and 10 tons
Three-phase

V-Series



6, 8 Ton
Three-phase



10 Ton
Three-phase



12, 14, 16 Ton
Three-phase

A World Leader in Heating and Cooling Solutions

Support Team

Fujitsu features an expert team of Regional Sales Managers and Sales Engineers located around North America to provide customer support. Additionally, blended Rep Agencies support Plan and Spec Consulting Engineers, as well as wholesale distribution, to provide product knowledge and support. We pride ourselves in having one of the most educated and qualified teams in the HVAC industry.



Technical Support

The Fujitsu support experience is top notch! We have highly trained and field-experienced technicians on staff as well as strategically placed, Regional Support Specialists (RSS) to provide local support. The service team works closely with Quality, Product, and R&D team members in the US and overseas for new product innovation and improvement.

Service department enhancements include:

- Enhanced VIP call routing / lower wait times.
- Mobile Technician app: troubleshoot error codes, thermistors and pressure sensors
- 24-hour response on Servicehvac@fujitsugeneral.com
- Zendesk guide for technical information
- Zendesk chat

Research & Development

The Headquarters-R&D Center (Japan) is equipped with a wide range of testing equipment envisioning a variety of operating conditions. This includes a testing tower with a 197ft. (60m) height difference for testing systems for tall buildings. We provide high quality & reliable products that meet the customers' needs from all over the world through this advanced R&D Center and 6 factories based in China and Thailand.



R&D Center & Technology Research Buildings



North America Corporate HQ and Training Center
Fujitsu General America (Pine Brook, NJ, USA)



AIRSTAGE Innovation and Learning Center
(Addison, TX, USA)



AIRSTAGE Innovation and Learning Center West
(Martinez, CA, USA)



JAPAN Head Office, R&D Center and 60 m Height
Difference Testing Tower (Japan)

Overseas Manufacturing Companies



Fujitsu General (Shanghai) Co., Ltd. (China)



F.G.L.S. Electric Co., Ltd. (China)



Fujitsu General Central Air-conditioner (Wuxi)
Co., Ltd. (China)



FGA (Thailand) Co., Ltd. (Thailand)



Fujitsu General Air Conditioning R&D (Thailand)
Co., Ltd. (Thailand)



Fujitsu General (Thailand) Co., Ltd. (Thailand)
FACTORY-2



Fujitsu General (Thailand) Co., Ltd. (Thailand)



TCFG Compressor (Thailand) Co., Ltd. (Thailand)

OUR HISTORY

Innovating in the HVAC industry since 1971 with ductless and VRF products.
VRF Business since 2001.

OUR MISSION

Living together for our future

Through innovation and technology, we deliver a brighter future with the peace of mind to our customers and societies around the world.

FUJITSU GENERAL's VRF AIRSTAGE™ Series has been developed based on our long-term air-conditioning technology know-how and was first launched 22 years ago. We have offered a series of products for all types of residential and commercial applications to meet the various market needs.



AIRSTAGE™ V-II

460V 3-Phase
6 to 24 tons / Heat Pump
100% Inverter driven



AIRSTAGE VR-II

208/230V 3-Phase
6 to 24 tons / Heat Recovery
100% Inverter driven



AIRSTAGE V-II

208/230V 3-Phase
6 to 24 tons / Heat Pump
100% Inverter driven

AIRSTAGE™ History



S series
8 tons / Heat recovery
& Heat pump



8 tons / Heat recovery
6, 8 tons / Heat pump
& Cooling



V series
6 to 30 tons / Heat pump



AIRSTAGE VR-II

VR-II series
High efficiency and compact design model
6 to 24 tons / Heat Recovery



AIRSTAGE V-II

V-II series
High efficiency and compact design model
Extensive lineup from 6 to 24 tons
in 2 ton increments / Heat pump

Global

2001

2003

2006

2007

2009

2012

2013

History of Environmental Measures

Certification Acquisition of

ISO14001

- 1998 : Fujitsu General (Shanghai) Co.,Ltd.
- 1999 : Fujitsu General (Thailand) co.,Ltd.
- 2002 : FGA(Thailand) Co.,Ltd.
- 2006 : Fujitsu General Central Air-conditioner (Wuxi) co.,Ltd.

Green Initiatives
Fujitsu introduces inverter technology and the use of environmentally friendly R410A refrigerant.



RoHS Compliant

Restriction of Hazardous Substances is an EU directive intended to protect the environment by forcing manufacturers to use environmentally friendly materials in all consumer electronics.



AIRSTAGE J-III L

208/230V 3-Phase
 J-III L Series
 High efficiency, medium capacity model
 6, 8, 10 tons / Heat pump



AIRSTAGE VR-II

460V 3-Phase
 6 to 24 tons / Heat Recovery
 100% Inverter driven



AIRSTAGE J-IIS

208/230V 1-Phase
 J-IIS Series
 High efficiency, small capacity model
 3, 4 tons / Heat pump



AIRSTAGE J-II

208/230V 1-Phase
 J-II Series
 High efficiency, small capacity model
 3, 4 and 5 tons / Heat pump



AIRSTAGE VU-V

208/230V, 460V 3-Phase
 VU-V Series
 Unified model - Heat Pump / Heat Recovery
 6 to 36 tons



AIRSTAGE J-IV

208/230V 1-Phase
 J-IV series
 3, 4, 5 tons / Heat Pump
 Expanded heating operation range for cold climates, connect up to 15 indoor units



AIRSTAGE J-IVS

208/230V 1-Phase
 J-IVS series
 3, 4 tons / Heat Pump
 Expanded heating operation range for cold climates, connect up to 12 indoor units

Global Rebrand
AIRSTAGE

North America

2014

2015

2017

2019

2021

2022

2023

Green Advancement
 Use of 100% inverter driven
 DC compressors.

INVERTER

Light Commercial & Commercial, Residential VRF

AIRSTAGE™ VRF systems can be designed to create an air conditioning solution to suit most building requirements.

AIRSTAGE™ VRF systems can be designed to effectively provide an air conditioning solution from a large domestic residence to a large scale commercial building.

- p. 8 Features
- p. 22 VRF Outdoor Units Lineup

VRF Outdoor Units



AIRSTAGE™ J Series Heat Pump for Residential and Light Commercial Applications

- p. 24 AIRSTAGE™ J-IV
- p. 28 AIRSTAGE™ J-IVS
- p. 32 AIRSTAGE™ J-IIIIL



AIRSTAGE™ V Series Heat Pump/Heat Recovery for Light Commercial and Commercial Applications

- p. 36 AIRSTAGE™ VU-V

VRF INDOOR UNITS

- p. 46 VRF Indoor Units

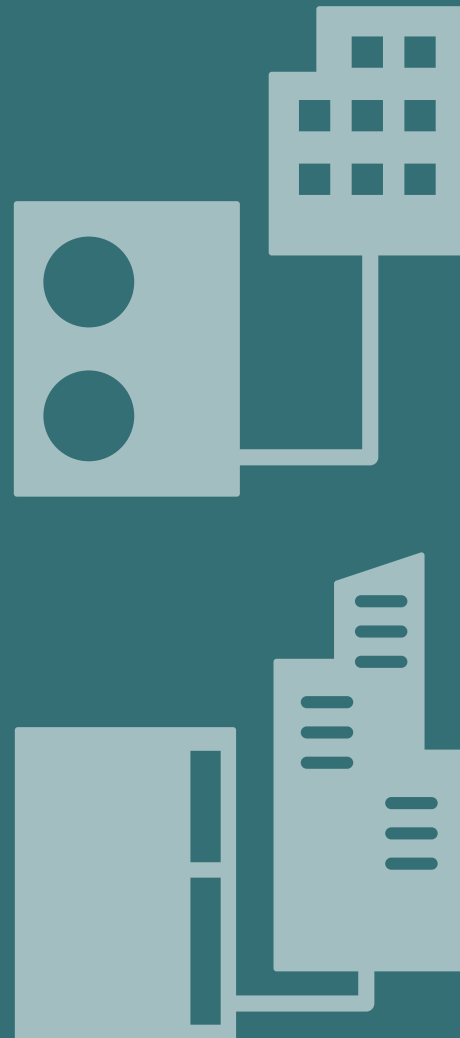

AIRSTAGE

V R F

Light Commercial &
Commercial,
Residential

Features

High Efficiency

High system efficiency is achieved by using DC twin rotary compressor, scroll compressor, inverter technology, and large efficient heat exchanger.



DC twin rotary compressor

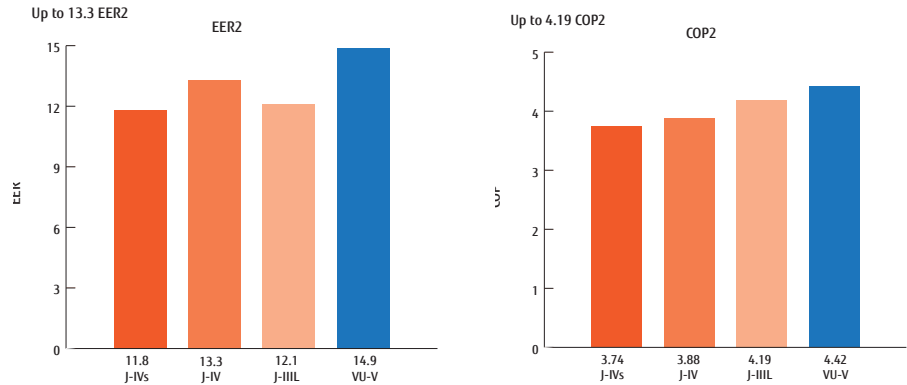

ALL DC High efficiency design with great SEER2, IEER and COP2 values

All VRF Series including J-III L Series utilize inverter technology to achieve high efficiency operation. This technology improves both the durability and reliability of the systems.

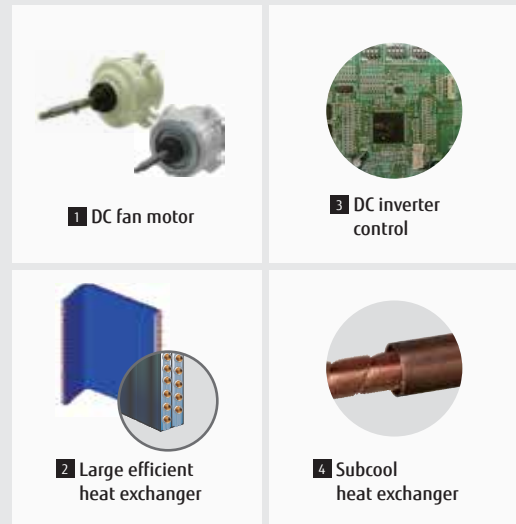

VU-V-Series 12, 14, and 16 Ton

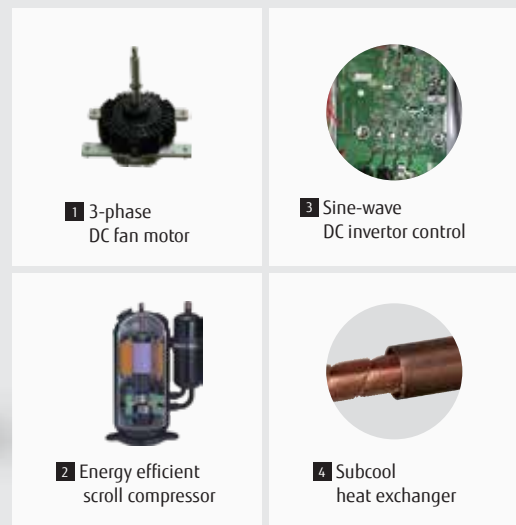

Operation Performance is Efficiently Controlled



Room temperature set point limitation

The minimum and maximum temperature set point ranges can be limited, which can provide further energy saving while maintaining the comfort of the occupants.

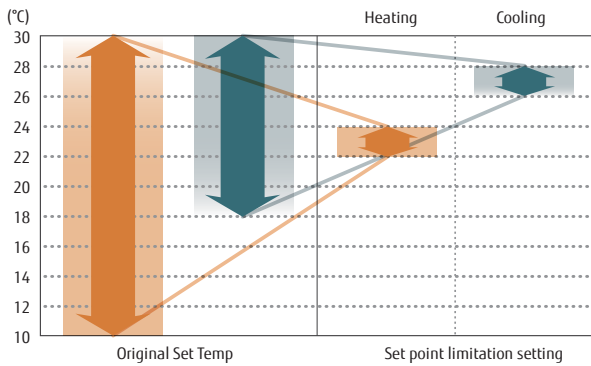

Auto-off timer

The wired remote controller is equipped with an OFF timer function that automatically stops operation when a fixed time has elapsed from the start of operation. This can increase the energy efficiency. Furthermore the wired RVRU or RNRUZ* remote controller can set up the interval of time in case operation stops.

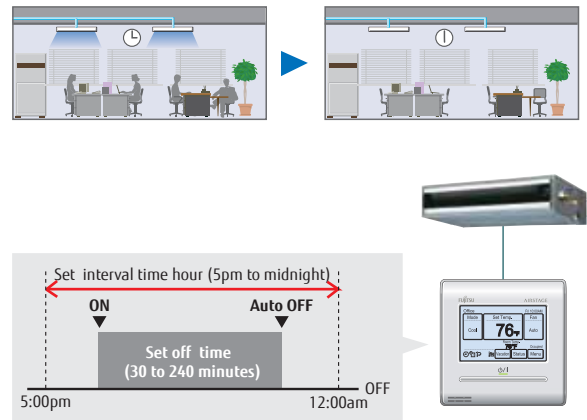

Energy saving management

The system controller can be used to set a variety of different energy saving operations, depending on the season, weather, and occupant schedules.

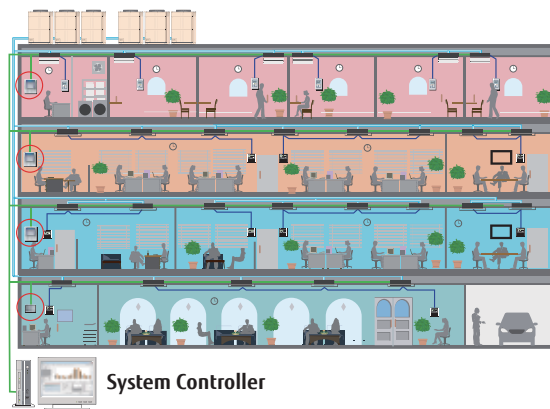

Capacity saving operation

Operation capacity can be adjusted based on capability and lowered power usage. The outdoor units can be set for capacity limiting through a BACnet gateway.

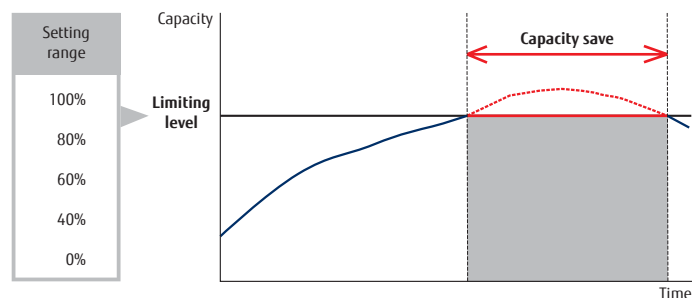



Intelligent refrigerant control

Fujitsu intelligent refrigerant control optimizes the comfort in each individual zone while providing reliable and energy-efficient system operation.

The intelligent refrigerant control minimizes starting and stopping of the compressors while keeping the target zone temperatures. The control also maximizes energy efficiency by running the compressors longer times but at an optimized speed.

Outdoor unit with improved refrigerant control

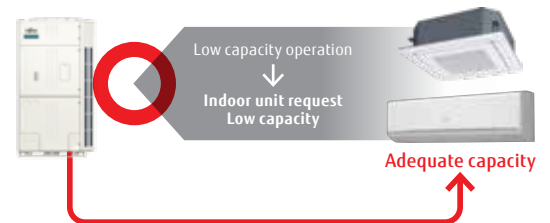

Outdoor unit supplies adequate capacity based on demand from indoor unit

* The improvement by the control and the actual sine wave varies by the combination of the indoor unit and system operating condition.

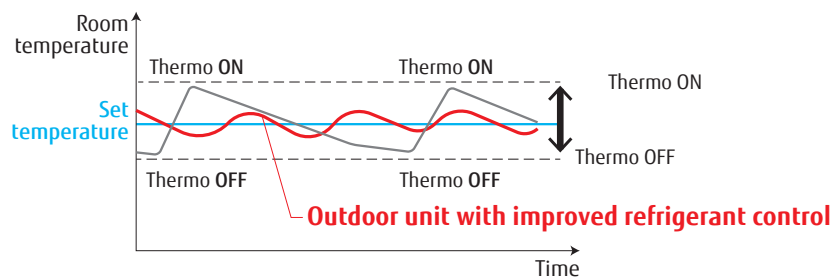

More Comfort



Auto changeover function

In Auto setting mode in a Heat Recovery system, the cooling/heating mode is automatically switched in each room according to the set temperature and actual room temperature.

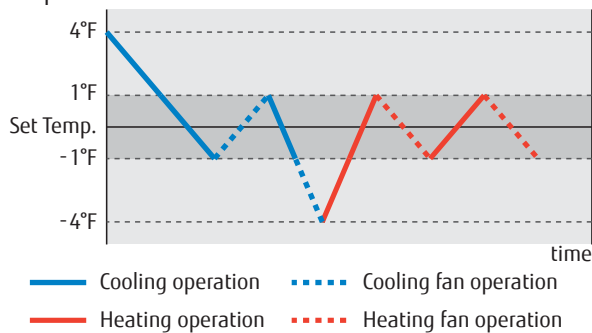

Auto changeover setting allows for each indoor unit to easily switch between cooling and heating regardless of the operation mode of other indoor units. This ensures optimized comfort all year round.

Automatic cooling/heating operation mode for each room is possible

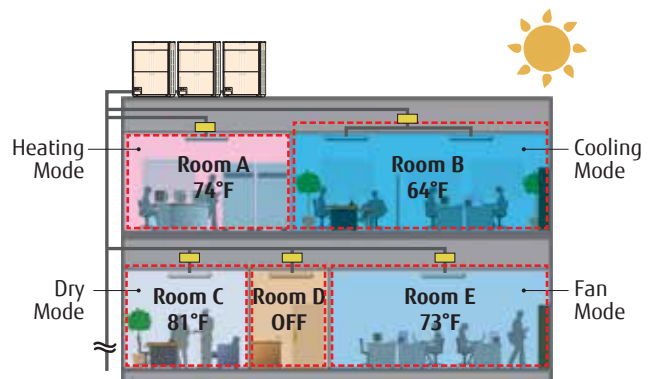

Precision refrigerant flow control

Precise and smooth refrigerant flow control is achieved by using DC Inverter control in conjunction with individual indoor unit electronic expansion valve control. This allows high precision comfortable temperature control of $\pm 1^\circ\text{F}$.

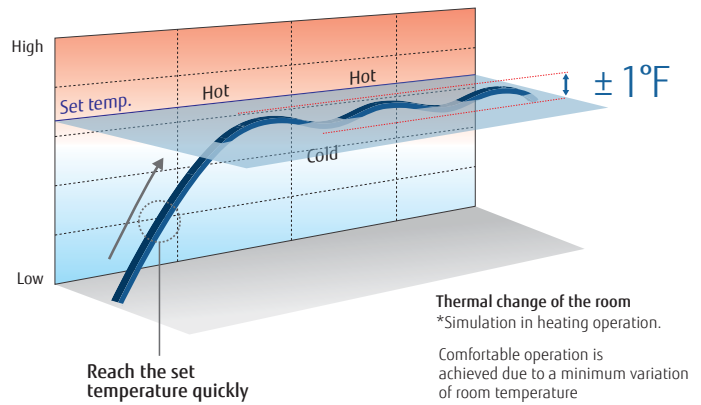

Quiet operation



Quiet operation

Two low noise modes can be selected automatically by quiet priority setting and capacity priority setting depending on the indoor environment and outside temperature load. This feature can be controlled via outdoor unit external input and/or system controller.

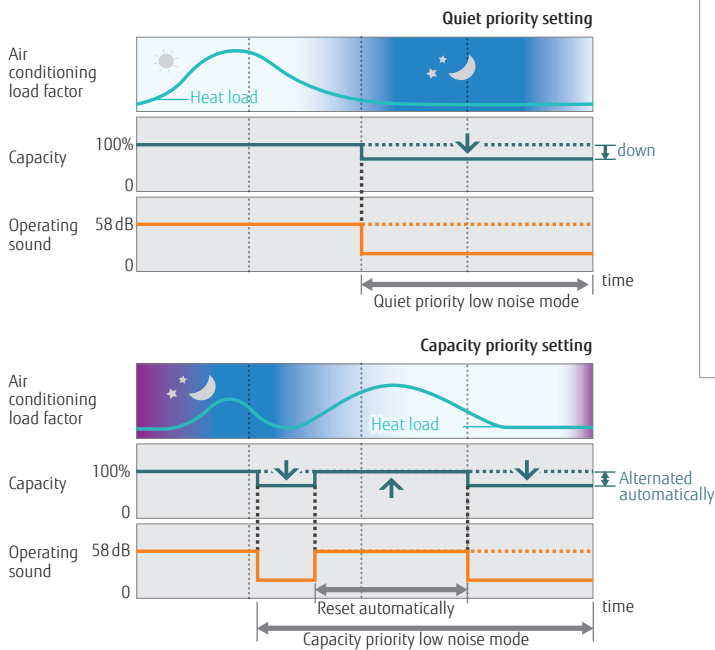

Non-stop oil recovery operation

The system continues to operate and maintain a comfortable room condition even during the brief oil recovery mode operation.

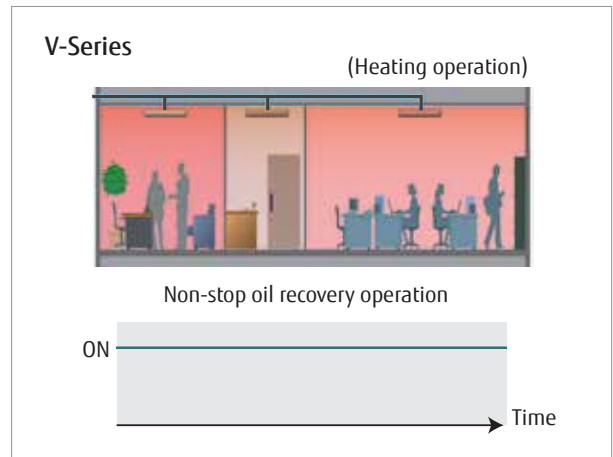

Low sound level design

All the indoor units in the AIRSTAGE system have a low sound level design. In low capacity operation the sound level can be as slow as 21dB(A).



High Reliability

Outdoor unit rotation

* Continuation contents from the traditional model

The compressor starting order is rotated to equalize the cumulative running time of each unit.

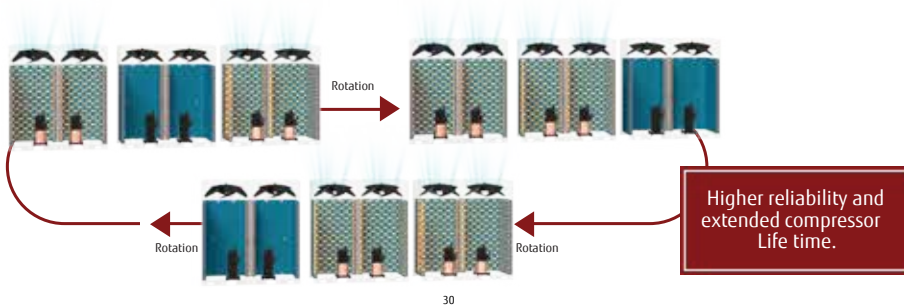

30

Advanced refrigerant control

* Continuation contents from the traditional model

Compressor control logic controls the inverter speed to balance the mass airflow rate of refrigerant in each outdoor unit.

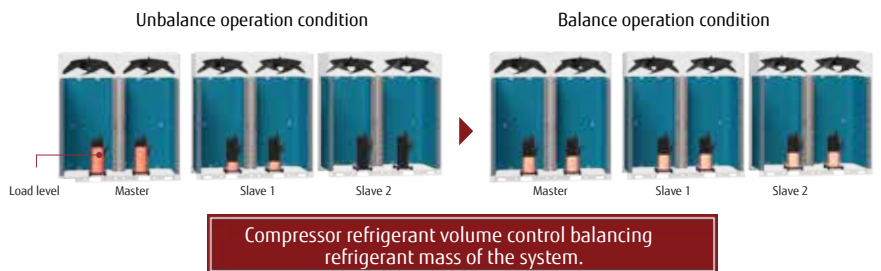

Protection against liquid flowback

* Continuation contents from the traditional model

The use of a large accumulator means that refrigerant that has not been completely vaporized stays inside the accumulator to ensure no liquid refrigerant is fed into the compressor.

Large sized accumulator for reliable compressor operation.

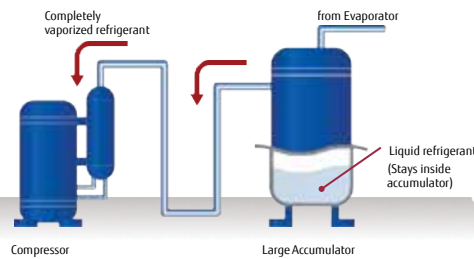

Blue fin heat exchanger

Blue fin coating of the outdoor unit heat exchanger ensures corrosion protection for harsh environments.

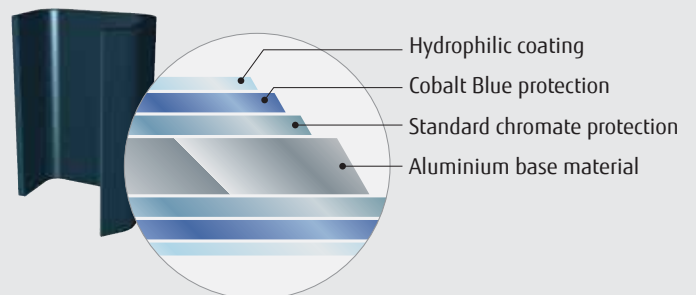

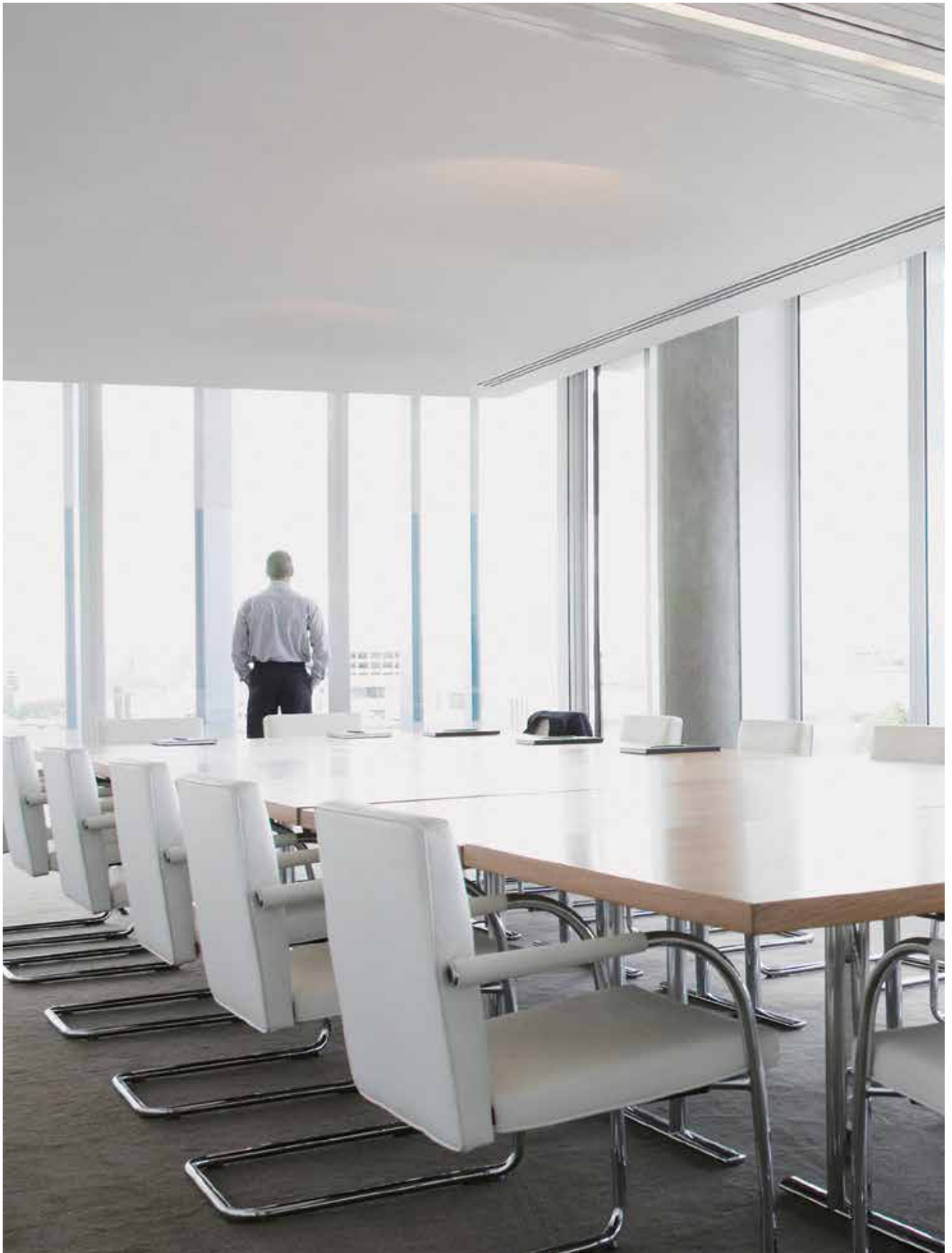

Design Flexibility



Efficient and compact design

Compact outdoor unit and optimized air flow pattern.



AIRSTAGE™ J-Series Compact Outdoor Unit



Flexible piping design





Generous piping guidelines to enable the system to be used in a variety of applications.

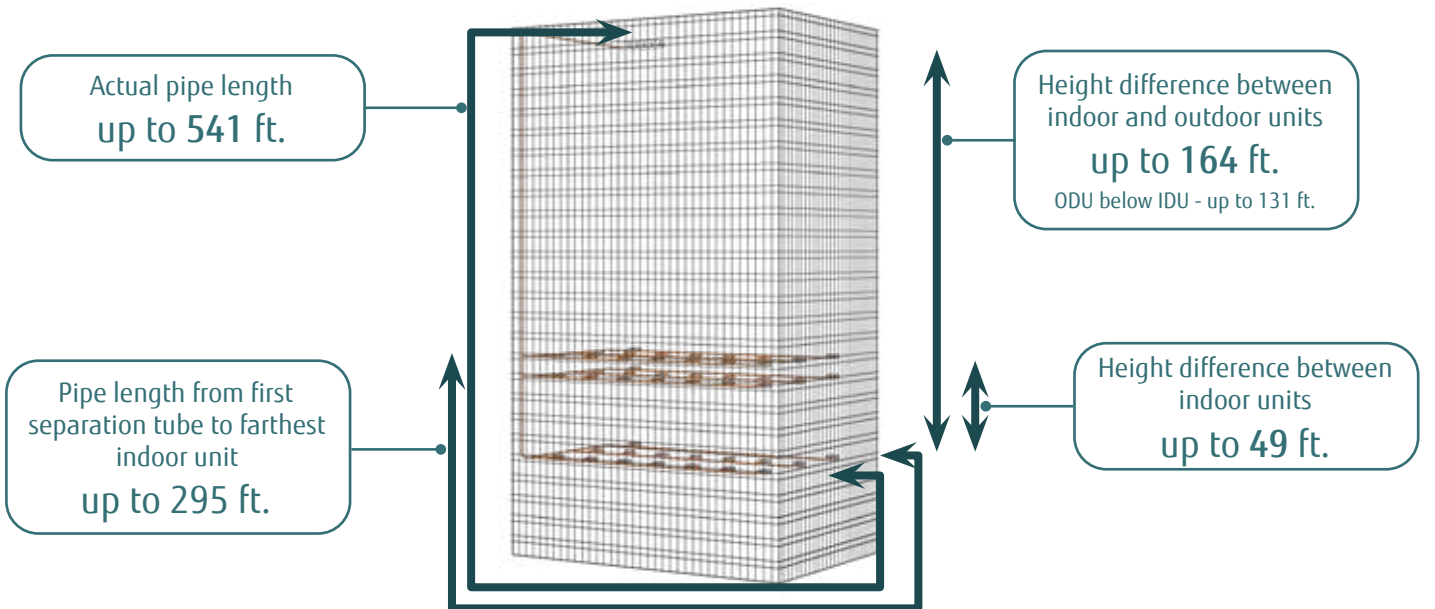
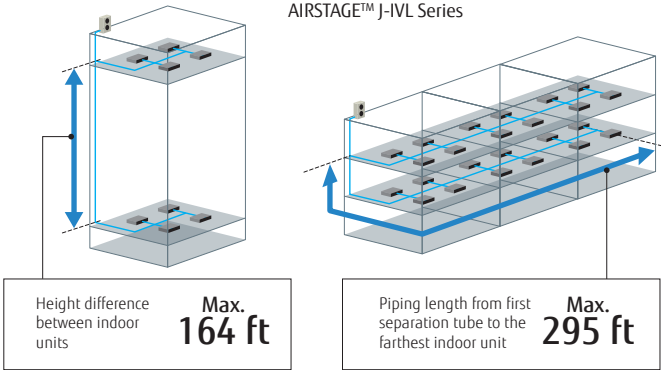

AIRSTAGE™ J-IVL Series



High capacity connection

Series	Connectable indoor unit total capacity range	Connectable indoor unit quantity
 J-IVs	50% to 130%	up to 12
 J-IV	50% to 150%	up to 15
 J-IIIIL	50% to 150%	up to 30
 VU-V	25% to 150% (select models)	up to 64



Designed for low refrigerant charge

Optimal design of indoor unit and outdoor unit reduces the refrigerant volume in a system to enable installation in small spaces while adhering to local codes.



Optional parts

- Integrated outside air intake capabilities with optional air intake kits for most of the indoor units.
- Comfortable room temperature with advanced controls and remote sensor options.
- DX-Kit that enables seamless integration of non-VRF air handling units into the VRF system.

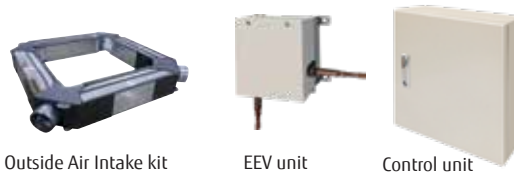

Outside Air Intake kit

EEV unit

Control unit



Low ambient operation

Improved refrigeration technology allows system operation in colder climates.



Extended operating range

Extended operation range enables heating and cooling in colder climates.

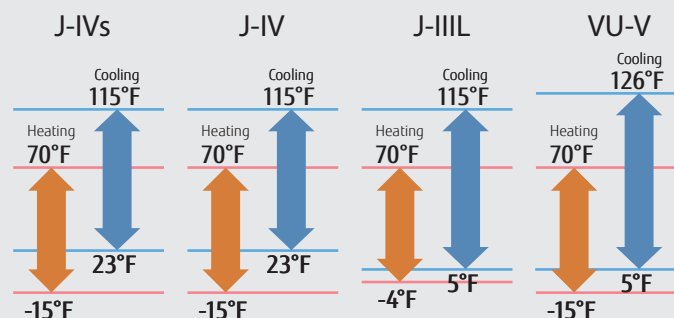

Easy Installation



Easy to transport

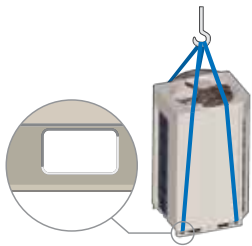

Easy to lift with a crane

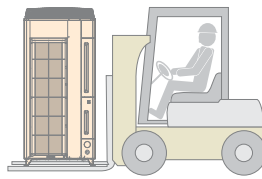

Easy to move with a forklift



Can fit in a standard elevator

Easy access

The L-Shape front panel, that easily can be removed, increases the space for installation and service.

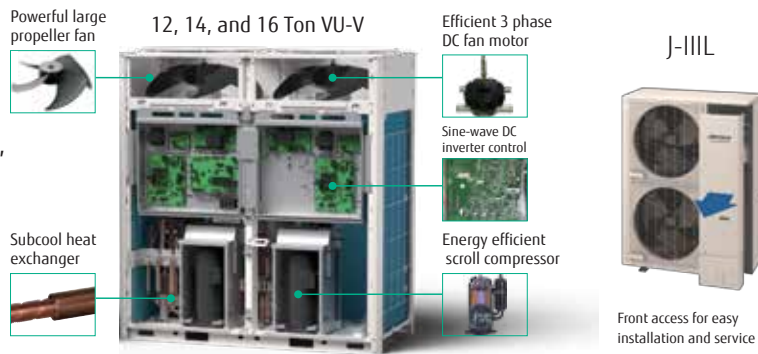

Flexible piping connection

Piping and wiring are available through the front, left, right and bottom.

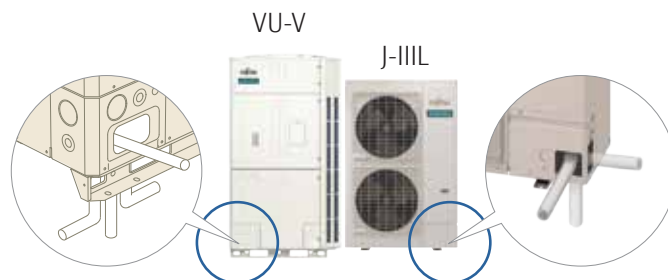



Simple wiring work

Installation of the wiring systems is made easier as the communication wiring can be installed continuously between the indoor, outdoor and RB units.

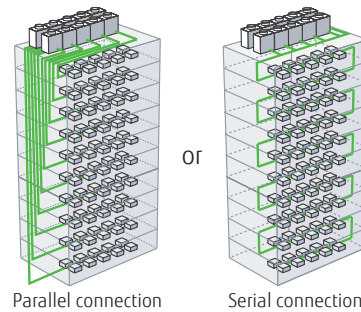

Up to maximum length
11,811 ft

Easy evacuation - using vacuum mode function

The vacuum mode function enables all expansion valves of indoor units to be fully opened, making the evacuation of the refrigerant circuit easy after installation.

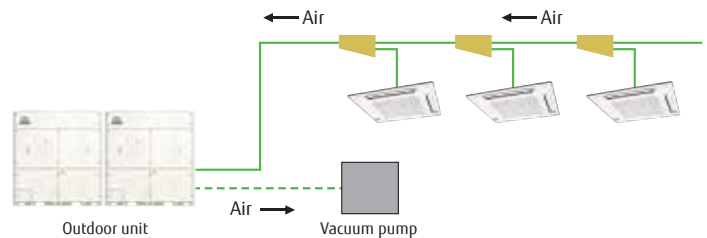

Automatic address setting

Address setting of the indoor unit, RB unit and signal amplifier through the automatic function setting on the outdoor unit PCB.

Automatic address setting is performed at outdoor unit

Addresses are automatically distributed from outdoor unit.



Press the push button of outdoor unit.

Manual address setting from indoor unit and remote controller is also possible.

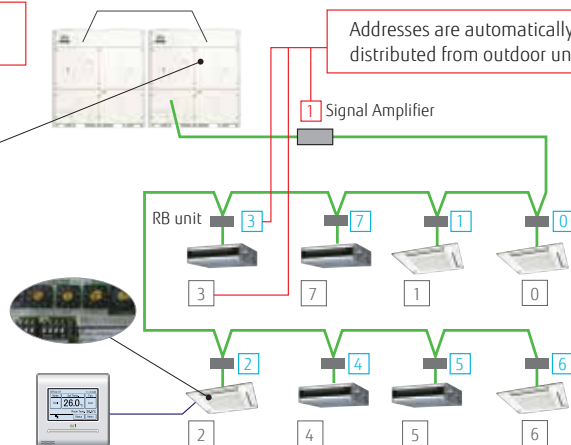

Easy diagnosing with Service Tool

User friendly Service Tool that can show system conditions such as refrigerant temperatures and pressures, electronic expansion valve position, etc., makes it easy to verify proper system operation.



Easy Service & Maintenance

Designed for Easy Maintenance

7 segment LED displays makes it easy to verify operation details such as function setting status, refrigerant temperature, pressure, compressor operation time, etc.

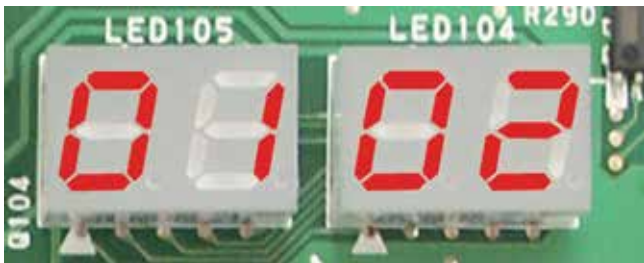

Easy to read 7-segment LED

Operating status for Outdoor Unit can easily be checked on the display:

- Operation mode status
- Discharge temperature/Pressure status
- Compressor operation indication
- Address/type/number of outdoor unit

Service and maintenance window

Service window provides ease of access to multi-functional display and buttons without removing any main front panels.



Removable PCB panel
Enables easy
maintenance access



Operating status can be checked easily via the indoor unit wired controller

An operation code is displayed on a liquid crystal screen.

Kagami Wired Remote Controller

Wired Remote Controller (Touch Panel)

Simple Remote Controller



Operation status / Operation history

No.	Date	Time	Address	Code
1	2017/7/20	11:00AM	000-401	181
2	2017/7/20	2:53AM	000-402	183
3	2017/7/20	8:30AM	000-402	182
4	2017/7/20	11:00AM	000-401	181
5	2017/7/20	11:00AM	000-401	181
6	2017/7/21	11:00AM	000-401	181



Remote controller address

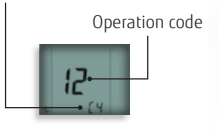

Operation diagnosis by Service Tool

Connection to Service Tool



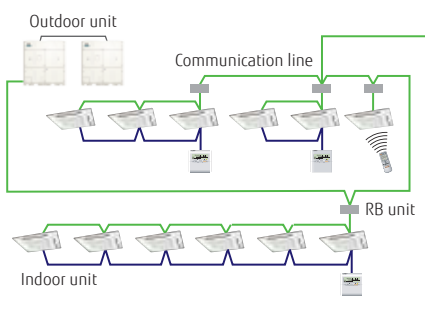





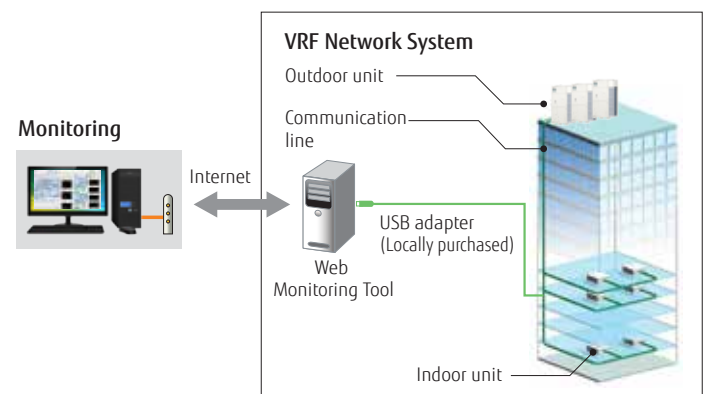







































- Detailed operation status and recent operation history can be checked and analyzed by using the Service Tool.
- Operation status of the last 5 minutes stored in memory.











Remote monitoring

The Web Monitoring system allows you to view system operation anytime over the internet, ensuring issue free operation.



		1-PHASE / 208-230V		1-PHASE / 208-230V		1-PHASE / 208-230V		1-PHASE / 208-230V			
		JIV-S		J-IV		J-IV		J-IV			
OUTDOOR UNITS LINEUP	J-SERIES	 AOU36RLAVS4	 AOU48RLAVS4	 AOU36RLAVM4	 AOU48RLAVM4	 AOU60RLAVM4	3-PHASE POWER SOURCE: *B = 208-230V, *C=460V				
	VU-V HEAT PUMP / HEAT RECOVERY	72,000 BTU/h (6-tons)	 AOUA72ULBV5 AOUA72ULCV5	96,000 BTU/h (8-tons)	 AOUA96ULBV5 AOUA96ULCV5	120,000 BTU/h (10-tons)	 AOUA120ULBV5 AOUA120ULCV5	144,000 BTU/h (12-tons)	 AOUA144ULBV5 AOUA144ULCV5	168,000 BTU/h (14-tons)	 AOUA168ULBV5 AOUA168ULCV5
		264,000 BTU/h (22-tons)	 AOUA264ULBVG5 AOUA264ULCVG5	288,000 BTU/h (24-tons)	 AOUA288ULBVG5 AOUA288ULCVG5	312,000 BTU/h (26-tons)	 AOUA312ULBVG5 AOUA312ULCVG5	336,000 BTU/h (28-tons)	 AOUA336ULBVG5 AOUA336ULCVG5	360,000 BTU/h (30-tons)	 AOUA360ULBVG5 AOUA360ULCVG5
INDOOR UNITS LINEUP	Capacity range (BTU/h)	4,000	7,000	9,000	12,000	14,000	18,000				
	Compact Cassette ¹	 AUUA4TLAV2	 AUUA7TLAV2	 AUUA9TLAV2	 AUUA12TLAV2	 AUUA14TLAV2	 AUUA18TLAV2				
	Large Circular Flow Cassette ²				 AUUB12TLAV2	 AUUB14TLAV2	 AUUB18TLAV2				
	Mini-Duct	 ARUL4TLAV2									
	Slim Compact Duct			 ARUL7TLAV2	 ARUL9TLAV2	 ARUL12TLAV2	 ARUL14TLAV2	 ARUL18TLAV2			
	Medium Static Pressure Duct										
	High Static Pressure Duct										
	Multi-Position Air Handling Unit							 ARUX12TLAV2	 ARUX18TLAV2		
	Floor Mount	 AGUA4TLAV2	 AGUA7TLAV2	 AGUA9TLAV2	 AGUA12TLAV2	 AGUA14TLAV2					
	Floor/Ceiling							 ABUA12TLAV2	 ABUA14TLAV2	 ABUA18TLAV2	
	Ceiling										
	Compact Wall Mount	 ASUA4TLAV2	 ASUA7TLVA2	 ASUA9TLAV2	 ASUA12TLVA2	 ASUA14TLAV2					
	Wall Mounted							 ASUB18TLAV2			
Outdoor Air Unit											
Airflow Rate CFM (m3/h)			636 (1,080)	989 (1,680)	1,236 (2,100)						
Outdoor Air Unit			 AAUA48TLAV ³	 AAUA72TLAV ⁴	 AAUA96TLAV ⁴						

3-PHASE / 208-230V		J-IIIIL		
J-SERIES	6-ton  AOU72RLAVL	8-ton  AOU96RLAVL	10-ton  AOU120RLAVL	
VU-V HEAT PUMP / HEAT RECOVERY	192,000 BTU/h (16-tons)  AOUA192ULBG5 AOUA192ULCV5	216,000 BTU/h (18-tons)  AOUA216ULBG5 AOUA216ULCV5	240,000 BTU/h (20-tons)  AOUA240ULBG5 AOUA240ULCV5	
	384,000 BTU/h (32-tons)  AOUA384ULBG5 AOUA384ULCV5	408,000 BTU/h (34-tons)  AOUA408ULBG5 AOUA408ULCV5	432,000 BTU/h (36-tons)  AOUA432ULBG5 AOUA432ULCV5	

	24,000	30,000	36,000	48,000	60,000	72,000	96,000
 AUUA24TLAV2							
 AUUB24TLAV2		 AUUB30TLAV2	 AUUB36TLAV2	 AUUB48TLAV2			
 ARUM24TLAV2	 ARUMTLAV2	 ARUM36TLAV2	 ARUH36TLAV2	 ARUH48TLAV2	 ARUH60TLAV2	 ARUH72TLAV2	 ARUH96TLAV2
 ARUX24TLAV2	 ARUX30TLAV2	 ARUX36TLAV2	 ARUX48TLAV2	 ARUX60TLAV2			
 ABUA24TLAV2	 ABUA30TLAV2	 ABUA36TLAV2					
 ASUB24TLAV2	 ASUA30TLAV2	 ASUA36TLAV2					

1. Compact Cassette Grille UTG-CCGVG sold separately. Must order one with each Compact Cassette.
2. Cassette Grille UTG-LCGVCW (White) or UTG-LCGVCB (Black) sold separately. Must order one with each Cassette.
3. J-Series compatibility is dependent on outdoor unit capacity.

Heat Pump

Single phase 208/230V
3, 4 Ton

AIRSTAGE J-IVS

System configuration example

- This system is used for small and medium-sized buildings.
- Connection of multiple indoor units using separation tubes and headers.
- Up to 12 indoor units to one outdoor unit.

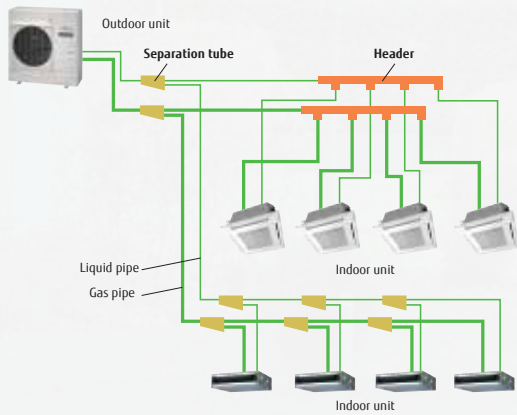

Expanded Heating Operation Range

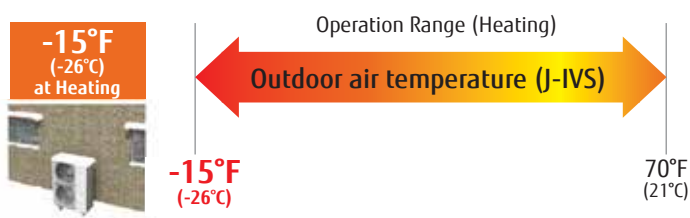

Optimized Breaker Size

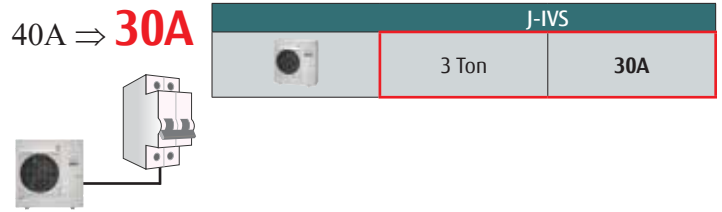

Intelligent refrigerant control

The intelligent refrigerant control provides improved comfort for people and energy-efficient operation.

External static pressure

Increased installation flexibility with available external static pressure up to 0.10 in WG.



Advanced high efficiency technology

Large and efficient propeller fan

Efficient high performance fan with low sound level.



DC fan motor

Low sound level, high efficiency multi-stage DC fan motor.



Large efficient heat exchanger

High efficiency 3-row heat exchanger.

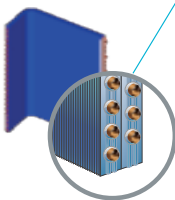

Smooth airflow grille

Exhaust grille designed with minimum pressure loss.

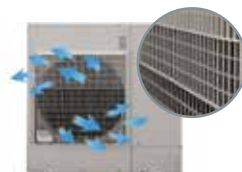

Efficient DC Inverter control

Improved efficiency with active filter module

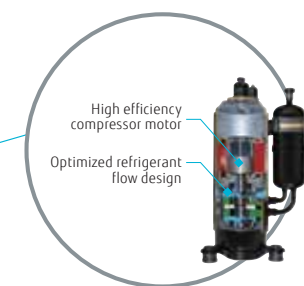

Compact and high performance DC twin rotary compressor

DC twin rotary compressor for high efficiency in all load situations

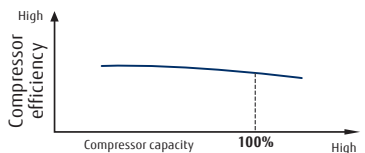

Built-in Basepan Heater



Easy to install

Low weight and small space requirements.

Low sound level design

Low sound levels due to inverter DC twin rotary compressor and advanced air flow technology.

Flexible piping

Fujitsu advanced refrigerant control technology allows a total refrigerant piping length of 262 ft.

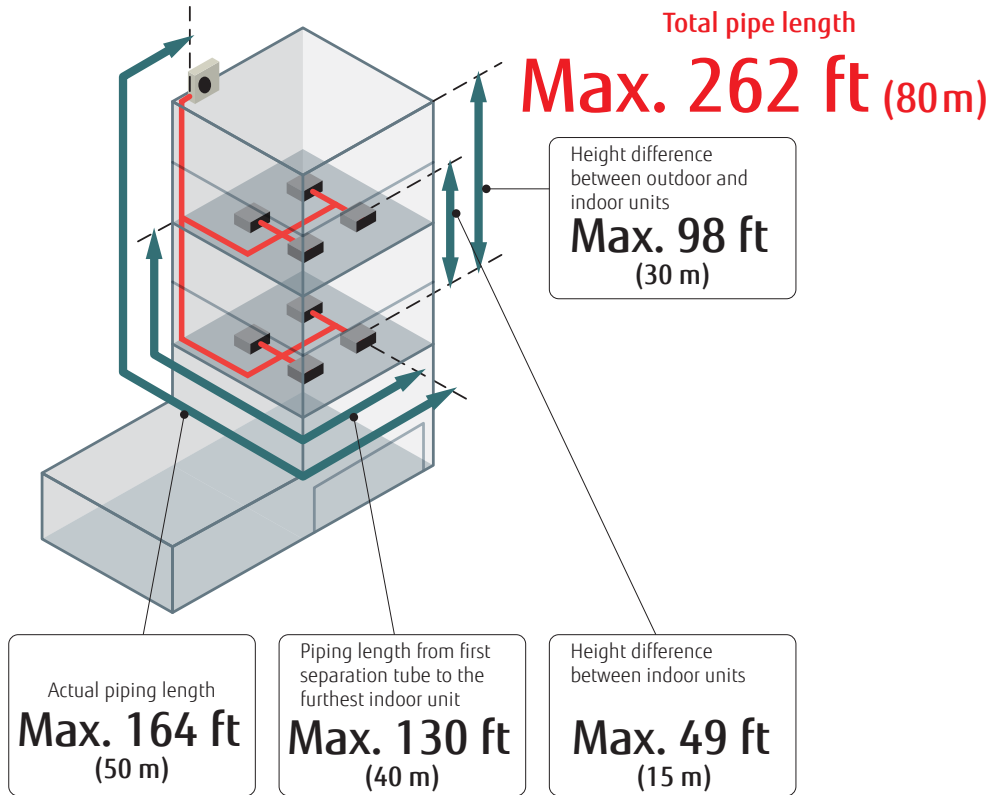

Non-stop oil recovery operation

Room comfort is kept with continuous heating and cooling even during the brief oil return operation.

Small and light weight outdoor unit

Very compact and light weight design. Can be installed on balcony, patio or below windows.

J-IVS Series

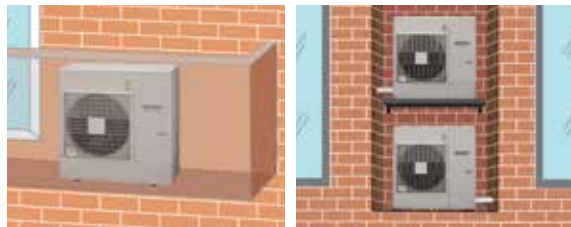

Non-stop oil recovery operation

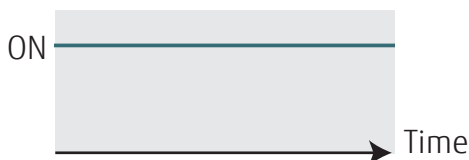

Up to 12 Indoor Units can be connected to one system

Model	J-IVS	
Nominal System Capacity (tons)	3	4
Connectable indoor units	1-9	1-12

AOU36RLAVS4, AOU48RLAVS4



Specifications

Nominal System Capacity		Ton(s)	3	4
Model Name			AOU36RLAVS4	AOU48RLAVS4
Indoor unit connectable capacity ratio			50% to 130%	
Maximum Connectable Indoor Units			1-9	1-12
Power source			208 / 230 VAC, 1-Phase, 60Hz	
Cooling capacity (Non-Ducted/Ducted)	Capacity	Btu/h	36,000	48,000
	EER EER2	Btu/h/W	11.8 / 11.2 11.80 / 10.25	9.6 / 9.1 9.60 / 8.40
	SEER SEER2	-	19.7 / 17.4 20.5 / 15.5	18.8 / 16.9 20.4 / 14.7
Heating capacity (Non-Ducted/Ducted)	Capacity	Btu/h	42,000	54,000
	COP COP2	W/W	3.74 / 3.56 3.74 / 2.80	3.54 / 3.36 3.54 / 3.08
	HSPF HSPF2	-	11.20 / 10.30 9.7 / 7.9	10.90 / 10.10 9.4 / 8.2
Airflow rate	"Cooling *Heating(J-IV only)"	CFM (m3/h)	2,378 (4,040)	2,472 (4,200)
Sound pressure level	Cooling / Heating	db(A)	52 / 54	53 / 55
Dimensions	HxDxW	in. (mm)	39-5/16 x 38-3/16 x 14-9/16 (998 x 970 x 370)	
Weight		lbs.(kg)	196 (89)	
Connection pipe diameter	Liquid	in. (mm)	3/8 (9.52)	
	Gas		5/8 (15.88)	
Max.total pipe length		ft. (m)	262 (80)	
Max.actual pipe length (OU to furthest IU)			164 (50)	
Max.height difference (OU:Upper / Lower)			98 (30) / 98 (30)	
Operation range	Cooling	°F (°C)	23 - 115 (-5 - 46)	
	Heating	°F (°C)	-15 - 70 (-26 - 21)	
Refrigerant type			R410A	
Maximum Circuit Breaker		A	30	40
Minimum Circuit Ampacity (MCA)		A	29.7	33.4

Dimensions

(Units: in (mm))

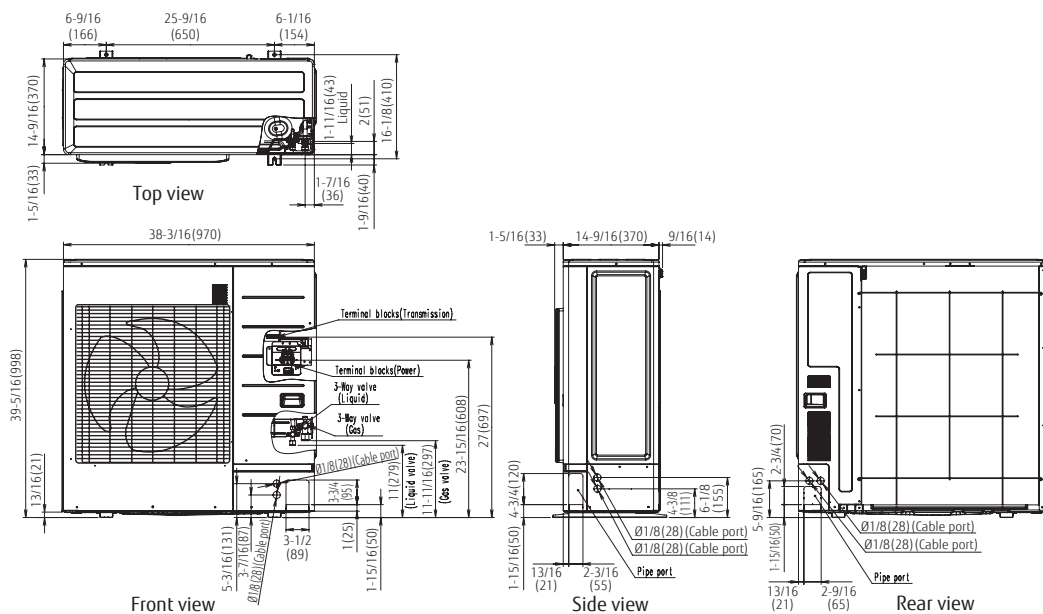

Heat Pump

Single phase 208/230V

3, 4 and 5 Ton

AIRSTAGE J-IV

System configuration example

- This system is used for small and medium-sized buildings.
- Connection of up to 15 indoor units to one outdoor unit.

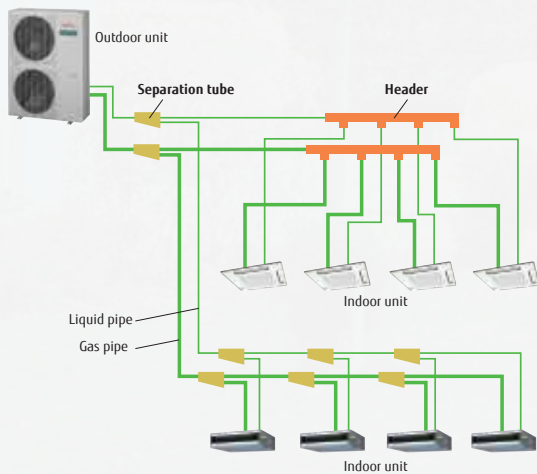

Expanded Heating Operation Range

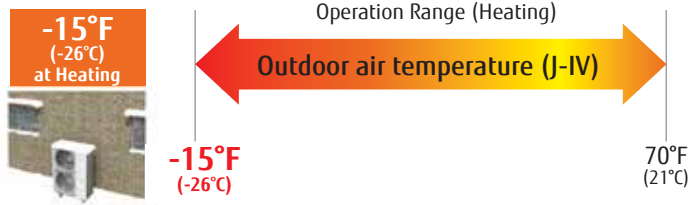

Optimized breaker size

40A ⇒ **30A**

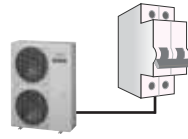

		J-IV	
	3 Ton	30A	
	4 Ton	30A	

Intelligent refrigerant control

The intelligent refrigerant control provides improved comfort for people and energy-efficient operation.

External static pressure

Increased installation flexibility with available external static pressure up to 0.12 in WG.



Advanced high efficiency technology

- Large and efficient propeller fan**
Efficient high performance fan with low sound level.
- DC fan motor**
Low sound level, high efficiency multi-stage DC fan motor.
- Large efficient heat exchanger**
High efficiency 3-row heat exchanger.
- Efficient DC Inverter control**
Improved efficiency with active filter module
- Subcooling heat exchanger**
Efficient cooling performance with dual tube heat exchanger
- DC twin rotary compressor**
DC twin rotary compressor for high efficiency in all load situations
- High efficiency compressor motor**
- Optimized refrigerant flow design**

Pressure-Enthalpy Diagram: Shows a refrigerant cycle with 'effect' and 'Cooling performance improved' indicated.

Compressor Efficiency Diagram: Shows 'High compressor efficiency' vs 'Compressor capacity High' for the 'DC Twin Rotary compressor'.

Flexible piping

Fujitsu advanced refrigerant control technology allows a total refrigerant piping length of 590 ft.

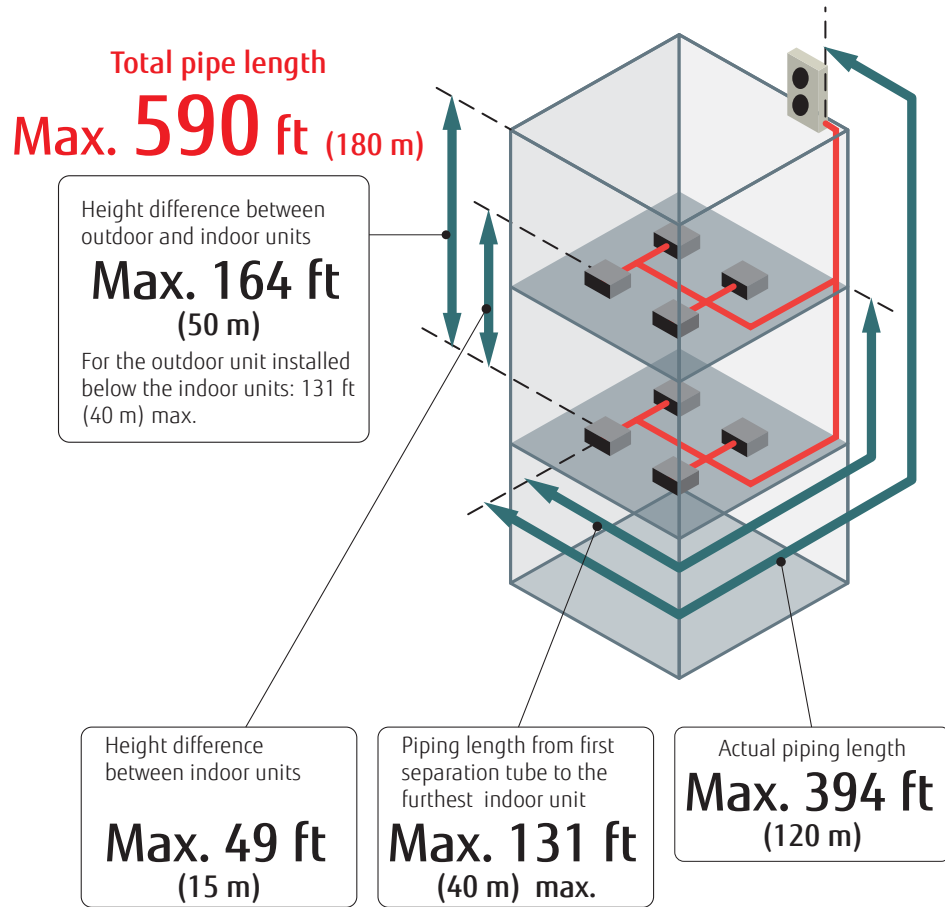

Continous heating and cooling during oil return operation

Room comfort is kept with continuous heating and cooling even during the brief oil return operation.

J-IV Series



Non-stop oil recovery operation



Up to 15 indoor units can be connected in one system

Model	J-IV		
	Nominal System Capacity (tons)	3	4
Number of connectable indoor units	1-9	1-12	1-15

AOU36RLAVM4, AOU48RLAVM4, AOU60RLAVM4



Specifications

Nominal System Capacity		Ton(s)	3	4	5
Model Name			AOU36RLAVM4	AOU48RLAVM4	AOU60RLAVM4
Indoor unit connectable capacity ratio			50% to 150%		
Maximum Connectable Indoor Units			1-9	1-12	1-15
Power source			208 / 230 VAC, 1-Phase, 60Hz		
Cooling capacity	Capacity	Btu/h	36,000	48,000	60,000
(Non-Ducted/Ducted)	EER EER2	Btu/h/W	13.3 / 12.5 13.3 / 10.6	12.5 / 11.8 12.5 / 9.6	10.8 / 10.4 10.8 / 9.1
	SEER SEER2	-	19.0 / 17.0 19.2 / 15.5	19.8 / 18.1 20.4 / 15.6	18.5 / 16.5 19.5 / 14.7
Heating capacity	Capacity	Btu/h	42,000	54,000	66,000
(Non-Ducted/Ducted)	COP COP2	W/W	3.82 / 3.86 3.82 / 2.82	3.88 / 3.64 3.88 / 3.60	3.64 / 3.60 3.64 / 3.30
	HSPF HSPF2	-	11.50 / 10.00 10.0 / 8.2	11.10 / 10.40 9.60 / 8.5	11.00 / 10.50 9.41 / 8.6
Airflow rate	"Cooling *Heating (J-IV only)"	CFM (m3/h)	3,649 (6,200) *3,649 (6,200)	3,767 (6,400) *3,767 (6,400)	4,827 (8,200) *4,002 (6,800)
Sound pressure level	Cooling / Heating	db(A)	50 / 52	51 / 53	57 / 57
Dimensions	HxDxW	in. (mm)	52-1/2 × 38-3/16 × 14-9/16 (1,334 × 970 × 370)		
Weight		lbs. (kg)	262 (119)	265 (120)	271 (123)
Connection pipe diameter	Liquid	in. (mm)	3/8 (9.52)		
	Gas		5/8 (15.88)		3/4 (19.05)
Max.total pipe length		ft. (m)	590 (180)		
Max.actual pipe length (OU to furthest IU)			394 (120)		
Max.height difference (OU:Upper / Lower)			164 (50) / 131 (40)		
Operation range	Cooling	°F (°C)	23 - 115 (-5 - 46)		
	Heating	°F (°C)	-15 - 70 (-26 - 21)		
Refrigerant type			R410A		
Maximum Circuit Breaker		A	30		40
Minimum Circuit Ampacity (MCA)		A	29.8		37.7

Dimensions

(Units: in (mm))

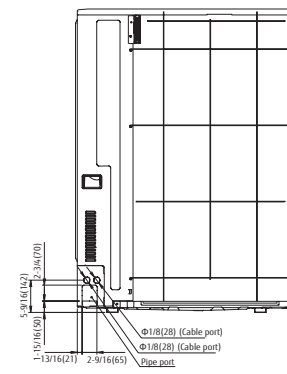
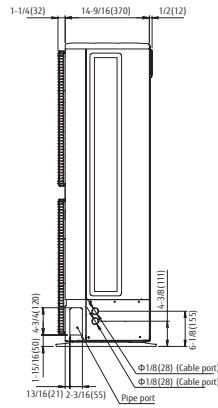
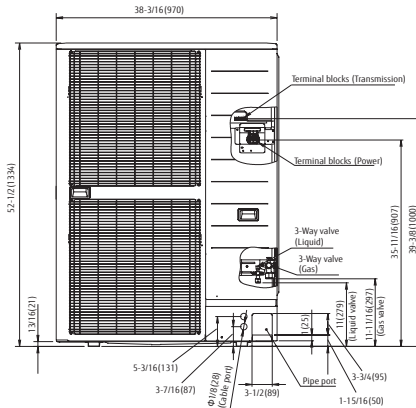
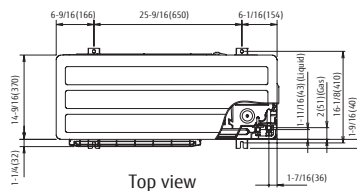

Heat Pump

3 Phase, 208-230V
6, 8, 10 Ton

AIRSTAGE J-III

The industry-leading AIRSTAGE J-III system is perfect for multi-family, large residential, light commercial and commercial buildings. The unique and compact design makes the outdoor unit ideal for buildings with limited installation space. Up to 30 indoor units can be connected to one outdoor unit.



Slim & Compact Design

The compact and slim design of the J-III series makes it ideal for buildings with limited installation space.



Interior Installation



Quiet operation does not disturb residents

Low sound level operation enables installation in any environment.

Installation in Alleys



AIRSTAGE™ J-Series outdoor unit



AIRSTAGE™ V-Series outdoor unit

Space saving

Space-saving design to fit in tight areas on the ground, on patios/balconies or on the wall.

Curbside Installation



AIRSTAGE™ J-Series outdoor units



Traditional VRF top-discharge outdoor units

Flexible installation

Slim and compact design enable outdoor units to be installed beneath windows

Flexible system configuration

Up to 30 indoor units can be connected to one outdoor unit

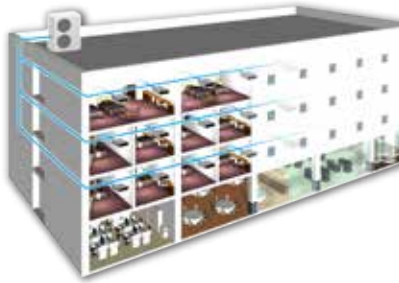

J-III L
Max. Connectable
Indoor Units
10Ton : 30units
8Ton : 24units
6Ton : 18units

Low sound level design

Low sound levels due to inverter DC twin rotary compressor and advanced air flow technology.

Sound levels
as low as
54 dB(A)



J-III L

High Static Pressure

Increased installation flexibility with available external static pressure up to 0.24in. W.G (60Pa).

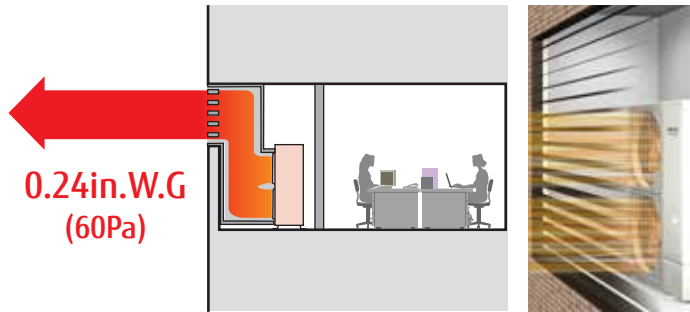

Indoor unit and controller connectivity



Wall Mounted

Mini Duct

Compact Cassette

Compact Floor

JIII-L outdoor units can connect to:

- 14 types of indoor units - 58 different models (Capacity ranges from 4,000 to 96,000 BTU/h)
- Wide range of control options



Installation Flexibility

Flexible Piping

Fujitsu advanced refrigerant control technology allows a total refrigerant piping length of 1312 ft.

Total Piping Length
Max. 1,312 ft.
(400m)

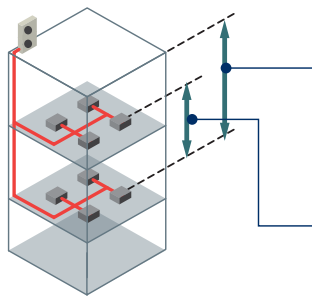

Height difference between outdoor and indoor units

Max. 164ft. (50m)

For the outdoor unit installed below the indoor units: 131ft. (40m) max.

Height difference between indoor units

Max. 164ft. (50m)

For latest generation of indoor units

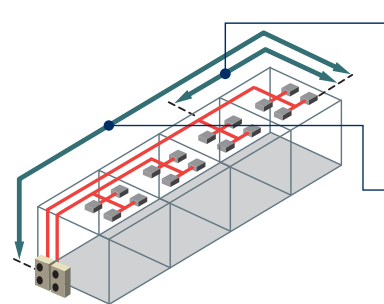

Piping length from first separation tube to the farthest indoor unit

Max. 295ft. (90m)

Actual piping length

Max. 393ft. (120m)

AOU72RLAVL, AOU96RLAVL, AOU120RLAVL



Specifications

Nominal system capacity		Ton	6	8	10
Model name			AOU72RLAVL	AOU96RLAVL	AOU120RLAVL
Indoor unit connectable capacity ratio			50% to 150%		
Maximum connectable indoor unit			1-18	1-24	1-30
Power source		Ø/V/Hz	208/230V, 3-Phase, 60Hz		
Capacity (Non-Ducted/Ducted)	Capacity	Btu/h	72,000	96,000	120,000
	EER	Btu/h/W	12.1/11.9	11.6/11.6	
	IEER	-	23.9/21.5	23.1/21.1	24.2/20.9
Capacity (Non-Ducted/Ducted)	Capacity	Btu/h	81,000	108,000	135,000
	COP at 47°F	W/W	4.19/4.01	3.87/3.66	3.77/3.64
Airflow rate		CFM(m ³ /h)	5,298(9,000)	6,475(11,000)	7,653(13,000)
Sound pressure level	Cooling/Heating	dB(A)	54/55	59/60	
	Height		64-1/2(1,638)		
	Width	in.(mm)	42-1/2(1,080)		
Weight		lbs.(kg)	470(213)		
Connection pipe diameter	Liquid	in.(mm)	3/8(9.52)		1/2(12.70)
	Gas		3/4(19.05)	7/8(22.20)	1-1/8(28.58)
Max.Total pipe length		ft.(m)	393(120)		
Max.height difference (Outdoor Unit: Upper/Lower)			164/131(50/40)		
Operation range	Cooling	°F(°C)	5* ¹ to 115 (-15* ¹ to 46)		23* ^{1,2} to 115 (-5* ^{1,2} to 46)
	Heating		-4 to 70(-20 to 21)		
Refrigerant type			R410A		
Maximum Circuit Breaker		A	40		50
Minimum Circuit Ampacity (MCA)		A	38	39	47

Note: Specifications are based on the following conditions: Cooling: Indoor temperature of 80°F (26.7°C)DB / 67°F (19.4°C) WB, and outdoor temperature of 95°F (35°C)DB / 75°F (23.9°C)WB. Heating: Indoor temperature of 70°F (21.1°C)DB / 60°F (15.6°C)WB, and outdoor temperature of 47°F (8.3°C)DB / 43°F (6.1°C)WB. Pipe length: 25ft. (7.5m), Height difference: 0ft. (0m). (Outdoor unit - indoor unit)

*1 When the outdoor unit is lower than the indoor unit, the temperature range is 23°F(-5°C).
 *2 The cooling operation range of 5 to 115°F(-15 to 46°C) is allowed only when all of the indoor units connected to the system are higher than capacity of 18000Btu/h(5.6kW).

Dimensions

(Units: in (mm))

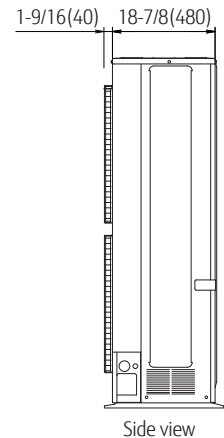
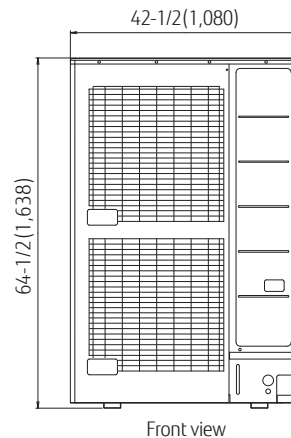
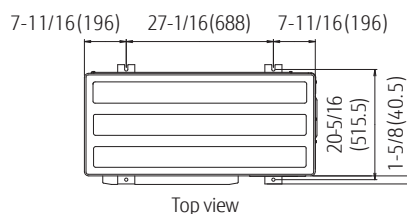

Heat Pump / Heat Recovery

3 Phase , 208/230V, 460V
6 to 36 tons

AIRSTAGE VU-V

Fujitsu General America's new VRF system, AIRSTAGE VU-V, represents the latest generation of VRF technology. It features many design improvements that yield higher performance and efficiency, wider operating ranges, greater design/installation flexibility, larger overall system capacities, and enhanced comfort.



Flexibility

Extended system capacity range – up to 36 Tons

Increased outdoor unit capacities saves space and costs.

Tons	6	8	10	12	14	16	18	20	22	24	26	28	30	32	34	36
Number of ODU Modules	1	1	1	1	1	1	2	2	2	2	2	2	2	2	3	3

Increased number of connectable indoor units

Improved design flexibility for applications with many indoor units such as hotels and offices.

Up to **42** indoor units
for **6 to 16** Ton systems

Up to **58** indoor units
for **18 to 22** Ton systems

Up to **64** indoor units
for **24** Ton and larger systems



Extended ambient air temperature operating range

- Heating down to -15°F as standard and high heating capacities enables the system to be used in cold regions
- Increases system application and design flexibility

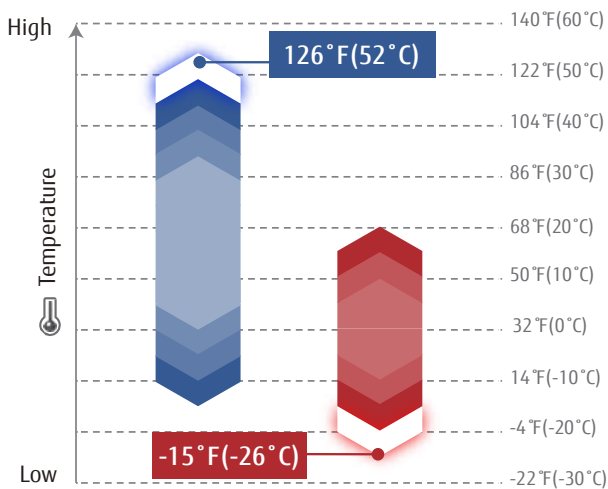

Unified outdoor units

The same outdoor unit can be used for both heat pump and heat recovery applications.

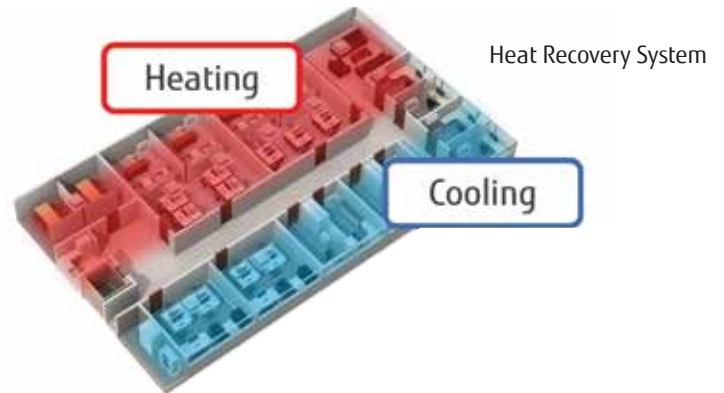
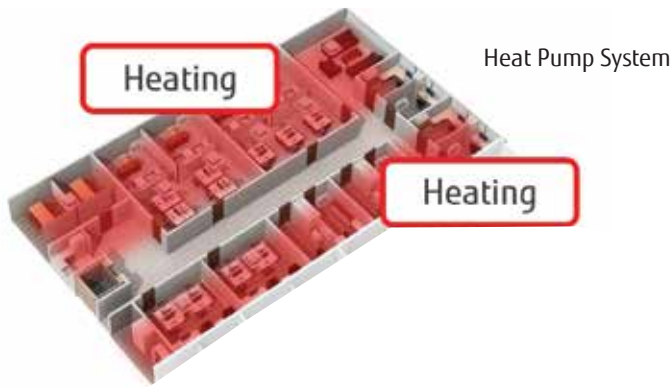

Service friendly design

Easy front access to electrical compartments, inverter board, compressors, fans, and other important piping components.

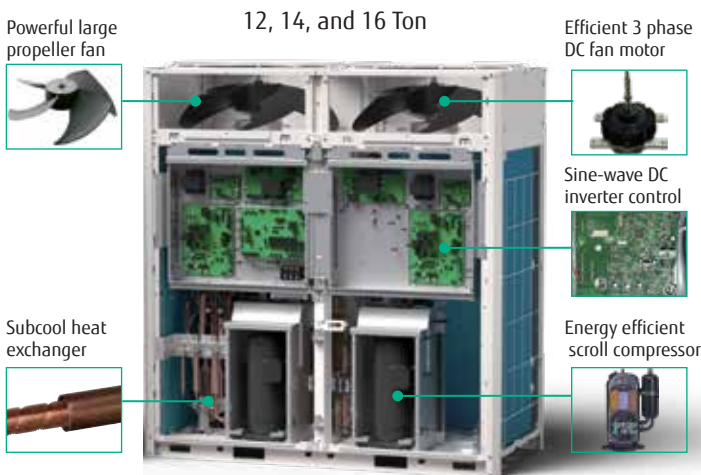

Reliable and efficient operation

Large sized refrigerant accumulator to prevent liquid from entering the compressor.

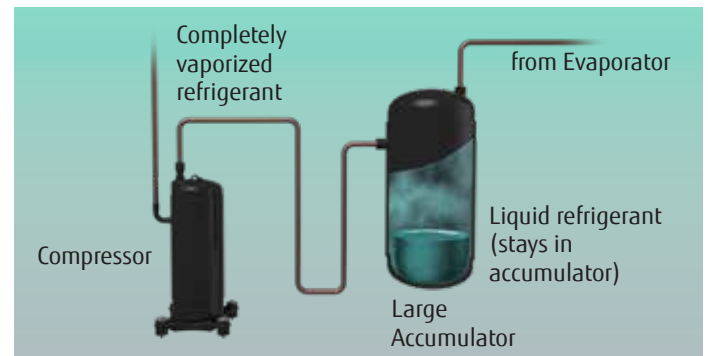

Refrigerant flow control

Refrigerant flow is automatically adjusted within the heat exchanger depending on airflow balance.

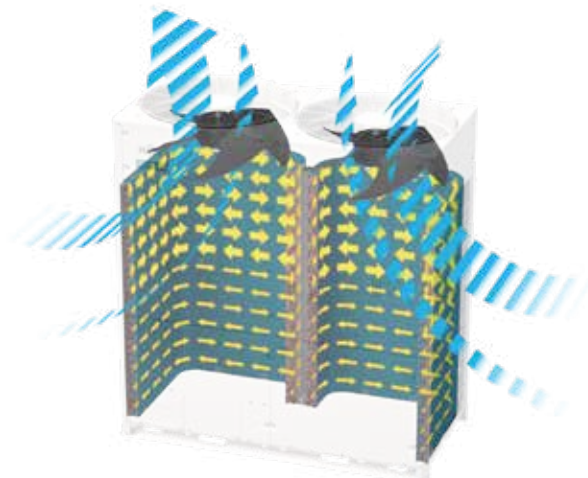

Service and maintenance window

Service window provides ease of access to multi-functional display and buttons without removing any main front panels.



Generous piping guidelines

Enables the VU-V system to be used in a variety of applications.

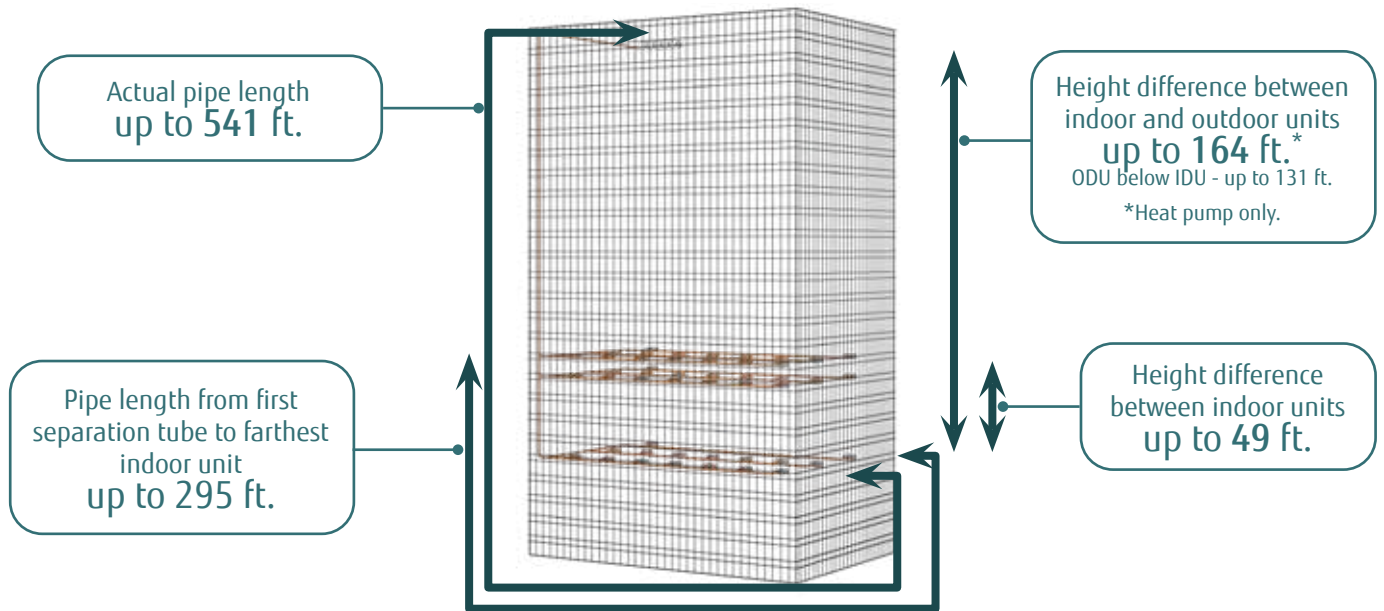

High static outdoor unit fan

Facilitates installations with outdoor units installed in tight spaces, or inside a building.

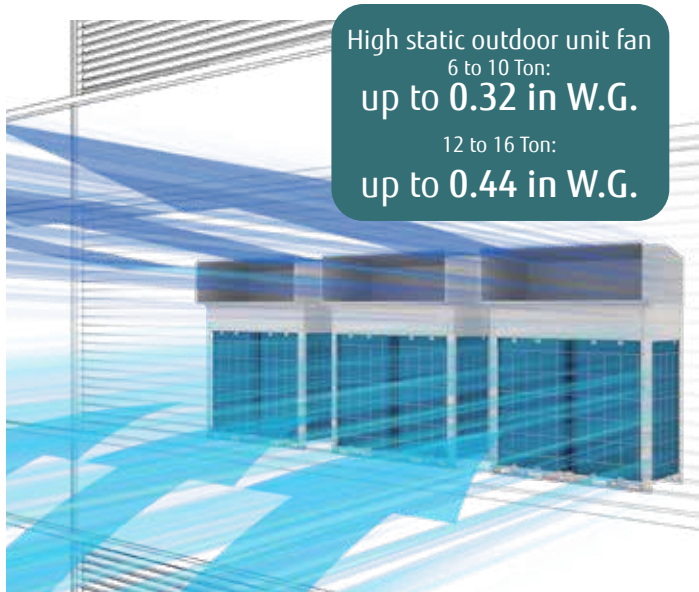

Intelligent refrigerant control

Optimizes the refrigerant temperature to provide year-round energy savings and individual comfort in each zone.

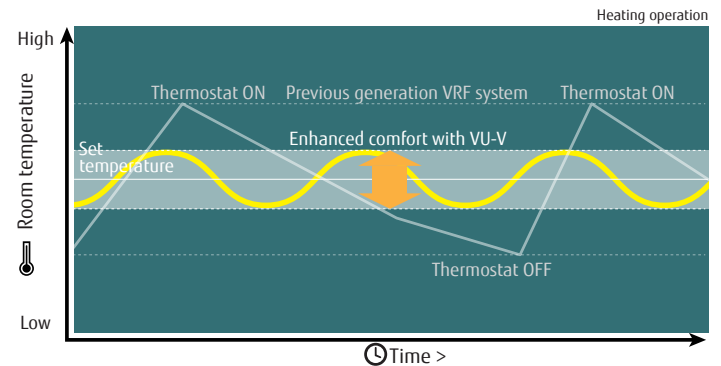

Continuous heating during defrost operation

Keeps the rooms served by a multi module system comfortable even during temporary defrost operation.

Single and multi type refrigerant branch units

Increases design flexibility and saves space and cost.

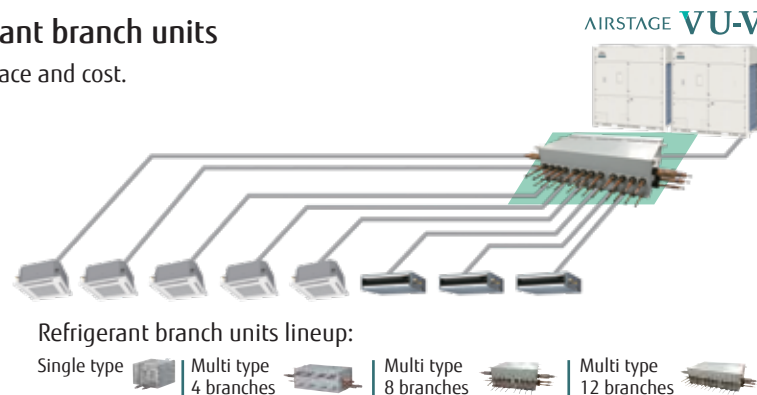

Specifications for 208 / 230 / 460V

Nominal Tonnage	Ton(s)	6	8	10	12	14
Model Name	Units	AQUA72ULBV5 / AQUA72ULCV5	AQUA96ULBV5 / AQUA96ULCV5	AQUA120ULBV5 / AQUA120ULCV5	AQUA144ULBV5 / AQUA144ULCV5	AQUA168ULBV5 / AQUA168ULCV5
Unit Group Configuration		1×(AQUA72ULBV5) / 1×(AQUA72ULCV5)	1×(AQUA96ULBV5) / 1×(AQUA96ULCV5)	1×(AQUA120ULBV5) / 1×(AQUA120ULCV5)	1×(AQUA144ULBV5) / 1×(AQUA144ULCV5)	1×(AQUA168ULBV5) / 1×(AQUA168ULCV5)
Indoor Unit Total Capacity		25%* to 150%			50% to 150%	
Maximum Connectable Indoor Units		16	21	26	32	37
CAPACITY						
Nominal Cooling Capacity	BTU/h [kW]	72,000 [21.1]	96,000 [28.1]	120,000 [35.2]	144,000 [42.2]	168,000 [49.2]
Cooling Power Input (Nominal)	kW	4.46 / 5.17	6.70 / 7.24	8.16 / 9.42	9.18 / 10.37	12.71 / 12.78
Nominal Heating Capacity	BTU/h [kW]	81,000 [23.7]	108,000 [31.7]	135,000 [39.6]	162,000 [47.5]	188,000 [55.1]
Heating Power Input (Nominal)	kW	4.95 / 5.56	7.31 / 7.52	9.93 / 9.63	10.73 / 10.92	13.60 / 13.55
ELECTRIC						
Electrical Power Requirements		208 / 230 VAC, 3-Phase, 60Hz / 460 VAC, 3-Phase, 60Hz				
Maximum Circuit Breaker	A	40 / 20	50 / 25	60 / 30	60 / 35	70 / 40
Minimum Circuit Ampacity (MCA)	A	29.3 / 17.3	37.7 / 21.9	43.9 / 24.9	49.8 / 29.8	59.8 / 34.8
EFFICIENCY						
Cooling (Non-Ducted/Ducted)	EER	12.3 / 14.9	13.2 / 11.7	13.5 / 11.3	14.4 / 12.2	12.2 / 11.5
Heating 17° (Non-Ducted/Ducted)	IEER	2.65 / 2.45	4.00 / 3.72	2.43 / 2.43	2.48 / 2.40	2.32 / 2.30
Heating 47° (Non-Ducted/Ducted)	COP	3.77 / 4.42	2.52 / 2.46	3.69 / 3.65	4.07 / 3.82	3.78 / 3.61
TEMPERATURE						
Operating Temp. Cooling (DB)	°F [°C]	14 to 126 [-10 to 52] / 5 to 126 [-15 to 52]				
Operating Temp. Heating (DB)	°F [°C]	-15 to 70 [-26 to 21]				
PIPE						
Pipe Connection: Liquid	in [mm]	3/8 [9.52]		1/2 [12.70]		5/8 [15.88]
Pipe Connection: Discharge Gas	in [mm]	3/4 [19.05]		3/4 [19.05]		7/8 [22.22]
REFRIGERANT						
Refrigerant Type		R410A				
Refrigerant Charge	lbs [kg]	25.79 [11.70]			26.01 [11.8]	
FAN						
Fan Airflow Rate	CFM [m3/h]	6533 [11,100]		7652 [13,000]		2×(6533 [11,100])
External Static Pressure (Max)	in.WG [Pa]	0.32 [80]				0.44 [110]
Sound Pressure Levels (Clg/Htg)	dB (A)	57 / 58	59 / 59	61 / 62	59 / 61	61 / 64
COMPRESSOR						
Compressor Type x Quantity		Scroll (inv) x 1			Scroll (inv) x 2	
Compressor Motor Output	kW	4.7		6.2		4.7 + 4.7
Compressor Crankcase Heater	W	35	35 x 2	35 x 2		35 x 2
DIMENSIONS / WEIGHT						
Dim.Net (HxWxD)	in [mm]	66-9/16 × 36-5/8 × 30-1/8 [1,690 × 930 × 765] /		66-9/16 × 48-13/16 × 30-1/8 [1,690 × 1240 × 765] /		66-9/16 × 63 × 30-1/8 [1,690 × 1,600 × 765]
Net Weight	lbs [kg]	569 [258] / 582 [264]		622 [282] / 582 [264]		930 [422] / 944 [428] / 944 [428] / 1041 [472]

*Only applicable for Heat Recovery models. Heat Pump models starts at 50%



Nominal Tonnage	Ton(s)	16	18	20	22	24
Model Name	Units	AQUA192ULBV5 / AQUA192ULCV5	AQUA216ULBV5 / AQUA216ULCV5	AQUA240ULBV5 / AOU- A240ULCV5	AQUA264ULBV5 / AQUA264ULCV5	AQUA288ULBV5 / AQUA288ULCV5
Unit Group Configuration		1×(AQUA192ULBV5) / 1×(AQUA192ULCV5)	1×(AQUA120ULBV5) / 1×(AQUA96ULBV5) / 1×(AQUA120ULCV5) / 1×(AQUA96ULCV5)	1×(AQUA120ULBV5) / 1×(AQUA120ULCV5) / 1×(AQUA120ULCV5)	1×(AQUA144ULBV5) / 1×(AQUA144ULCV5) / 1×(AQUA120ULCV5)	2×(AQUA144ULBV5) / 2×(AQUA144ULCV5)
Indoor Unit Total Capacity		50% to 150%				
Maximum Connectable Indoor Units		42	47	52	58	64
CAPACITY						
Nominal Cooling Capacity	BTU/h [kW]	192,000 [56.2]	216,000 [63.3]	240,000 [70.3]	264,000 [77.4]	288,000 [84.4]
Cooling Power Input (Nominal)	kW	16.31 / 15.62	18.41	20.48	20.92	27.46
Nominal Heating Capacity	BTU/h [kW]	216,000 [63.3]	243,000 [71.2]	270,000 [79.1]	297,000 [87.0]	324,000 [95.0]
Heating Power Input (Nominal)	kW	16.98 / 16.15	19.16	21.9	22.92	25.99
ELECTRIC						
Electrical Power Requirements		208 / 230 VAC, 3-Phase, 60Hz / 460 VAC, 3-Phase, 60Hz				
Maximum Circuit Breaker	A	80 / 50	110 / 55	(60) x 2 / (30) x 2	120 / 65	120 / 70
Minimum Circuit Ampacity (MCA)	A	71 / 41.5	43.9 + 37.7 / 24.9 + 21.9	43.9 + 43.9 / 24.9 + 24.9	49.8 + 43.9 / 29.8 + 24.9	49.8 + 49.8 / 29.8 + 29.8
EFFICIENCY						
Cooling (Non-Ducted/Ducted)	EER	11.0 / 10.9	10.9 / 10.9	10.9 / 10.9	11.7 / 11.2	9.8 / 10.0
Heating 17° (Non-Ducted/Ducted)	IEER	2.16 / 2.23	2.35 / 2.35	2.36 / 2.36	2.31 / 2.31	2.16 / 2.16
Heating 47° (Non-Ducted/Ducted)	COP	3.48 / 3.48	3.47 / 3.47	3.36 / 3.36	3.52 / 3.52	3.39 / 3.37
TEMPERATURE						
Operating Temp. Cooling (DB)	°F [°C]	14 to 126[-10 to 52] / 5 to 126[-15 to 52]				
Operating Temp. Heating (DB)	°F [°C]	-15 to 70[-26 to 21]				
PIPE						
Pipe Connection: Liquid	in [mm]	5/8 [15.88]				3/4 [19.05]
Pipe Connection: Discharge Gas	in [mm]	7/8 [22.22]	1-1/8 [28.58]			
REFRIGERANT						
Refrigerant Type		R410A				
Refrigerant Charge	lbs [kg]	26.01 [11.8]	(25.79 [11.70]) + (26.01 [11.80])	(26.01 [11.80]) x 2	(26.01 [11.80]) x 2	(25.79 [11.70]) x 3
FAN						
Fan Airflow Rate	CFM [m3/h]	13,067 [22200]	14,185 [24,100]	(7652 [13,000]) x 2	20,719 [35,200]	(6533 [11,100]) x 3
External Static Pressure (Max)	in.WG [Pa]	0.44 [110]	0.32 [80]	0.32 [80]	0.76[190]	0.44[110]
Sound Pressure Levels (Clg/Htg)	dB (A)	65 / 67	63 / 64	64 / 65	63 / 65	62 / 64
COMPRESSOR						
Compressor Type x Quantity		Scroll (inv) x 2			Scroll (inv) x 3	Scroll (inv) X 4
Compressor Motor Output	kW	4.7 + 4.7	4.7 + 6.2	6.2 + 6.2	4.7 + 4.7 + 6.2	4.7 + 4.7 + 4.7 + 4.7
Compressor Crankcase Heater	W	35 x 2	(35 x 2) x 2			(35 x 2) x 3
DIMENSIONS / WEIGHT						
Dim.Net (HxWxD)	in [mm]	66-9/16 x 63 x 30-1/8 [1,690 x 1,600 x 765]	(66-9/16 x 48-13/16 x 30-1/8) + (66-9/16 x 36-5/8 x 30-1/8) [1,690 x 1,240 x 765] + [1,690 x 930 x 765]	(66-9/16 x 48-13/16 x 30-1/8) x 2 [1,690 x 1,240 x 765] x 2	(66-9/16 x 63 x 30-1/8) + (66-9/16 x 48-13/16 x 30-1/8) [1,690 x 1,600 x 765] + [1,690 x 1,240 x 765]	(66-9/16 x 63 x 30-1/8) x 2 [1,690 x 1,600 x 765] x 2
Net Weight	lbs [kg]	930 [422] / 944 [428]	1,191 [540] / 1,217 [552]	622 [282] x 2 / 635 [288] x 2	1,552 [704] / 1,579 [716]	930 [422] x 2 / 944 [428] x 2

Cont'd →



OUTDOOR UNITS

Specifications

Nominal Tonnage	Ton(s)	26	28	30	32	34	36
Model Name	Units	AOUA312ULBVG5 / AOUA312ULCVG5	AOUA336ULBVG5 / AOUA336ULCVG5	AOUA360ULBVG5 / AOUA360ULCVG5	AOUA384ULBVG5 / AOUA384ULCVG5	AOUA408ULBVG5 / AOUA408ULCVG5	AOUA432ULBVG5 / AOUA432ULCVG5
Unit Group Configuration		1×(AOUA144ULBV5) / 1×(AOUA168ULBV5) / 1×(AOUA144ULCV5) / 1×(AOUA168ULCV5)	2×(AOUA168ULBV5) / 2×(AOUA168ULCV5)	1×(AOUA192ULBV5) / 1×(AOUA168ULBV5) / 1×(AOUA192ULCV5) / 1×(AOUA168ULCV5)	2×(AOUA192ULBV5) / 2×(AOUA192ULCV5)	2×(AOUA144ULBV5) / 1×(AOUA120ULBV5) / 2×(AOUA144ULCV5) / 1×(AOUA120ULCV5)	3×(AOUA144ULBV5) / 3×(AOUA144ULCV5)
Indoor Unit Total Capacity		50% to 150%					
Maximum Connectable Indoor Units		64	64	64	64	64	64
CAPACITY							
Nominal Cooling Capacity	BTU/h [kW]	312,000[91.4]	336,000[98.5]	360,000[105.5]	384,000[112.5]	408,000[119.6]	432,000[126.6]
Cooling Power Input (Nominal)	kW	29.70	31.81	34.15	36.37	34.36	37.09
Nominal Heating Capacity	BTU/h [kW]	351,000[102.9]	378,000[99.1]	405,000[118.7]	432,000[126.6]	459,000[134.5]	486,000[142.4]
Heating Power Input (Nominal)	kW	27.02	28.46	29.0	29.72	32.38	32.57
ELECTRIC							
Electrical Power Requirements		208 / 230 VAC, 3-Phase, 60Hz / 460 VAC, 3-Phase, 60Hz					
Maximum Circuit Breaker	A	130 / 70	140 / 80	150 / 90	160 / 100	180 / 100	180 / 105
Minimum Circuit Ampacity (MCA)	A	59.8 + 49.8 / 34.8 + 29.8	59.8 + 59.8 / 34.8 + 34.8	71.0 + 59.8 / 41.5 + 34.8	71.0 + 71.0 / 41.5 + 41.5	49.8 + 49.8 + 43.9 / 29.8 + 29.8 + 24.9	49.8 + 49.8 + 49.8 / 29.8 + 29.8 + 29.8
EFFICIENCY							
Cooling (Non-Ducted/Ducted)	EER	9.8 / 10.0				11.0 / 11.0	10.8 / 10.8
Heating 17° (Non-Ducted/Ducted)	IEER	2.16 / 2.16				2.31 / 2.31	2.3 / 2.3
Heating 47° (Non-Ducted/Ducted)	COP	3.39 / 3.37				3.46 / 3.46	3.53 / 3.53
TEMPERATURE							
Operating Temp. Cooling (DB)	°F [°C]	14 to 126 [-10 to 52] / 5 to 126 [-15 to 52]					
Operating Temp. Heating (DB)	°F [°C]	-15 to 70 [-26 to 21]					
PIPE							
Pipe Connection: Liquid	in [mm]	3/4 [19.05]					
Pipe Connection: Discharge Gas	in [mm]	1-1/8 [28.58]				1-3/8 [34.92]	
REFRIGERANT							
Refrigerant Type		R410A					
Refrigerant Charge	lbs [kg]	26.01 [11.80] x 2				26.01 [11.80] x 3	
FAN							
Fan Airflow Rate	CFM [m3/h]	13,067 [22,200] x 2				33,786 [57,400]	13,067 [22,200] x 3
External Static Pressure (Max)	in.WG [Pa]	0.44 [110]					
Sound Pressure Levels (Clg/Htg)	dB (A)	63 / 66	64 / 67	66 / 69	68 / 70	63 / 64	64 / 65
COMPRESSOR							
Compressor Type x Quantity		Scroll (inv) x 4				Scroll (inv) x 5	Scroll (inv) x 6
Compressor Motor Output	kW	4.7 + 4.7 + 4.7 + 4.7				4.7 + 4.7 + 4.7 + 4.7 + 6.2	4.7 + 4.7 + 4.7 + 4.7 + 4.7
Compressor Crankcase Heater	W	[35 x 2] x 4				35 x 4	
DIMENSIONS / WEIGHT							
Dim.Net (HxWxD)	in [mm]	66-9/16 x 63 x 30-1/8) x 2 [1,690 x 1,600 x 765] x 2				(66-9/16 x 63 x 30-1/8) x 2 (66-9/16 x 48-13/16 x 30-1/8) [1,690 x 1,600 x 765] x 2 [1,690 x 1,240 x 765]	(66-9/16 x 63 x 30-1/8) x 3 [1,690 x 1,600 x 765] x 3
Net Weight	lbs [kg]	930 [422] x 2 / 944 [428] x 2				2482 [1,126] / 2,523 [1,144]	930 [422] x 3 / 944 [428] x 3

Dimensions

(Units: in (mm))

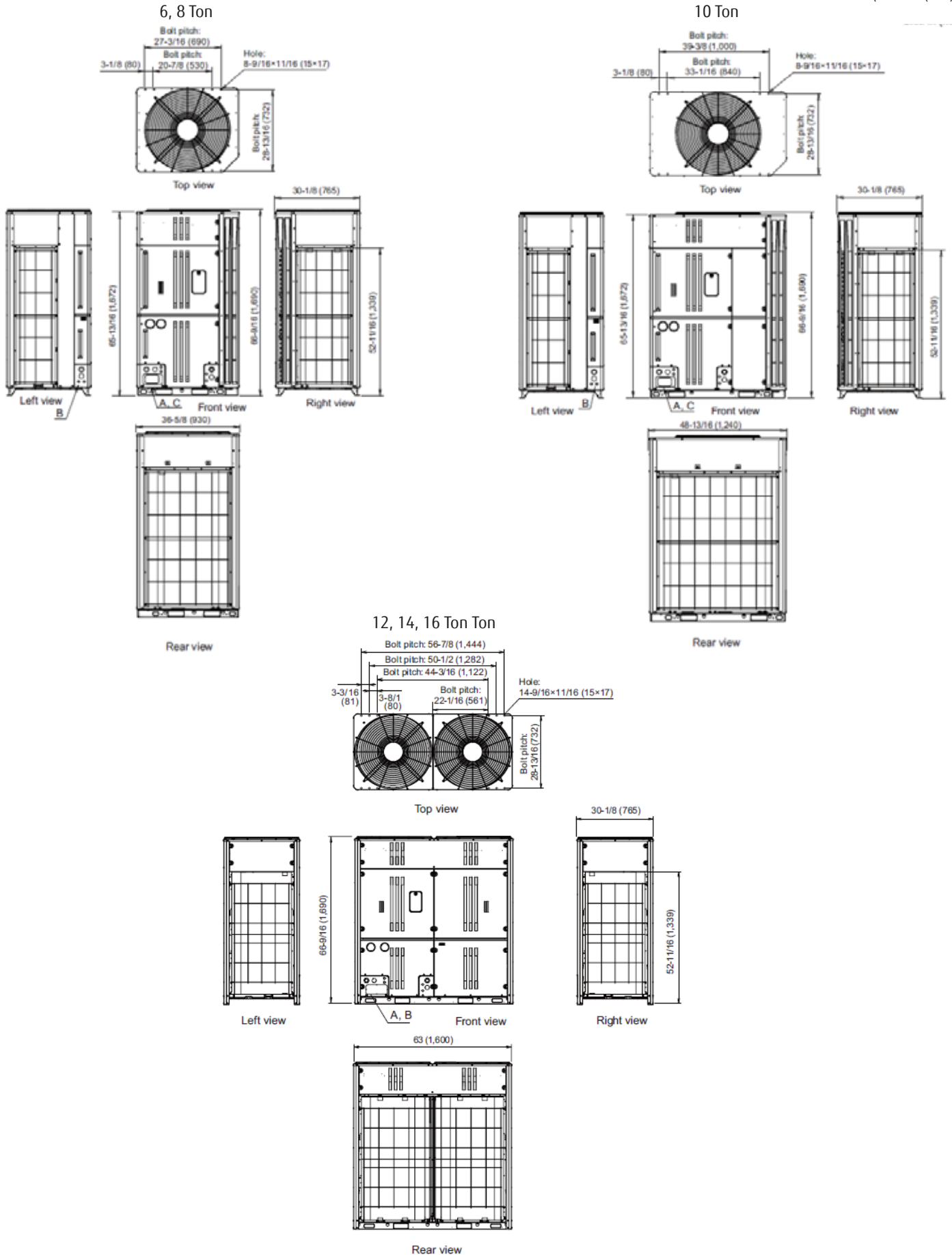

VRF INDOOR UNITS

The Fujitsu AIRSTAGE indoor unit range is one of the widest on the market, offering 13 stylish and elegant indoor unit types in 58 different models. All designed to blend into any environment, maximize comfort, minimize operating sound and simplify installation and servicing.

- p. 46 Compact Cassette
- p. 48 Large Circular Flow Cassette
- p. 50 Slim Compact Duct
- p. 52 Medium Static Pressure Duct
- p. 54 High Static Pressure Duct (ARUH36, 48, 60)
- p. 56 High Static Pressure Duct (ARUH72, 96)
- p. 58 Multi-Position Air Handling Unit
- p. 60 Floor Mount
- p. 62 Floor/Ceiling
- p. 64 Ceiling
- p. 66 Compact Wall Mounted
- p. 68 Wall Mounted
- p. 70 DX-Kit



Compact Cassette

- AUUA4TLAV2 AUUA14TLAV2
- AUUA7TLAV2 AUUA18TLAV2
- AUUA9TLAV2 AUUA24TLAV2
- AUUA12TLAV2



Compact size panel design that fits in a standard 24" square ceiling panel (600 x 600mm)

Note: IR Receiver is standard for communicating with optional Wireless Remote Control.
Compact Cassette Grille UTG-CCGVG sold separately. Must order one with each compact cassette.

2-stage turbo fan

2-stage fan design for high efficiency

High efficiency heat transfer due to 2 stage turbo fan with dual airflow for even air distribution across the heat exchanger.

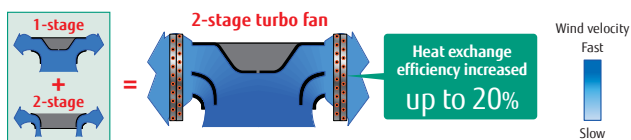

Quiet

Optimized fan blade design for low noise and high performance

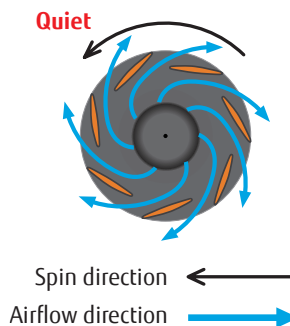

Specifications

Model		AUUA4TLAV2	AUUA7TLAV2	AUUA9TLAV2	AUUA12TLAV2	AUUA14TLAV2	AUUA18TLAV2	AUUA24TLAV2	
Power source		1 Phase - 208/230V 60Hz							
Capacity	Cooling	BTU/h	4,000	7,500	9,500	12,000	14,000	18,000	24,000
		kW	1.2	2.2	2.8	3.5	4.1	5.3	7.0
	Heating	BTU/h	4,400	9,500	10,900	13,500	15,600	20,000	27,000
		kW	1.3	2.8	3.2	4.0	4.6	5.9	7.9
Input power		W	23	25	25	29	35	36	84
Airflow rate	High	CFM (m ³ /h)	312 (530)	318 (540)	324 (550)	353 (600)	400 (680)	418 (710)	606 (1,030)
	Med		265 (450) / 247 (420)	265 (450)	265 (450)	312 (530)	347 (590)	341 (580)	489 (830)
	Low		206 (350) / 177 (300)	206 (350)	206 (350)	230 (390)	230 (390)	235 (400)	265 (450)
Sound pressure level	High	dB (A)	34	34	35	37	38	41	50
	Med		30 / 28	30	30	34	34	35	44
	Low		25 / 21	25	25	27	27	27	30
Dimensions (H × W × D)		in. (mm)	9-5/8 × 22-7/16 × 22-7/16 (245 × 570 × 570)						
Weight		lbs. (kg)	32 (14.5)	33 (15)	33 (15)	33 (15)	33 (15)	37 (17)	37 (17)
Connection pipe diameter	Liquid (Flare)	in. (mm)	1/4 (6.35)	1/4 (6.35)	1/4 (6.35)	1/4 (6.35)	1/4 (6.35)	3/8 (9.52)	3/8 (9.52)
	Gas (Flare)		3/8 (9.52)	1/2 (12.70)	1/2 (12.70)	1/2 (12.70)	1/2 (12.70)	5/8 (15.88)	5/8 (15.88)
Drain hose diameter (I.D./O.U.)			3/4 / 1-1/16						
Cassette Grille	Model name		UTG-CCGVG						
	Dimensions (H×W×D)		1-15/16 × 24-7/16 × 24-7/16 (49 × 620 × 620)						
	Weight		5.1 (2.3)						

Note : Specifications are based on the following conditions.

Cooling : Indoor temperature of 80°F (26.7°C) DB/67°F (19.4°C) WB, and outdoor temperature of 95.0°F (35°C) DB/75°F (23.9°C) WB.

Heating : Indoor temperature of 70°F (21.1°C) DB/60°F (15.6°C) WB, and outdoor temperature of 47°F (8.3°C) DB/43°F (6.1°C) WB.

Pipe length : 25ft. (7.5 m), Height difference : 0ft. (0 m) (Outdoor unit - Indoor unit).

Built-in protective functions may limit capacity or shut off unit if unit is operated outside of unit design operating temperature ranges.

Optimized airflow distribution

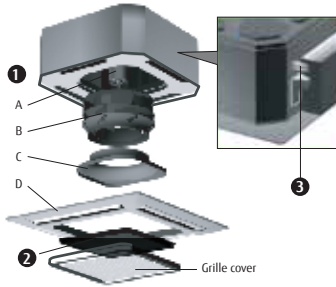

1 Easy maintenance of fan and motor

Access and maintenance of the fan and motor can easily be done removing a panel. Both fan and motor can easily be removed for repair or replacement.

A : Fan motor B : 2-stage turbo fan
C : Bell-mouth D : Grille Panel

2 Air filter

Standard equipment

3 Transparent condensate drain parts

During installation, maintenance and operation, the condensate drain pump can easily be inspected.

High lift pump

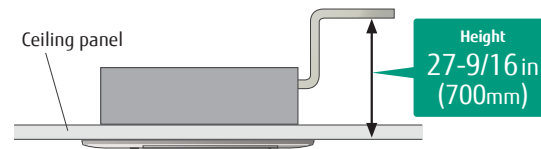

Built-in condensate drain pump

High ceiling mode

AUUA12/14/18/24TLAV2 models only -The compact cassette can be installed up to a height of 9'10-1/8" ft. (3.0m)

BTU/h	Max height from floor to ceiling (ft.(m))	
	Standard mode	High ceiling mode
4,000	8'10-5/16" (2.7)	-
7,000	8'10-5/16" (2.7)	-
9,000	8'10-5/16" (2.7)	-
12,000	8'10-5/16" (2.7)	9'10-1/8" (3.0)
14,000	8'10-5/16" (2.7)	9'10-1/8" (3.0)
18,000	8'10-5/16" (2.7)	9'10-1/8" (3.0)
24,000	8'10-5/16" (2.7)	9'10-1/8" (3.0)

Compact design

Industry leading 24,000 BTU/h model in the compact cassette category Fits standard 24" ceiling grid.



Optional Accessories

- Kagami Wired Remote ControlUTY-RVRU
- Wired Remote Control (Touch Panel) UTY-RNRUZ*
- Simple Remote Control UTY-RSRY, UTY-RHRY
- Wireless Remote Control..... UTY-LNHU
- Wi-Fi Interface Module UTY-TFSXJ4
- Air Outlet Shutter Plate UTR-YDZB
- Fresh Air Intake Kit.....UTZ-VXAA
- Insulation Kit for High Humidity..... UTZ-KXGC

Dimensions

(Unit: In (mm))

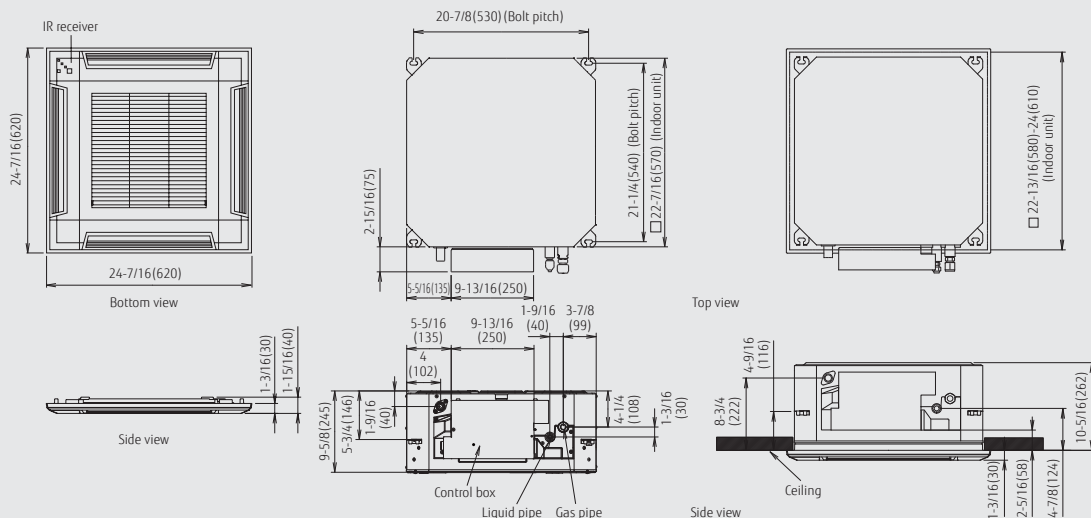

Large Circular Flow Cassette

- AUUB12TLAV2 (reduced height)
- AUUB14TLAV2 (reduced height)
- AUUB18TLAV2 (reduced height)
- AUUB24TLAV2 (reduced height)
- AUUB30TLAV2 (reduced height)
- AUUB36TLAV2
- AUUB48TLAV2



Cassette grille also available in black

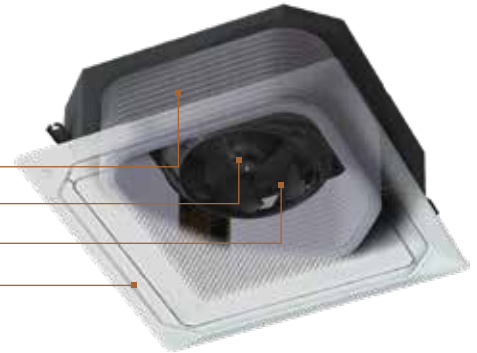

- High density heat exchanger
- DC fan motor
- High efficient turbo fan
- Seamless airflow louver

Unique circular air flow design

Unique seamless airflow louver design with 360° air exhaust for even and comfortable temperatures anywhere in the room.

360° louvers for efficient air distribution

Circular air exhaust allows conditioned air to reach all areas of the room.

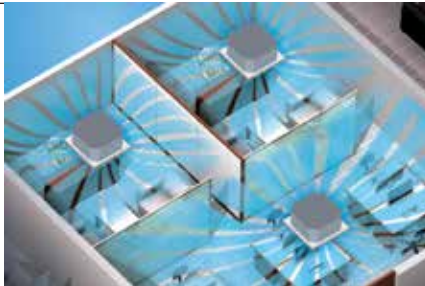

Integral Condensate Pump

Lift of up to 33 in.

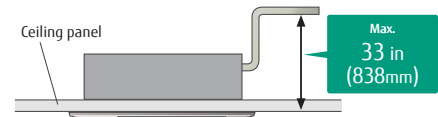

Specifications

Model name		AUUB12TLAV2	AUUB14TLAV2	AUUB18TLAV2	AUUB24TLAV2	AUUB30TLAV2	AUUB36TLAV2	AUUB48TLAV2			
Power Source		1 Phase - 208 / 230 V ~ 60 Hz						1 Phase - 208 / 230 V ~ 60 Hz			
Capacity	Cooling	BTU/h kW	12,000 3.5	14,000 4.1	18,000 5.3	24,000 7.0	30,000 8.8	36,000 10.6	48,000 14.1		
	Heating	BTU/h kW	13,500 4.0	15,600 4.6	20,000 5.9	27,000 7.9	34,000 10.0	40,000 11.7	54,000 15.8		
Input Power		W	20	20	20	25	49	61	116		
Airflow rate	High	CFM (m ³ /h)	618 (1,050)	618 (1,050)	618 (1,050)	659 (1,120)	865 (1,470)	954 (1,620)	1,201 (2,040)		
	Med-Hi		547 (930)	547 (930)	547 (930)	618 (1,050)	683 (1,160)	883 (1,500)	1,059 (1,800)		
	Med		530 (900)	530 (900)	530 (900)	547 (930)	630 (1,070)	824 (1,400)	936 (1,590)		
	Lo-Hi		512 (870)	512 (870)	512 (870)	530 (900)	547 (930)	789 (1,340)	848 (1,440)		
	Low		477 (810)	477 (810)	477 (810)	512 (870)	530 (900)	753 (1,280)	765 (1,300)		
	Quiet	459 (780)	459 (780)	459 (780)	459 (780)	459 (780)	677 (1,150)	677 (1,150)			
Sound pressure level	High	dB(A)	33	33	33	35	40	41	47		
	Med-Hi		32	32	32	33	36	40	45		
	Med		31	31	31	32	34	38	42		
	Lo-Hi		30	30	30	31	32	37	39		
	Low		29	29	29	30	31	35	36		
	Quiet	28	28	28	28	28	33	33			
Dimensions (H x W x D)		in.(mm)	9-11/16 x 33-1/16 x 33-1/16 (246 x 840 x 840)						11-5/16 x 33-1/16 x 33-1/16 (288 x 840 x 840)		
Weight		lbs.(kg)	53 (24)	53 (24)	53 (24)	54 (24.5)	54 (24.5)	65 (29.5)	65 (29.5)		
Connection pipe diameter	Liquid (Flare)	in.(mm)	1/4 (6.35)	1/4 (6.35)	1/4 (6.35)	3/8 (9.52)	3/8 (9.52)	3/8 (9.52)	3/8 (9.52)		
	Gas (Flare)		1/2 (12.70)	1/2 (12.70)	1/2 (12.70)	5/8 (15.88)	5/8 (15.88)	5/8 (15.88)	5/8 (15.88)		
Condensate Drain hose diameter (I.D./O.D.)		in.	3/4 / 1-1/16						3/4 / 1-1/16		
Cassette Grille	Model name		UTG-LCGVCW / UTG-LCGVCB						UTG-LCGVCW / UTG-LCGVCB		
	Dimensions (H*W*D)		in.(mm)	2-1/16 x 37-3/8 x 37-3/8 (53 x 950 x 950)						2-1/16 x 37-3/8 x 37-3/8 (53 x 950 x 950)	
	Weight		lbs.(kg)	13.0 (6.0)	13.0 (6.0)	13.0 (6.0)	13.0 (6.0)	13.0 (6.0)	13.0 (6.0)	13.0 (6.0)	

Note : Specifications are based on the following conditions: Built-in protective functions may limit capacity or shut off unit if unit is operated outside of unit design operating temperature ranges. Cooling : Indoor temperature of 80°F(26.7°C)DB/67°F(19.4°C)WB; and outdoor temperature of 95°F(35°C)DB/75°F(23.9°C)WB. Heating : Indoor temperature of 70°F(21.1°C)DB/60°F(15.6°C)WB, and outdoor temperature of 47°F(8.3°C)DB/43°F(6.1°C)WB. Pipe Length : 25ft. (7.5m), Height difference : 0ft.(0m) (Outdoor unit - indoor unit).

Individual louver control

Individually controlled louvers for comfortable air distribution in any room configuration. Compatible remotes and central controllers are: Kagami Wired RC (UTY-RVRU) / Touch Panel Wired RC (UTY-RNRUZ*) / AIRSTAGE Edge Controller (UTY-DSGYZ2) / Central Remote Controller (UTY-DCGYZ2) / System Controller (UTY-APGXZ1) / System Controller Lite (UTY-ALGXZ1).

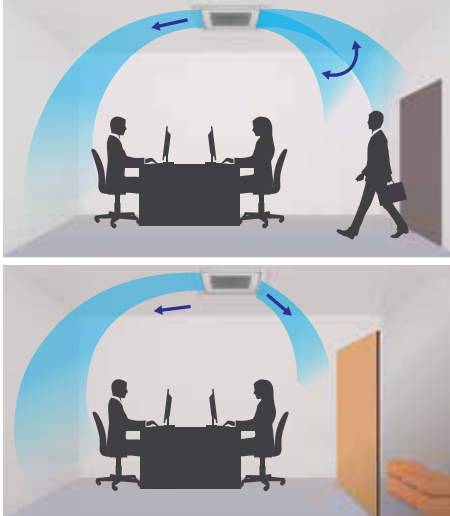

Louvers adjust air flow direction for constant comfort for people in the room.

Occupancy/human sensor setting (optional)

Saves energy by automatically turning off the unit if the room is unoccupied.

2 modes can be selected.

Auto saving

Power is saved while no one is around

Auto OFF

Operation is stopped while no one is around

Human Sensor feature control is available through Kagami Wired RC (UTY-RVRU) and Touch Panel Wired RC (UTY-RNRUZ).



Quiet operation with 6 fan speed control

With 6 fan speeds to choose from, circular flow cassette models operate at whisper quiet sound levels.

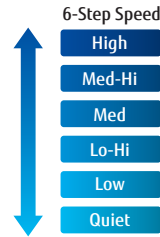

* Compatible Remote Controllers: UTY-RVRU / UTY-RNRUZ* / UTY-RSRY / UTY-RHRY / UTY-DSGYZ2 / UTY-DCGYZ2 / UTY-ALGXZ1 / UTY-APGXZ1

Optional Accessories

Kagami Wired Remote Control UTY-RVRU
 Wired Remote Control (Touch Panel) UTY-RNRUZ*
 Simple Remote Control UTY-RSRY, UTY-RHRY
 IR Receiver UTB-LBHDX
 Wireless Remote Controller UTY-LNHU
 Wi-Fi Interface Module UTY-TFSXJ4

Human Sensor Kit UTY-SHZXC
 Air Outlet Shutter Plate UTR-YDZK
 Wide Panel UTG-AKXA-W
 Panel Spacer UTG-BKXA-W
 Insulation Kit For High Humidity - 18-24k UTZ-KXGB
 Insulation Kit For High Humidity - 30-36-48k UTZ-KXGA

Dimensions

(Unit: In (mm))

Models:

AUUB12TLAV2 / AUUB14TLAV2 / AUUB18TLAV2 /
 AUUB24TLAV2 / AUUB30TLAV2

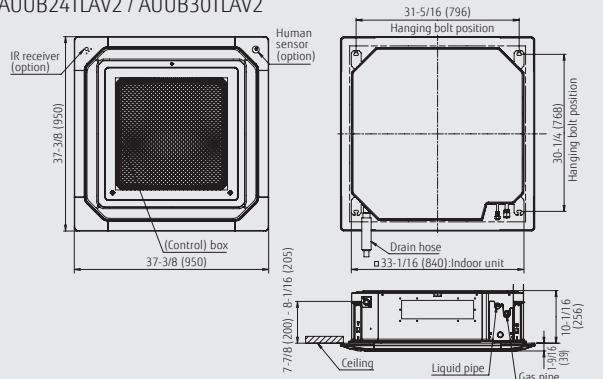

AUUB36TLAV2 / AUUB48TLAV2

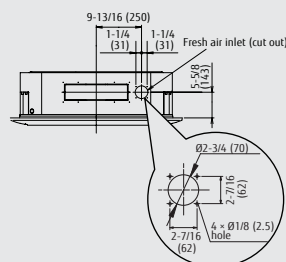
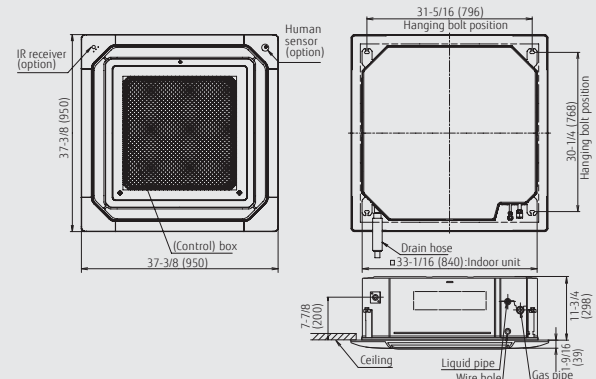

Slim Compact Duct

- ARUL4TLAV2 MINI
- ARUL7TLAV2 SLIM
- ARUL9TLAV2 SLIM
- ARUL12TLAV2 SLIM
- ARUL14TLAV2 SLIM
- ARUL18TLAV2 SLIM



ARUL4TLAV2



ARUL7, 9, 12, 14TLAV2



ARUL18TLAV2



Shown with optional Auto Louver Grille Kit (UTD-GXTA-W, UTD-GXSA-W, UTD-GXSB-W)

Slim design, wide range of static pressure settings and flexible installation orientation.

Slim design

Slim and compact design for flexibility to be installed in narrow spaces.

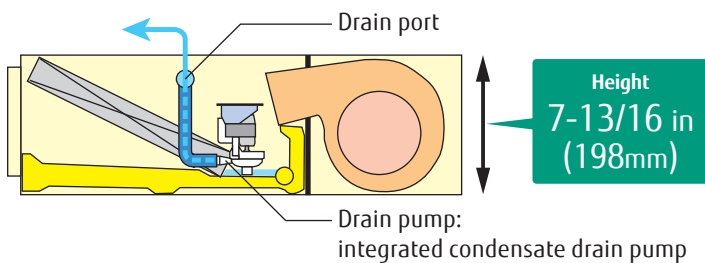

Flexible installation

Can be mounted horizontally or vertically and deliver up to 0.36 in. WG static pressure for flexibility to fit many different application needs. Note: mini duct (ARUL4TLAV2 is horizontal installation only).

Ceiling concealed

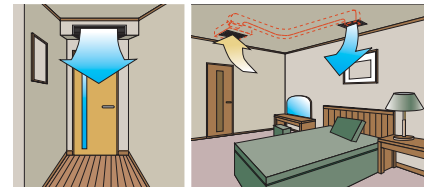

Floor concealed

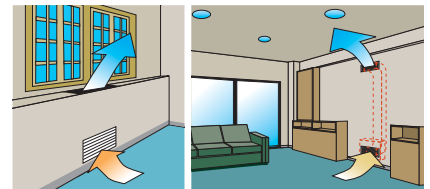

Specifications

Model name		ARUL4TLAV2	ARUL7TLAV2	ARUL9TLAV2	ARUL12TLAV2	ARUL14TLAV2	ARUL18TLAV2	
Power source		1 Phase - 208/230V 60Hz						
Capacity	Cooling	BTU/h	4,000	7,500	9,500	12,000	14,000	18,000
		kW	1.2	2.2	2.8	3.5	4.1	5.3
	Heating	BTU/h	4,400	9,500	10,900	13,500	15,600	20,000
		kW	1.3	2.8	3.2	4.0	4.6	5.9
Input power		W	26	44	50	54	92	83
Airflow rate	High	CFM (m ³ /h)	271 (460)	324 (550)	353 (600)	353 (600)	471 (800)	553 (940)
	Med		247 (420)	288 (490)	324 (550)	300 (510)	418 (710)	494 (840)
	Low		218 (370)	258 (440)	283 (480)	265 (450)	359 (610)	441 (750)
Static pressure range		in.WG	0 to 0.12 (0 to 30)	0 to 0.36 (0 to 90)	0 to 0.36 (0 to 90)	0 to 0.36 (0 to 90)	0 to 0.36 (0 to 90)	0 to 0.36 (0 to 90)
Standard static pressure		(Pa)	0.04 (10)	0.10 (25)	0.10 (25)	0.10 (25)	0.10 (25)	0.10 (25)
Sound pressure level	High	dB (A)	25	28	29	30	34	34
	Med		23	25	26	27	32	32
	Low		21	22	24	24	28	28
Dimensions (H x W x D)		in.(mm)	7-13/16 x 27-9/16 x 17-11/16 (198 x 700 x 450)	7-13/16 x 27-9/16 x 24-7/16 (198 x 700 x 620)			7-13/16 x 35-7/16 x 24-7/16 (198 x 900 x 620)	
Weight		lbs.(kg)	32 (14.5)	37 (17)	37 (17)	40 (18)	40 (18)	49 (22)
Connection pipe diameter	Liquid (Flare)		1/4 (6.35)	1/4 (6.35)	1/4 (6.35)	1/4 (6.35)	1/4 (6.35)	3/8 (9.52)
	Gas (Flare)	in.(mm)	3/8 (9.52)	1/2 (12.70)	1/2 (12.70)	1/2 (12.70)	1/2 (12.70)	5/8 (15.88)
Drain hose diameter (I.D./O.U.)			3/4 / 1-1/16					

Note : Specifications are based on the following conditions.

Cooling : Indoor temperature of 80°F(26.7°C)DB/67°F(19.4°C)WB,and outdoor temperature of 95.0°F(35°C)DB/75°F(23.9°C)WB.

Heating : Indoor temperature of 70°F(21.1°C)DB/60°F(15.6°C)WB,and outdoor temperature of 47°F(8.3°C)DB/43°F(6.1°C)WB.

Pipe length : 25ft.(7.5 m), Height difference : 0ft.(0 m) (Outdoor unit - Indoor unit).

Built-in protective functions may limit capacity or shut off unit if unit is operated outside of unit design operating temperature ranges.

Condensate drain pump (Standard)

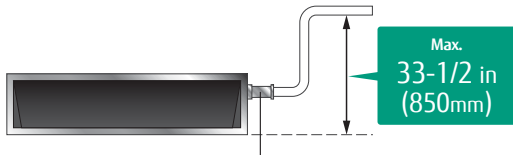

Filter (Included)

ARUL7 / 9 / 12 / 14 / 18
Minimum Height Requirement 9-3/4"

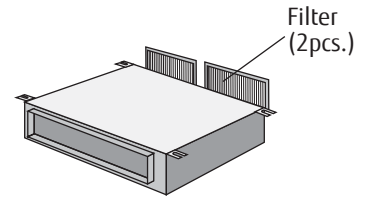

Selectable external static pressure

External static pressure can be selected from 0 up to 0.36 in. WG with remote controller.



Static pressure range
0.1 to 0.36 in.WG
(0 to 90Pa)

Auto Louver Grille Kit (Option)

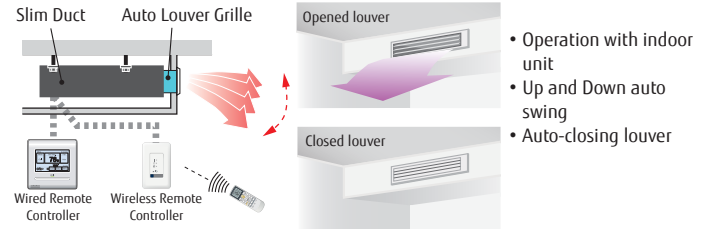

Air inlet

Flexible with alternative air inlets to fit any layout.

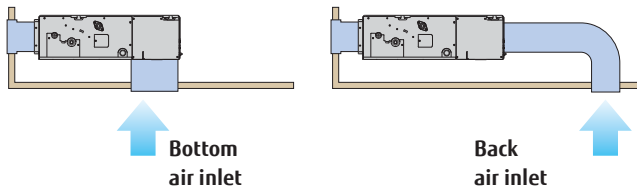

Optional Accessories

- Auto Louver Grille Kit..... UTD-GXTA-W (for ARUL4TLAV2)
UTD-GXSA-W (for ARUL7/9/12/14TLAV2)
UTD-GXSB-W (for ARUL18TLAV2)
- IR Receiver UTB-TRH
- Wireless Remote Controller UTY-LNHU
- Remote Sensor Unit..... UTY-XSZXZ1

Dimensions

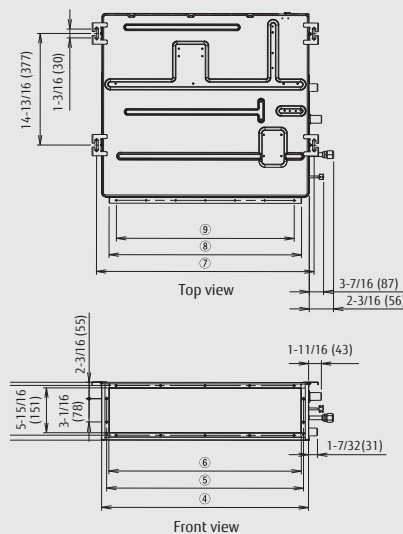

(Unit: In (mm))

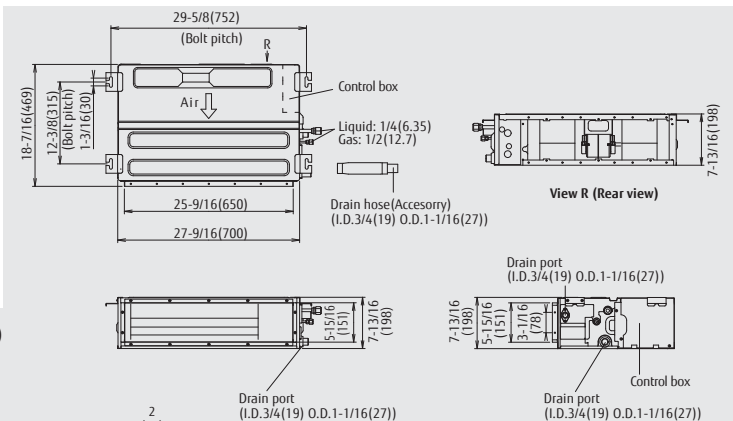
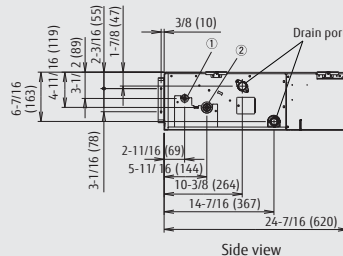
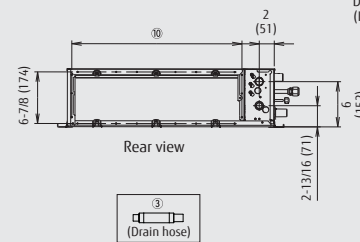

	ARUL 7/9/12/14	ARUL 18
① Refrigerant pipe flare connection (Liquid)	ø 1/4 (6.35)	ø 3/8 (9.52)
② Refrigerant pipe flare connection (Gas)	ø 1/2 (12.70)	ø 5/8 (15.88)
③ Drain hose connection (Drain Hose)	ø 3/4 (I.D.), ø 1-1/16 (O.D.)	
④	27-9/16 (700)	35-7/16 (900)
⑤	26-1/8 (664)	34 (864)
⑥	25-9/16 (650)	33-7/16 (850)
⑦	28-7/8 (734)	36-3/4 (934)
⑧	25-9/16 (650)	33-7/16 (850)
⑨	3-15/16 (100) x 6 = 23-5/8 (600) 3-15/16 (100) x 8 = 31-1/2 (800)	
⑩	22-5/8 (574)	30-1/2 (774)

Medium Static Pressure Duct

ARUM24TLAV2
 ARUM30TLAV2
 ARUM36TLAV2



Slim & Compact design

Compact, slim height, and integrated control box makes the indoor unit suitable for applications where the height is limited.

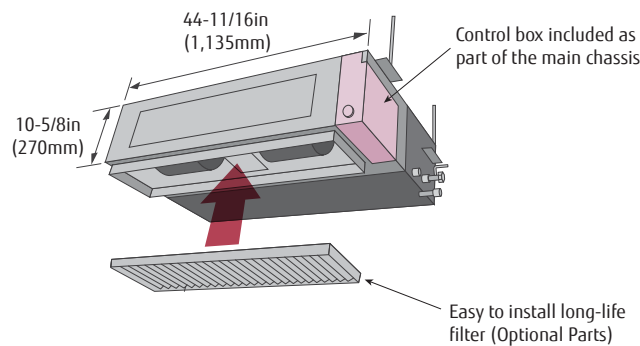

Easy maintenance

Maintenance friendly design with easy access to motor and fan by quickly removing two bottom panels on the indoor unit.

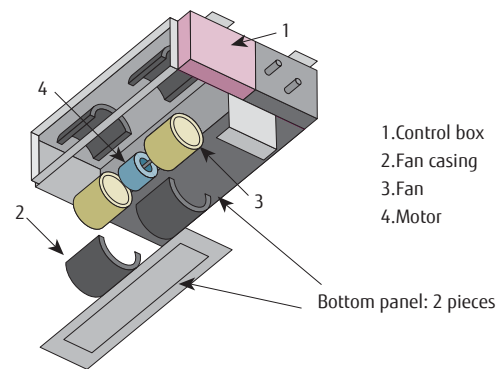

Specifications

Model name			ARUM24TLAV2	ARUM30TLAV2	ARUM36TLAV2
Power source			1 Phase - 208/230V 60Hz		
Capacity	Cooling	BTU/h	24,000	30,000	36,000
		kW	7.0	8.8	10.6
	Heating	BTU/h	27,000	34,000	40,000
		kW	7.9	10.0	11.7
Input power		W	125	190	222
Airflow rate	High	CFM (m ³ /h)	859 (1,460)	1,042 (1,770)	1,112 (1,890)
	Med		724 (1,230)	812 (1,380)	895 (1,520)
	Low		589 (1,000)	589 (1,000)	677 (1,150)
Static pressure range		in.WG	0 to 0.60 (0 to 150)		
Standard static pressure		(Pa)	0.16 (40)		
Sound pressure level	High	dB (A)	36		
	Med		31		
	Low		28		
Dimensions (H × W × D)		in. (mm)	10-5/16 × 44-11/16 × 27-9/16 (270 × 1,135 × 700)		
Weight		lbs. (kg)	86 (39)		
Connection pipe diameter	Liquid (Flare)	in. (mm)	3/8 (9.52)		
	Gas (Flare)		5/8 (15.88)		
Condensate Drain hose diameter (I.D./O.U.)			3/4" / 1-1/16"		

Note : Specifications are based on the following conditions.

Cooling : Indoor temperature of 80°F(26.7°C)DB/67°F(19.4°C)WB,and outdoor temperature of 95.0°F(35°C)DB/75°F(23.9°C)WB.

Heating : Indoor temperature of 70°F(21.1°C)DB/60°F(15.6°C)WB,and outdoor temperature of 47°F(8.3°C)DB/43°F(6.1°C)WB.

Pipe length : 25ft. (7.5 m) , Height difference : 0ft. (0 m) (Outdoor unit - Indoor unit).

Built-in protective functions may limit capacity or shut off unit if unit is operated outside of unit design operating temperature ranges.

Two-direction condensate drain piping

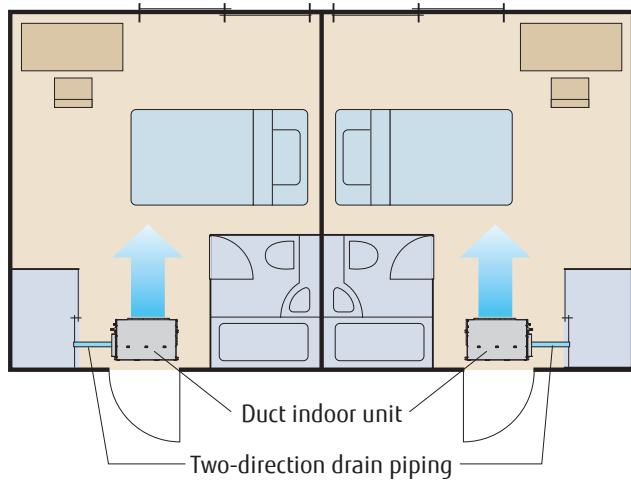

Installation styles

Embedded in Ceiling

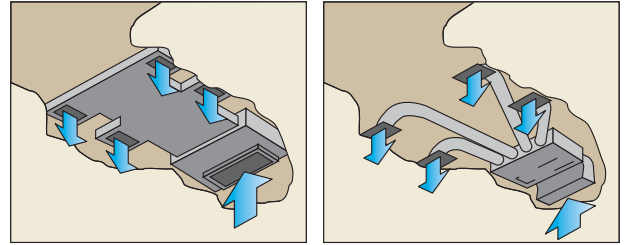

Hanging from Ceiling

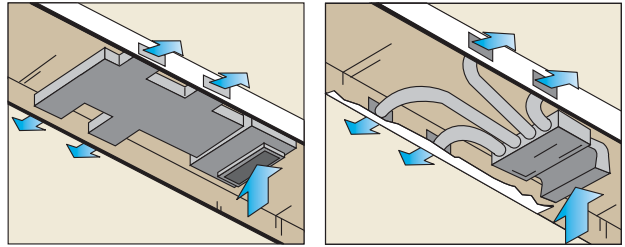

High efficiency DC fan motors

24 model



30/36 model



Optional Accessories

- Drain Pump Unit (Externally mounted)UTZ-PU1NBA
- Long Life Filter* UTD-LF25NA
- Flange (Square) UTD-SF045T
- Flange (Round) UTD-RF204
- IR Receiver UTB-TRHX
- Wireless Remote ControllerUTY-LNHU
- Remote Sensor Unit..... UTY-XSZX

*Note, Medium Static Pressure Duct models do not include a standard filter.

Dimensions

(Unit: In (mm))

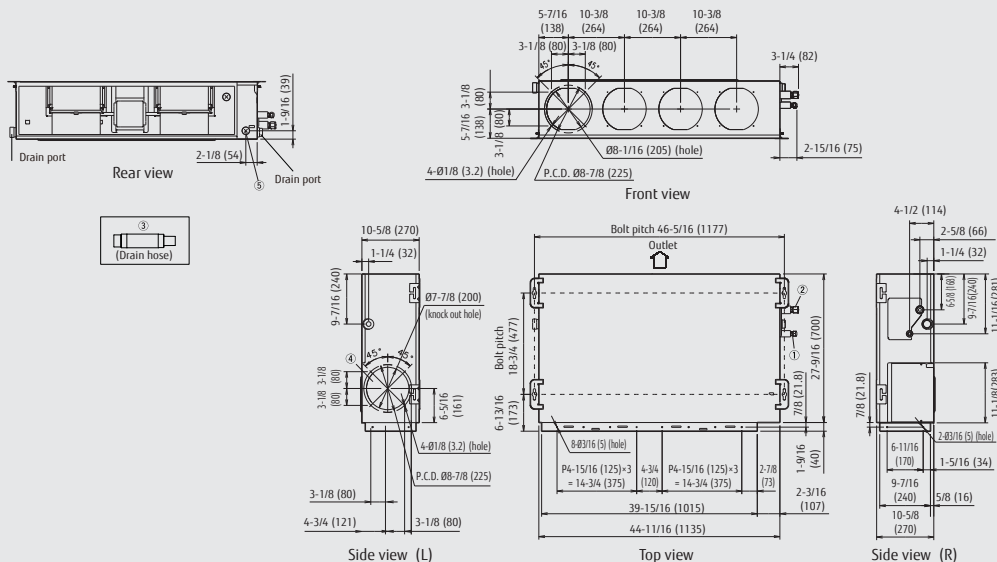

	ARUM 24/30	ARUM 36
① Refrigerant pipe flare connection (Liquid)	ø 3/8 (9.52)	ø 3/8 (9.52)
② Refrigerant pipe flare connection (Gas)	ø 5/8 (15.88)	ø 3/4 (19.05)
③ Drain hose connection (Drain Hose)	ø 3/4 (I.D.), ø 1-1/16 (O.D.)	
④ Knock out hole (fresh air)	7-7/8 (200)	7-7/8 (200)
⑤ Hole for power cable	7/8 (23)	7/8 (23)

High Static Pressure Duct (3, 4, 5 ton)

ARUH36TLAV2

ARUH48TLAV2

ARUH60TLAV2

High Static Pressure Ducted Indoor units with powerful capabilities of up to 1 in. WG external static pressure. Improved ductwork and filtration flexibility with high CFM and ESP capabilities.



Compact size for flexible installation

Comes with secondary drain pan installed and insulated!

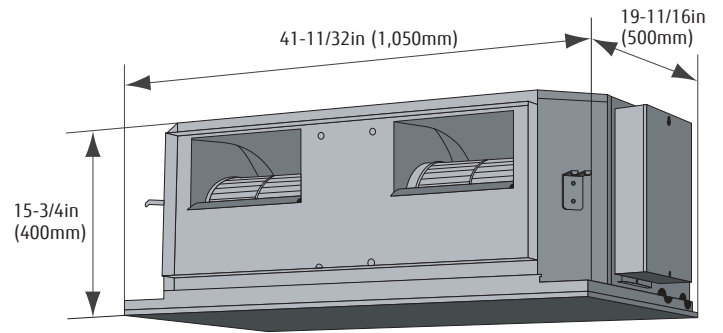

Specifications

Model name			ARUH36TLAV2	ARUH48TLAV2	ARUH60TLAV2
Power source			1 Phase - 208/230V 60Hz		
Capacity	Cooling	BTU/h	36,000	48,000	60,000
		kW	10.6	14.1	17.6
	Heating	BTU/h	40,000	54,000	67,000
		kW	11.7	15.8	19.6
Input power		W	496	752	806
Airflow rate	High	CFM (m ³ /h)	1,324 (2,250)	1,766 (3,000)	1,972 (3,350)
	Med		1,030 (1,750)	1,589 (2,700)	1,678 (2,850)
	Low		824 (1,400)	1,354 (2,300)	1,501 (2,550)
Static pressure range		in.WG	0.40 to 0.80 (100 to 200)	0.40 to 1.00 (100 to 250)	0.40 to 1.00 (100 to 250)
Standard static pressure		(Pa)	0.40 (100)	0.40 (100)	0.40 (100)
Sound pressure level	High	dB (A)	43	47	48
	Med		37	43	44
	Low		32	40	41
Dimensions (H × W × D)		in.(mm)	15-3/4 × 41-5/16 × 19-11/16 (400 × 1,050 × 500)		
Weight		lbs.(kg)	97 (44)	101 (46)	101 (46)
Connection pipe diameter	Liquid (Flare)	in.(mm)	3/8 (9.52)	3/8 (9.52)	3/8 (9.52)
	Gas (Flare)		3/4 (19.05)	3/4 (19.05)	3/4 (19.05)
Condensate Drain hose diameter (I.D./O.U.)			3/4" / 1-1/16"		

Note : Specifications are based on the following conditions.

Cooling : Indoor temperature of 80°F(26.7°C)DB/67°F(19.4°C)WB, and outdoor temperature of 95.0°F(35°C)DB/75°F(23.9°C)WB.

Heating : Indoor temperature of 70°F(21.1°C)DB/60°F(15.6°C)WB, and outdoor temperature of 47°F(8.3°C)DB/43°F(6.1°C)WB.

Pipe length : 25ft. (7.5 m), Height difference : 0ft. (0 m) (Outdoor unit - Indoor unit).

Built-in protective functions may limit capacity or shut off unit if unit is operated outside of unit design operating temperature ranges.

High static pressure design

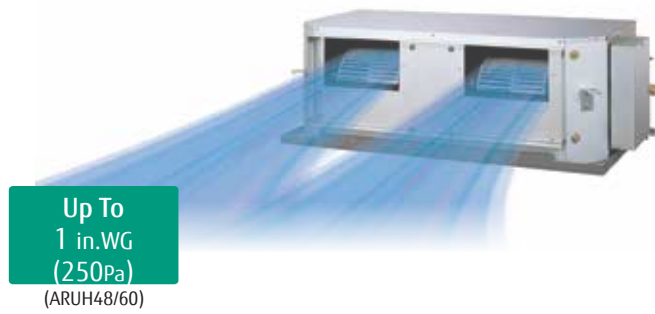

Up To
1 in.WG
(250Pa)
(ARUH48/60)

Quiet operation

Indoor unit

Optimized unit chassis design reduces internal air turbulence and lowers the sound levels.

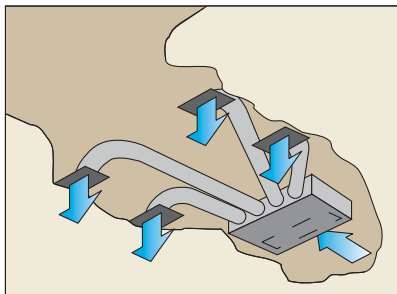
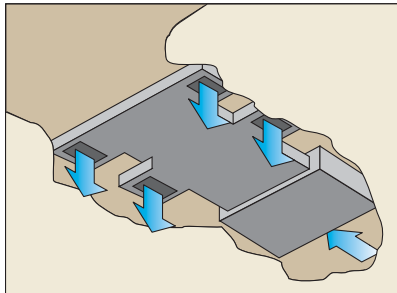
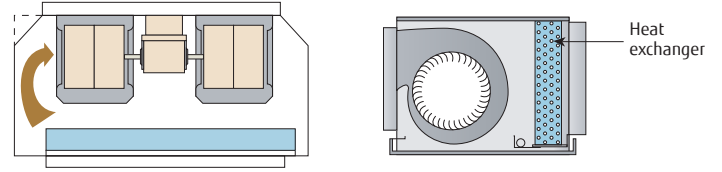

Optional Accessories

- Long-Life Filter* UTD-LF60KA
 - IR Receiver UTB-TRHX
 - Wireless Remote Controller UTY-LNHU
 - Remote Sensor Unit..... UTY-XSZX
- *Note, High Static Pressure Duct models do not include a standard filter.

Integral Mounting Brackets

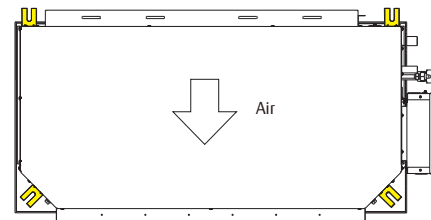

Top view

Dimensions

(Unit: In (mm))

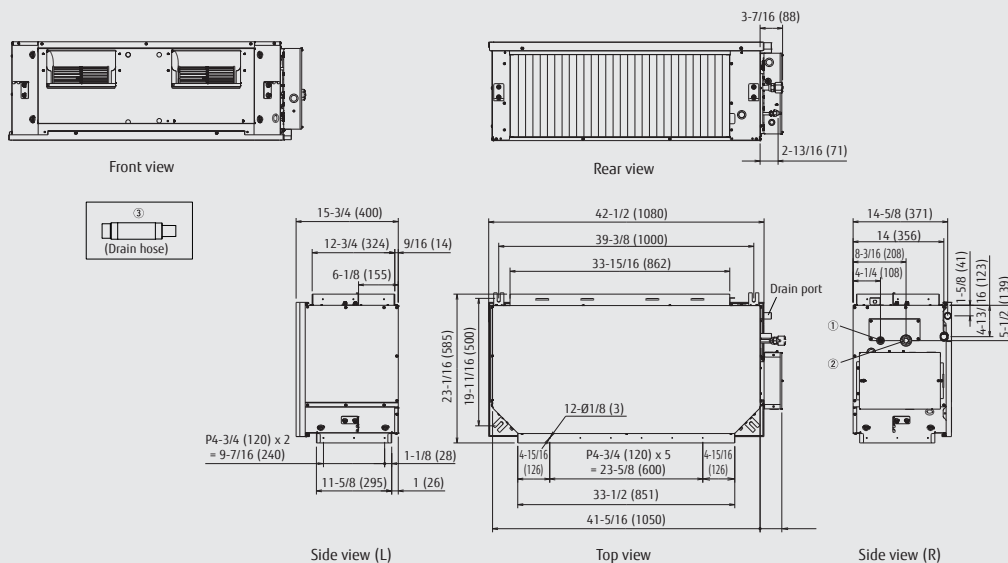

	ARUH 36/48/60
① Refrigerant pipe flare connection (Liquid)	ø 3/8 (9.52)
② Refrigerant pipe flare connection (Gas)	ø 3/4 (19.05)
③ Drain hose connection (Drain Hose)	ø 3/4 (I.D.), ø 1-1/16 (O.D.)

Economizer and filter box options are available through affiliated third party. Ask your local Fujitsu AIRSTAGE distributor for details.

High Static Pressure Duct (6, 8 ton)

ARUH72TLAV2

ARUH96TLAV2

High capacity and High Static Pressure Ducted Indoor units with powerful capabilities of up to 1.2in. WG external static pressure. Improved ductwork and filtration flexibility with high CFM and ESP capabilities.



Comes with secondary drain pan installed and insulated!

Specifications

Model name		ARUH72TLAV2		ARUH96TLAV2	
Power source		1 Phase - 208/230V 60Hz			
Capacity	Cooling	BTU/h	72,000	96,000	
		kW	21.1	28.1	
	Heating	BTU/h	81,000	108,000	
		kW	23.7	31.7	
Input power		W	618	838	
Airflow rate	High	CFM (m ³ /h)	2296 (3900)	2855 (4850)	
	Med		1942 (3300)	2502 (4250)	
	Low		1766 (3000)	2119 (3600)	
Static pressure range		in.WG	0 to 1.2 (0 to 300)		
Standard static pressure		(Pa)	0.6 (150)		
Sound pressure level	High	dB (A)	47	48	
	Med		43	45	
	Low		40	42	
Dimensions (H x W x D)		in.(mm)	17-11/16 x 62-1/2 x 27-9/16 (450 x 1587 x 700)		
Weight		lbs.(kg)	203 (92)		
Connection pipe diameter	Liquid (Flare)	in.(mm)	1/2 (12.70)		
	Gas (Flare)		7/8 (22.22)		
Condensate Drain hose diameter (I.D./O.U.)		3/4" / 1-1/16"			

DC fan motor for energy efficiency and design flexibility

With an adjustable static pressure range up to 1.2 in.WG and efficient DC fan motor, the High Static Pressure ducted indoor units are designed for flexibility and efficiency.

DC fan motor

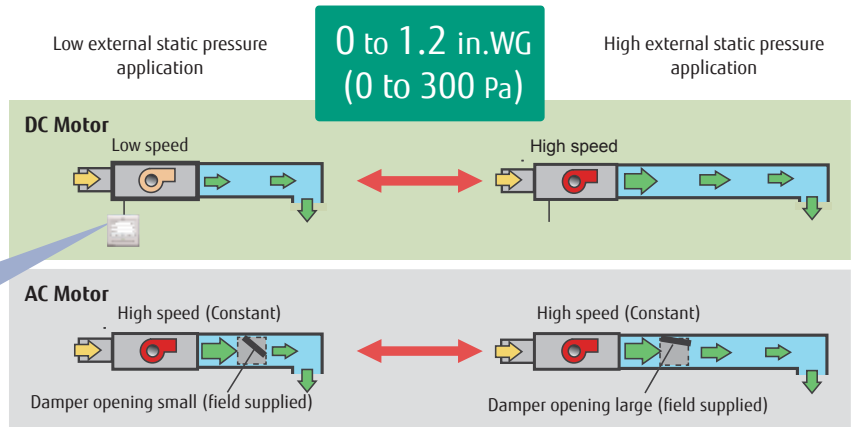

Easy service & maintenance

Each fan motor can be removed individually, if required, for easy service.

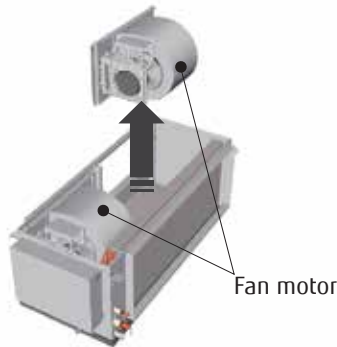

Optional Accessories

- IR Receiver UTB-TRH
- Wireless Remote Controller UTY-LNHU
- Remote Sensor Unit..... UTY-XSZX

Dimensions

(Unit: In (mm))

ARUH72TLAV1

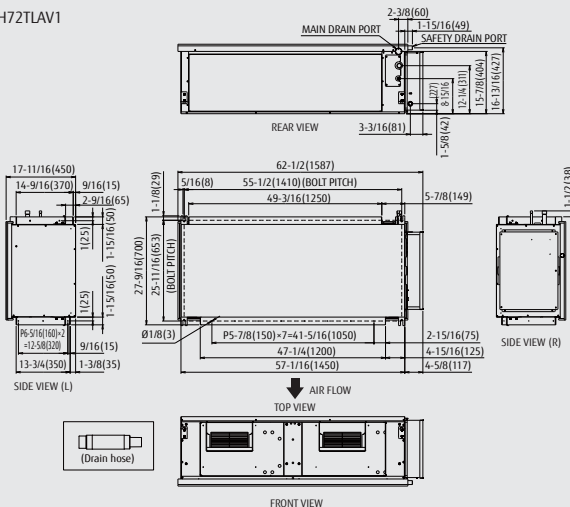

ARUH96TLAV

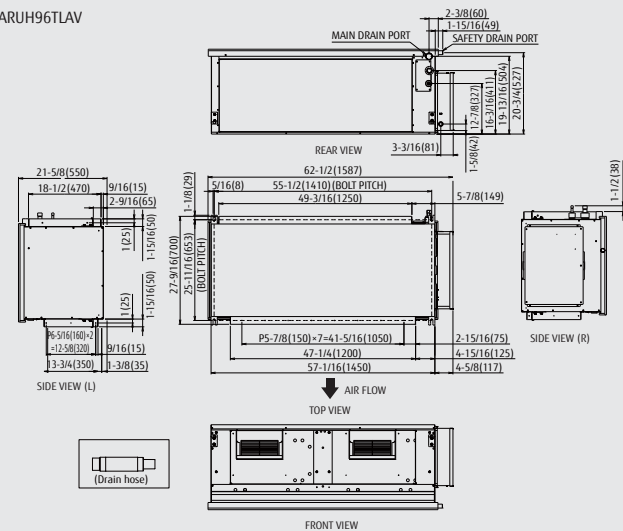

Multi-Position Air Handling Unit

ARUX12TLAV2
 ARUX18TLAV2
 ARUX24TLAV2
 ARUX30TLAV2

ARUX36TLAV2
 ARUX48TLAV2
 ARUX60TLAV2

Static Pressure Range
0.1 to 0.8 in.W.G
 (25 to 200Pa)



ARUX12TLAV2
 ARUX18TLAV2
 ARUX24TLAV2



ARUX30TLAV2
 ARUX36TLAV2



ARUX48TLAV2
 ARUX60TLAV2

Flexible Installation and Wide Static Pressure Range

Flexible and compact design to suit most light commercial and residential applications. At 43" tall and only 17-1/2" wide for up to 2 tons, the unit can be installed in tight closet spaces.

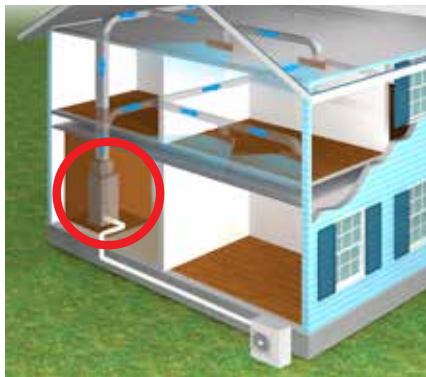

UP FLOW
 Installed in basement or in a narrow closet, distributing conditioned air to the rooms.

Optimum Temperature Control Using Backup Heater (Optional)

Control operation of auxiliary heaters depending on the difference between room temperature and set temperature to maintain optimum comfort. Order heater kits from your local Fujitsu distributor. See table below for sizing.



HORIZONTAL LEFT / RIGHT AIRFLOW
 Installed horizontally in the attic, with overhead distribution of conditioned air to the rooms.

Dimensions

	ARUX12-18-24TLAV2	ARUX30-36TLAV2	ARUX48-60TLAV2
Height	43 in. (1,092 mm)	48 in. (1,219 mm)	58.75 in. (1,492 mm)
Width	17.5 in. (444 mm)	21 in. (533 mm)	24.5 in. (622 mm)
Depth	21 in. (533 mm)	21 in. (533 mm)	21.75 in. (553 mm)

(Unit: In (mm))

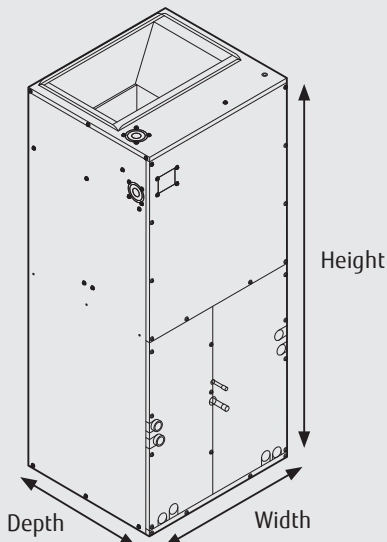

Ton	Indoor unit	Heater model name	VOLTS	KW	Heater AMPS	Minimum circuit ampacity	Maximum fuse or HACR circuit breaker
1	ARUX12TLAV2	UTZ-EU02MSA	240	2	8.33	10.5	15
		UTZ-EU04MSA2	240	4	8.4/8.4	10.5	15/15 *
1.5	ARUX18TLAV2	UTZ-EU03MSA	240	3	12.5	15.7	20
		UTZ-EU06MSA2	240	6	12.5/12.5	15.7/15.7	20/20 *
2	ARUX24TLAV2	UTZ-EU02MSA	240	2	8.4	10.5	15
		UTZ-EU04MSA	240	4	16.7	20.9	25
		UTZ-EU08MSA2	240	8	16.7/16.7	20.9/20.9	25/25 *
2.5	ARUX30TLAV2	UTZ-EU03MMA	240	3	12.5	15.7	20
		UTZ-EU05MMA	240	5	20.9	26.1	30
		UTZ-EU10MMA2	240	10	20.9/20.9	26.1/26.1	30/30
3	ARUX36TLAV2	UTZ-EU03MMA	240	3	12.5	15.7	20
		UTZ-EU06MMA	240	6	25.0	31.3	35
		UTZ-EU12MMA2	240	12	25.0/25.0	31.3/31.3	40/40
4	ARUX48TLAV2	UTZ-EU05MLA	240	5	20.9	26.1	30
		UTZ-EU08MLA	240	8	33.4	41.7	45
5	ARUX60TLAV2	UTZ-EU16MLA2	240	16	33.4/33.4	41.7/41.7	45/45
		UTZ-EU05MLA	240	5	20.9	26.1	30
		UTZ-EU10MLA	240	10	41.7	52.1	60
		UTZ-EU20MLA2	240	20	41.7/41.7	52.1/52.1	60/60

* Locally purchased

Options

Compatible with a variety of controller options, such as individual controller, central controller and building management controller.

Kagami Wired Remote Control	UTY-RVRU	BACnet® Gateway	FUJ-VRF-8025/8125 (AIM)
Wired Remote Controller	UTY-RNRU25		UTY-VBGX (Hardware)
Simple Remote Controller	UTY-RHRY		UTY-ABGXZ1 (Software)
Wireless Remote Controller / IR Receiver	UTY-LNHU / UTY-TRHX	External Power Supply Unit	UTZ-GXXA
Wireless LAN Adapter	UTY-TFSXJ4	Thermostat Converter	UTY-TTRXZ1 / TTRXZ1-KIT
External Switch Controller	UTY-TERX	Network Converter	UTY-VTGX (DC power supply)
AIRSTAGE Edge Controller	UTY-DSGYZ2		UTY-VGGXZ1 (AC power supply)
Central Remote Controller	UTY-DCGYZ2	Highrise 360 Kit	UTY-SPWX
System Controller	UTY-APGXZ1	Network Converter for LONWORKS®	UTY-VLGX
System Controller Lite	UTY-ALGXZ1	Signal Amplifier	UTY-VSGXZ1
Service Tool	UTY-ASGXZ1-KIT	External Connect Kit	UTY-XWZXZB / UTY-XWZXZD
Web Monitoring Tool	UTY-AMGXZ1		UTY-XWZXZ7 / UTY-XWZXZE
Remote Sensor Unit	UTY-XSZX		UTY-XWZXZC / UTY-XWZXZK
MODBUS Converter	UTY-VMSX / UTY-VMGX		

Specifications

Model name			ARUX12TLAV2	ARUX18TLAV2	ARUX24TLAV2	ARUX30TLAV2	ARUX36TLAV2	ARUX48TLAV2	ARUX60TLAV2		
Power supply			1 phase ~ 208/230 V 60 Hz								
Available voltage range			187-253 V								
Capacity	Cooling	Btu/h	12,000	18,000	24,000	30,000	36,000	48,000	60,000		
		kW	3.5	5.3	7.0	8.8	10.6	14.1	17.6		
	Heating	Btu/h	13,500	20,000	27,000	34,000	40,000	54,000	67,000		
		kW	4.0	5.9	7.9	10.0	11.7	15.8	19.6		
Input power			W	77	99	148	180	241	322	521	
Static pressure range			inWG (Pa)	0.10 to 0.80 (25 to 200)							
Standard static pressure			inWG (Pa)	0.50 (125)							
Fan	Airflow rate	HIGH	CFM (m3/h)	350 (595)	500 (850)	650 (1,104)	880 (1,495)	1,050 (1,784)	1,400 (2,379)	1,700 (2,888)	
		MED	320 (544)	450 (765)	590 (1,002)	800 (1,359)	950 (1,614)	1,260 (2,141)	1,550 (2,633)		
		LOW	290 (493)	400 (680)	510 (866)	730 (1,240)	850 (1,444)	1,130 (1,920)	1,340 (2,277)		
	Type × Q'ty	Sirocco × 1									
Motor output			W	249			373		560		
Sound pressure level*	dB (A)	HIGH	37	38	40	42	44	46	48		
		MED	35	36	37	40	42	44	46		
		LOW	33	34	34	38	40	42	42		
Heat exchanger type	Length	in (mm)	16 (406)	16 (406)	16 (406)	16 (406)	16 (406)	17-1/2 (446)	17-1/2 (446)		
	Fin pitch	FPI	16	16	16	14	14	14	14		
	Rows × Stages		4 × 14	2 × 18	2 × 18	3 × 22	3 × 22	3 × 30	4 × 30		
	Face area	ft2 (m2)	2.6 (0.24)	3.3(0.31)	3.3(0.31)	4.0 (0.38)	4.0 (0.38)	6.0 (0.56)	6.0 (0.56)		
	Pipe type (Material)	Grooved H-pin (Copper)									
	Fin	Type (Material)	Louver (Aluminum)								
		Surface treatment	Louver (Aluminum)								
Enclosure	Material	Painted galvanized steel sheet									
	Color	Gray									
Dimensions (H × W × D)	Net	in (mm)	43 × 17-1/2 × 21 (1,092 × 444 × 533)			48 × 21 × 21 (1,219 × 533 × 533)		58-3/4 × 24-1/2 × 21-3/4 (1,492 × 622 × 552)			
	Gross		45 × 19-3/4 × 26-3/4 (1,143 × 502 × 679)			52 × 23 × 26-3/4 (1,321 × 584 × 679)		63 × 27 × 27-1/2 (1600 × 686 × 699)			
Weight	Net	lb (kg)	100 (45.4)	102 (46.3)	102 (46.3)	126 (57.2)	126 (57.2)	172 (78.0)	181 (82.1)		
	Gross		111 (50.3)	113 (51.3)	113 (51.3)	139 (63.0)	139 (63.0)	187 (84.8)	196 (88.9)		
Connection pipe diameter	Liquid	in (mm)	Ø 1/4 (6.35)	Ø 1/4 (6.35)	Ø 1/4 (6.35)	Ø 3/8 (9.52)	Ø 3/8 (9.52)	Ø 3/8 (9.52)	Ø 3/8 (9.52)		
	Gas		Ø 1/2 (12.70)	Ø 1/2 (12.70)	Ø 1/2 (12.70)	Ø 5/8 (15.88)	Ø 5/8 (15.88)	Ø 5/8 (15.88)	Ø 5/8 (15.88)		
	Connection method	Brazing									
Drain hose	in (mm)	I.D.: Ø 3/4 (19.05)									

NOTES:

Specifications are based on the following conditions:

- Cooling: Indoor temperature of 80 °FDB/67 °FWB (26.7 °CDB/19.4 °CWB), and outdoor temperature of 95 °FDB/75 °FWB (35 °CDB/23.9 °CWB).
- Heating: Indoor temperature of 70 °FDB/60 °FWB (21.1 °CDB/15.6 °CWB), and outdoor temperature of 47 °FDB/43 °FWB (8.3 °CDB/6.1 °CWB).
- Pipe length: 25 ft (7.5 m), Height difference: 0 ft (0 m). (Between outdoor unit and indoor unit.)

Protective function might work when using it outside the operation range.

*: Sound pressure level:

- Measured values in manufacturer's anechoic chamber.
- Because of the surrounding sound environment, the sound levels measured in actual installation conditions might be higher than the specified values here.

Actual product color may be different from the colors shown here. Specifications and design are subject to change without notice.

"AIRSTAGE" is a worldwide trademark of FUJITSU GENERAL LIMITED and is a registered trademark in Japan and other countries or areas.

Floor Mount

AGUA4TLAV2

AGUA7TLAV2

AGUA9TLAV2

AGUA12TLAV2

AGUA14TLAV2



Dual Fans and Wide Airflow

Individual vertical airflow by 2 fans for optimized air distribution and comfort in the entire room.

Cooling

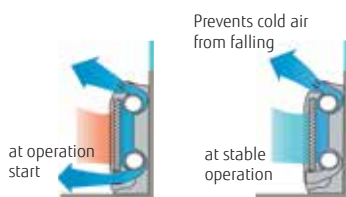

Heating

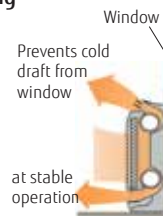

Flexible Piping Connection

Flexible installation with 6 positions for condensate drain hose and piping to choose from: right, left, side and down positions.

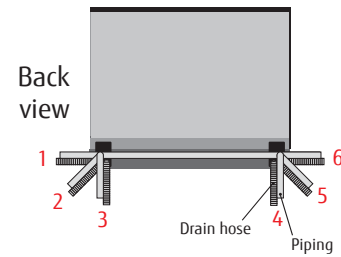

Specifications

Model name			AGUA4TLAV2	AGUA7TLAV2	AGUA9TLAV2	AGUA12TLAV2	AGUA14TLAV2
Power Source			1 Phase - 208 / 230V ~ 60Hz				
Capacity	Cooling	BTU/h	4,000	7,500	9,500	12,000	14,000
		kW	1.2	2.2	2.8	3.5	4.1
	Heating	BTU/h	4,400	9,500	10,900	13,500	15,600
		kW	1.3	2.8	3.2	4.0	4.6
Input Power		W	12 / 14	16	17	22	29
Max. Operating Current		A	0.19 / 0.22	0.24	0.25	0.30	0.38
Airflow rate	High	CFM (m ³ /h)	224 (380) / 253 (430)*	277 (470)	294 (500)	347 (590)	394 (670)
	Med-Hi		206 (350)	247 (420)	265 (450)	306 (520)	347 (590)
	Med		188 (320)	230 (390)	235 (400)	277 (470)	306 (520)
	Lo-Hi		182 (310)	212 (360)	212 (360)	247 (420)	265 (450)
	Low		165 (280)	194 (330)	194 (330)	230 (390)	230 (390)
	Quiet		124 (210)	159 (270)	159 (270)	200 (340)	200 (340)
Sound pressure level	High	dB(A)	35/36*	37	38	42	46
	Med-Hi		33	35	36	39	42
	Med		31	33	34	37	39
	Lo-Hi		30	31	31	35	36
	Low		28	29	29	33	33
	Quiet		22	22	22	30	30
Dimensions (H x W x D)		in.(mm)	23-5/8 x 29-1/8 x 7-7/8 (600 x 740 x 200)				
Weight		lbs.(kg)	33 (15)	33 (15)	33 (15)	33 (15)	33 (15)
Connection pipe diameter	Liquid (Flare)	in.(mm)	1/4 (6.35)	1/4 (6.35)	1/4 (6.35)	1/4 (6.35)	1/4 (6.35)
	Gas (Flare)		3/8 (9.52)	3/8 (9.52)	3/8 (9.52)	1/2 (12.70)	1/2 (12.70)
Condensate Drain hose diameter (I.D./O.D.)		in.	9/16 / 5/8 to 11/16				

Note: Specifications are based on the following conditions: Built-in protective functions may limit capacity or shut off unit if unit is operated outside of unit design operating temperature ranges. Cooling: Indoor temperature of 80°F(26.7°C)DB/67°F(19.4°C)WB; and outdoor temperature of 95°F(35°C)DB/75°F(23.9°C)WB. Heating: Indoor temperature of 70°F(21.1°C)DB/60°F(15.6°C)WB, and outdoor temperature of 47°F(8.3°C)DB/43°F(6.1°C)WB. Pipe Length : 25ft. (7.5m), Height difference : 0ft.(0m) (Outdoor unit - indoor unit).

*Cooling operation / heating operation.

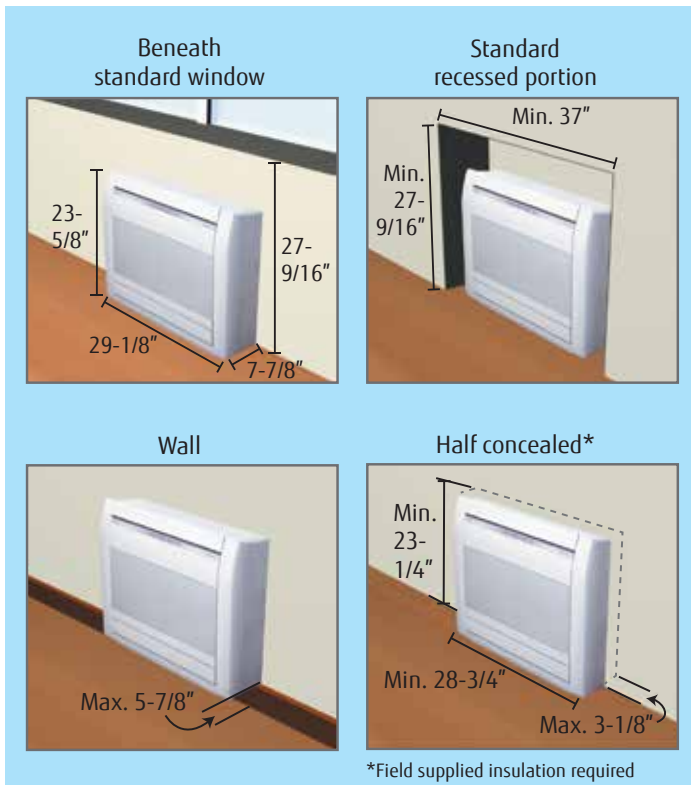

Quiet Operation

With 6 fan speeds to choose from, floor mounted models operate as quietly as 22 dB(A).



6-Step Speed

High

Med-Hi

Med

Lo-Hi

Low

Quiet



Flexible and Easy Installation

At less than 24" high and 30" wide, floor mount models fit easily under a standard window and can replace a traditional radiator twice its size while producing more capacity.

Optional Accessories

Kagami Wired Remote Control.....	UTY-RVRU
Wired Remote Controller	UTY-RNRUZ*
Simple Remote Controller	UTY-RSRY, UTY-RHRY
Wireless Remote Controller.....	UTY-LNHU
Half Concealed Kit	UTR-STA

Dimensions

(Unit: In (mm))

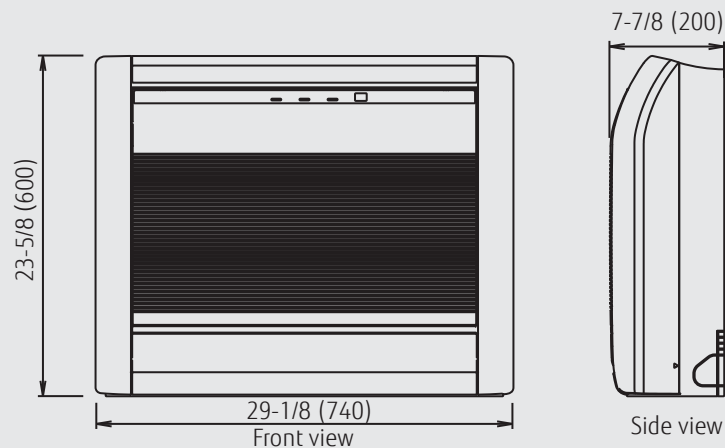

Floor / Ceiling

- ABUA12TLAV2
- ABUA14TLAV2
- ABUA18TLAV2
- ABUA24TLAV2



The slim and lightweight design allows the unit to be suspended horizontally from the ceiling or installed vertically on the floor, offering flexibility in design and installation.

Note: IR Receiver is standard for communicating with optional Wireless Remote Control.

Flexible installation

Example of floor installation



Example of ceiling installation



Specifications

Model name		ABUA12TLAV2	ABUA14TLAV2	ABUA18TLAV2	ABUA24TLAV2	
Power source		1 Phase ~ 208/230V 60Hz				
Capacity	Cooling	BTU/h	12,000	14,000	18,000	24,000
		kW	3.5	4.1	5.3	7.0
	Heating	BTU/h	13,500	15,600	20,000	27,000
		kW	4.0	4.6	5.9	7.9
Input power		W	30	42	74	99
Airflow rate	High	CFM (m ³ /h)	388 (660)	459 (780)	589 (1,000)	589 (1,000)
	Med		336 (570)	377 (640)	424 (720)	483 (820)
	Low		288 (490)	324 (550)	341 (580)	400 (680)
Sound pressure level	High	dB (A)	36	40	46	47
	Med		32	36	39	42
	Low		28	34	35	37
Dimensions (H × W × D)		in.(mm)	7-13/16 × 39 × 25-13/16 (199 × 990 × 655)			
Weight		lbs.(kg)	56 (25)	57 (26)	57 (26)	60 (27)
Connection pipe diameter	Liquid (Flare)	in.(mm)	1/4 (6.35)	1/4 (6.35)	3/8 (9.52)	3/8 (9.52)
	Gas (Flare)		1/2 (12.70)	1/2 (12.70)	5/8 (15.88)	5/8 (15.88)
Condensate Drain hose diameter (I.D./O.U.)		3/4" / 1-1/16"				

Note : Specifications are based on the following conditions.

Cooling : Indoor temperature of 80°F(26.7°C)DB/67°F(19.4°C)WB,and outdoor temperature of 95.0°F(35°C)DB/75°F(23.9°C)WB.

Heating : Indoor temperature of 70°F(21.1°C)DB/60°F(15.6°C)WB,and outdoor temperature of 47°F(8.3°C)DB/43°F(6.1°C)WB.

Pipe length : 25ft.(7.5 m), Height difference : 0ft.(0 m) (Outdoor unit - Indoor unit).

Built-in protective functions may limit capacity or shut off unit if unit is operated outside of unit design operating temperature ranges.

Flexible four-way louver swing

Combination of up/down and right/left directional louver swing provides excellent air distribution especially in large spaces.

RIGHT and LEFT SWING

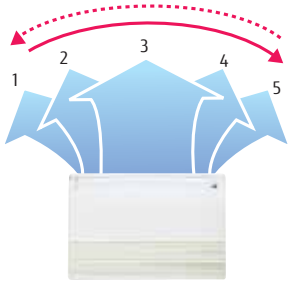

UP and DOWN SWING

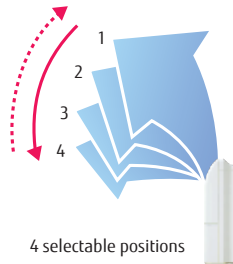

Efficient and powerful DC fan motor



Auto-closing louver

When operation is stopped, the louvers will automatically close.

Compact design

Symmetric, slim and compact design.

Unit : in (mm)

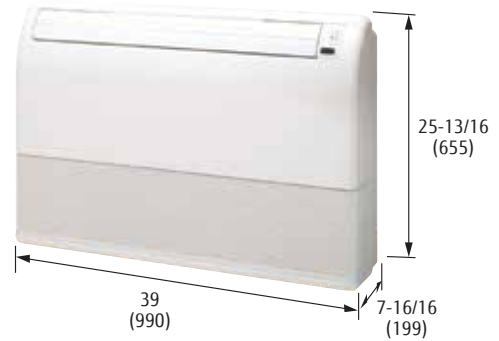

Optional Accessories

Wireless Remote Controller.....UTY-LNHU

Dimensions

(Unit: In (mm))

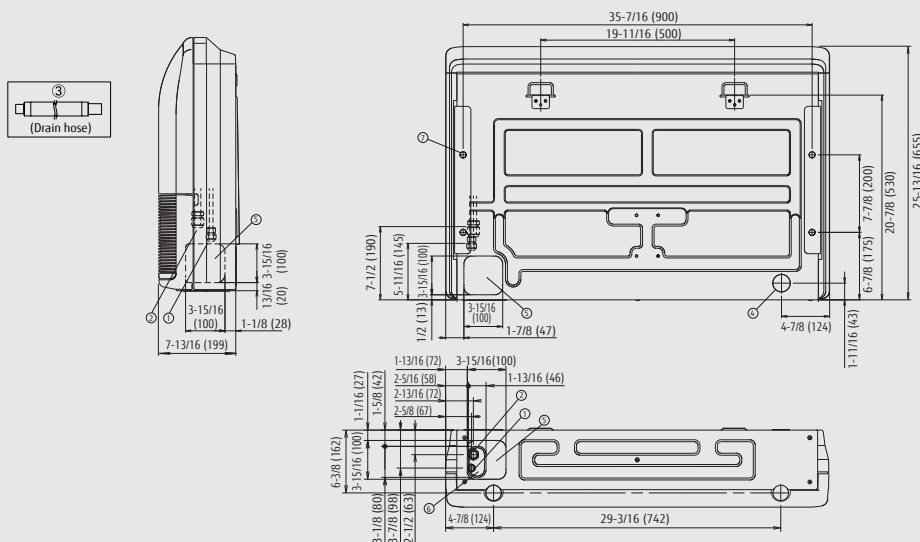

	ABUA 12/14	ABUA 18/24
① Refrigerant pipe flare connection (Liquid)	ø 1/4 (6.35)	ø 3/8 (9.52)
② Refrigerant pipe flare connection (Gas)	ø 1/2 (12.70)	ø 5/8 (15.88)
③ Drain hose connection (Drain Hose)	ø 3/4 (I.D.), ø 1-1/16 (O.D.)	
④ Knock out hole (Drain Outlet)	ø 1-3/4 (45)	ø 1-3/4 (45)
⑤ Knock out hole	—	—
⑦ Hole for lifting bolt	Use M10 screw bolt	

Ceiling

ABUA30TLAV2
ABUA36TLAV2



Slim and elegant design makes the ceiling-suspended indoor unit a great fit for any light commercial applications such as retail stores, restaurants, conference rooms. Optimized air openings provide a comfortable air flow and low sound levels.

Note: IR Receiver is standard for communicating with optional Wireless Remote Control.

Installation

Open

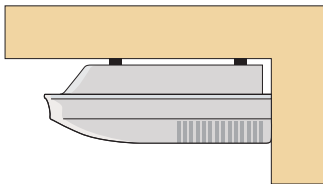

Standard installation with unit suspended from the ceiling.

Concealed

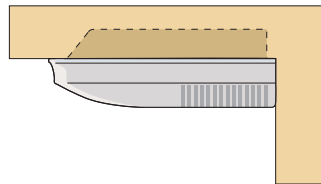

Partially recessed installation.

Wall mounted

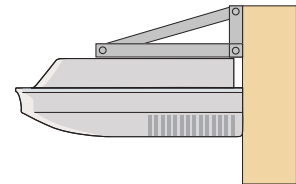

Efficient air distribution with long throw ensures comfort even in large rooms.

Slim & Compact design

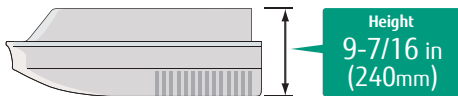

Efficient and powerful DC fan motor



Specifications

Model name		ABUA30TLAV2		ABUA36TLAV2	
Power source		1 Phase - 208/230V 60Hz			
Capacity	Cooling	BTU/h	30,000	36,000	
		kW	8.8	10.6	
	Heating	BTU/h	34,000	40,000	
		kW	10.0	11.7	
Input power		W	85	85	
Airflow rate	High	CFM (m ³ /h)	859 (1,630)	995 (1,690)	
	Med		806 (1,370)	824 (1,400)	
	Low		671 (1,140)	689 (1,170)	
Sound pressure level	High	dB (A)	42	45	
	Med		38	38	
	Low		33	34	
Dimensions (H x W x D)		in.(mm)	9-7/16 x 65-3/8 x 27-9/16 (240 x 1,660 x 700)		
Weight		lbs.(kg)	101 (46)	106 (48)	
Connection pipe diameter	Liquid (Flare)		3/8 (9.52)	3/8 (9.52)	
	Gas (Flare)	in.(mm)	5/8 (15.88)	3/4 (19.05)	
Condensate Drain hose diameter (I.D./O.U.)			3/4" / 1-1/16"		

Note : Specifications are based on the following conditions.

Cooling : Indoor temperature of 80°F (26.7°C) DB/67°F (19.4°C) WB, and outdoor temperature of 95.0°F (35°C) DB/75°F (23.9°C) WB.

Heating : Indoor temperature of 70°F (21.1°C) DB/60°F (15.6°C) WB, and outdoor temperature of 47°F (8.3°C) DB/43°F (6.1°C) WB.

Pipe length : 25ft. (7.5 m), Height difference : 0ft. (0 m) (Outdoor unit - Indoor unit).

Built-in protective functions may limit capacity or shut off unit if unit is operated outside of unit design operating temperature ranges.

Four-way louver swing

Auto airflow direction and auto swing
Right and left

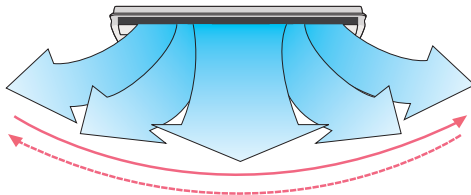

5 selectable positions

Up and down

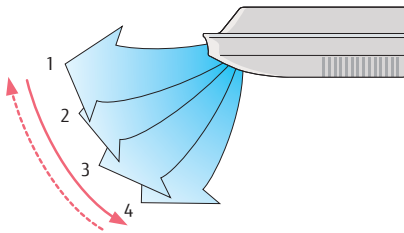

4 selectable positions

Efficient air distribution

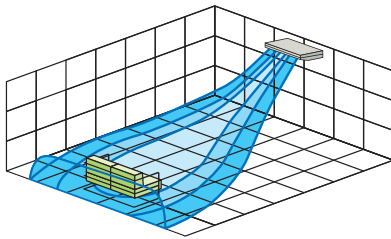

Condensate drain pump (Optional)

Installation flexibility with optional condensate drain pump.

Height
19-11/16 in
(500mm)

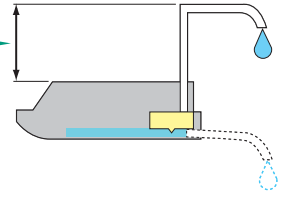

Outside air intake

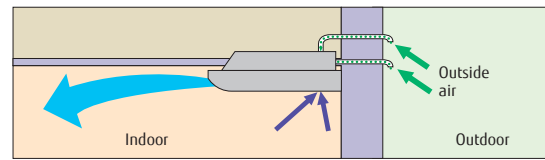

Air filter

High Efficiency long-life filter can double the life of the filter compared to standard filters.

Optional Accessories

Wireless Remote Control.....UTY-LNHU
Drain Pump Unit.....UTZ-PU1EBA / UTR-DPB24T
Flange.....UTD-RF204

Dimensions

(Unit: In (mm))

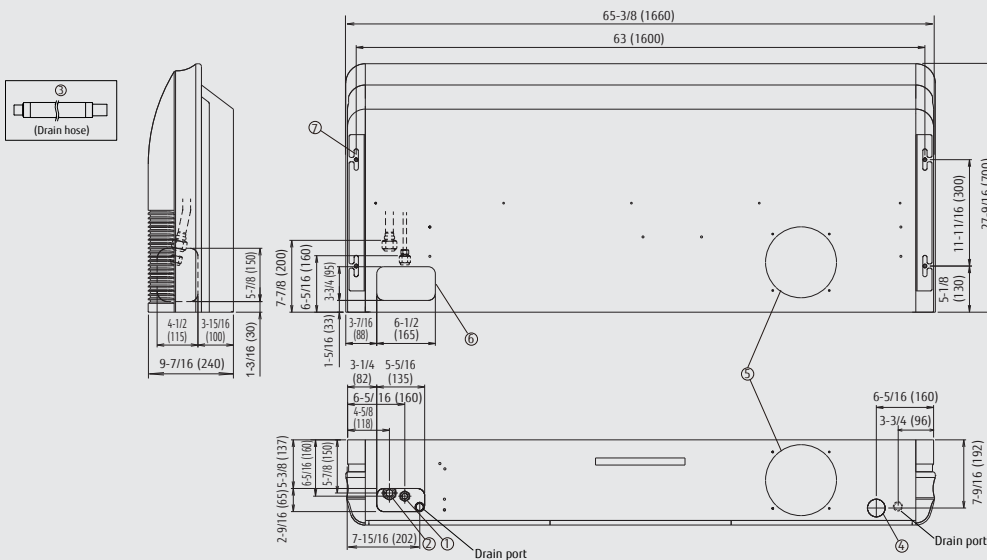

	ABUA 30	ABUA 36
① Refrigerant pipe flare connection (Liquid)	ø 3/8 (9.52)	ø 3/8 (9.52)
② Refrigerant pipe flare connection (Gas)	ø 5/8 (15.88)	ø 3/4 (19.05)
③ Drain hose connection (Drain Hose)	ø 3/4 (I.D.), ø 1-1/16 (O.D.)	ø 3/4 (I.D.), ø 1-1/16 (O.D.)
④ Knock out hole (Drain Outlet)	ø 1-15/16 (50)	ø 1-15/16 (50)
⑤ Knock out hole (Outside Air)	ø 7-7/8 (200)	ø 7-7/8 (200)
⑥ Knock out hole (Refrigerant Pipe)	—	—
⑦ Hole for lifting bolt	Use M10 screw bolt	

Compact Wall Mounted

- ASUA4TLAV2
- ASUA7TLVA2
- ASUA9TLAV2
- ASUA12TLVA2
- ASUA14TLAV2



4/7/9,000 BTU/h



12/14,000 BTU/h

Easy Installation

Wiring can be easily connected by opening the front panel and wire cover.

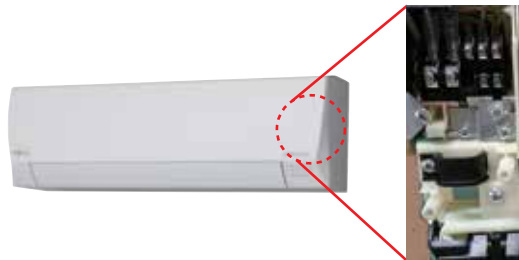

High density heat exchanger

Increased heat transfer efficiency with thin tube technology.

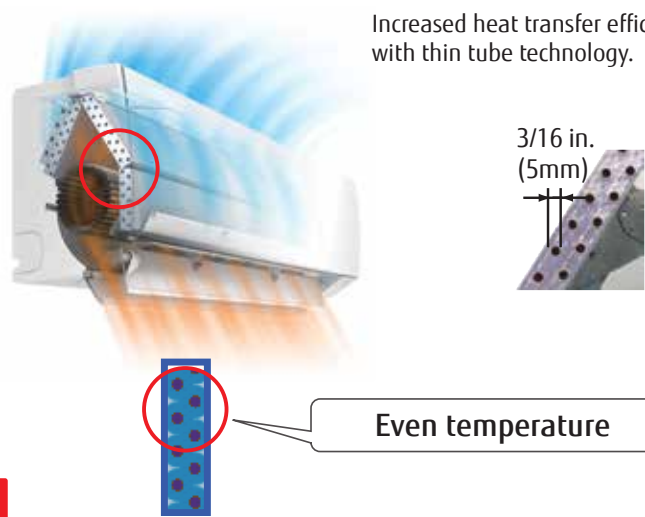

Quiet operation

Improved airflow pattern reduces noise significantly.

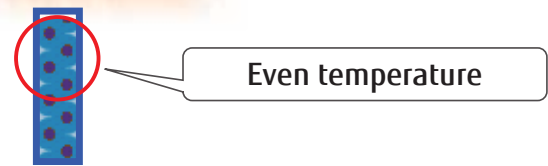
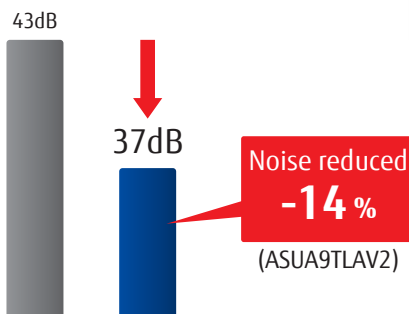

Specifications

Model name		ASUA4TLAV2	ASUA7TLVA2	ASUA9TLAV2	ASUA12TLVA2	ASUA14TLAV2	
Power Source		1 Phase - 208 / 230V ~ 60Hz					
Capacity	Cooling	BTU/h	4,000	7,500	9,500	12,000	14,000
		kW	1.2	2.2	2.8	3.5	4.2
Capacity	Heating	BTU/h	4,400	9,500	10,900	13,500	15,600
		kW	1.3	2.8	3.2	4.0	4.6
Input Power		W	13	19	34	25	36
Airflow rate	High	CFM (m ³ /h)	253 (430)	324 (550)	424 (720)	406 (690)	471 (800)
	Med-Hi		247 (420)	271 (460)	336 (570)	359 (610)	436 (740)
	Med		230 (390)	247 (420)	294 (500)	330 (560)	400 (680)
	Lo-Hi		224 (380)	230 (390)	241 (410)	312 (530)	359 (610)
	Low		212 (360)	212 (360)	212 (360)	277 (470)	324 (550)
	Quiet		194 (330)	194 (330)	194 (330)	194 (330)	194 (330)
Sound pressure level	High	dB(A)	31	35	43	40	44
	Med-Hi		30	32	38	37	42
	Med		28	30	34	35	40
	Lo-Hi		26	27	29	33	37
	Low		24	24	24	30	34
	Quiet		22	22	22	24	24
Dimensions (H x W x D)		in. (mm)	10-5/16 x 32-5/16 x 8-1/8 (262 x 820 x 206)			10-9/16 x 33-1/16 x 8 (268 x 840 x 203)	
Weight		lbs. (kg)	17 (7.5)	17 (7.5)	17 (7.5)	20 (9)	20 (9)
Connection pipe diameter	Liquid (Flare)	in. (mm)	Ø1/4 (6.35)	1/4 (6.35)	1/4 (6.35)	1/4 (6.35)	1/4 (6.35)
	Gas (Flare)		Ø3/8 (9.52)	3/8 (9.52)	3/8 (9.52)	1/2 (12.70)	1/2 (12.70)
Condensate Drain hose diameter (I.D./O.D.) in.			9/16 / 5/8 to 11/16				

Note : Specifications are based on the following conditions: Built-in protective functions may limit capacity or shut off unit if unit is operated outside of unit design operating temperature ranges.

Cooling : Indoor temperature of 80°F(26.7°C)DB/67°F(19.4°C)WB; and outdoor temperature of 95°F(35°C)DB/75°F(23.9°C)WB. Heating : Indoor temperature of 70°F(21.1°C)DB/60°F(15.6°C)WB, and outdoor temperature of 47°F(8.3°C)DB/43°F(6.1°C)WB. Pipe Length : 25ft. (7.5m), Height difference : 0ft.(0m)(Outdoor unit - indoor unit).

*Cooling / Heating

6-speed fan control (ASUA4TLAV2 only)

With 6 fan speeds to choose from, these wall mounted models operate as quietly as 22 dB(A).

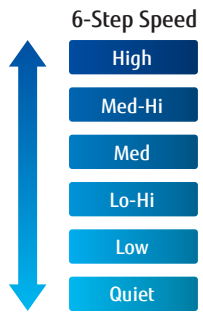

Six-speed fan control available through the following Remotes and Controllers:
 UTY-RVRU / UTY-RNRUZ* / UTY-RSRY / UTY-RHRY / UTY-DSGYZ2 / UTY-DCGYZ2 / UTY-ALGXZ1 / UTY-APGXZ1

Comfortable airflow

Models ASUA12/14TLAV2
UNIQUE POWER DIFFUSER

Heating

Vertical airflow provides powerful floor level heating

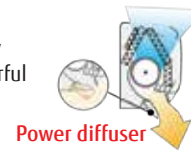

Cooling

Horizontal airflow does not supply cool air directly at the occupants in the room.



Occupancy / Human sensor function

Models ASUA12/14TLAV2

The energy saving occupancy function can, via the optional Wired Remote Controller, be set to turn off the unit or change to power saving mode when a room becomes unoccupied.



Human sensor

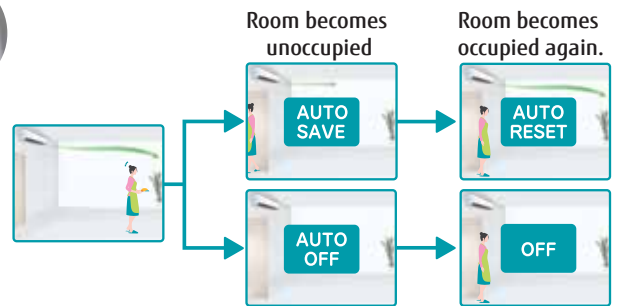

Powerful airflow

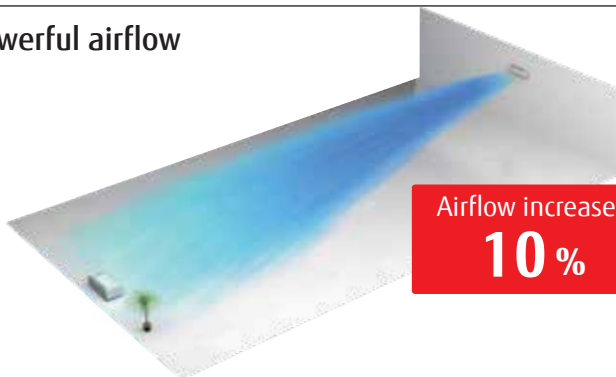

Optional Accessories

- Kagami Wired Remote Control UTY-RVRU
- Wired Remote Control (Touch Panel):.....UTY-RNRUZ*
- Simple Remote Control:..... UTY-RSRY, UTY-RHRY
- Wireless Remote Control:..... UTY-LNHU

Dimensions

Models:

ASUA4TLAV2 / ASUA7TLAV2 / ASUA9TLAV2

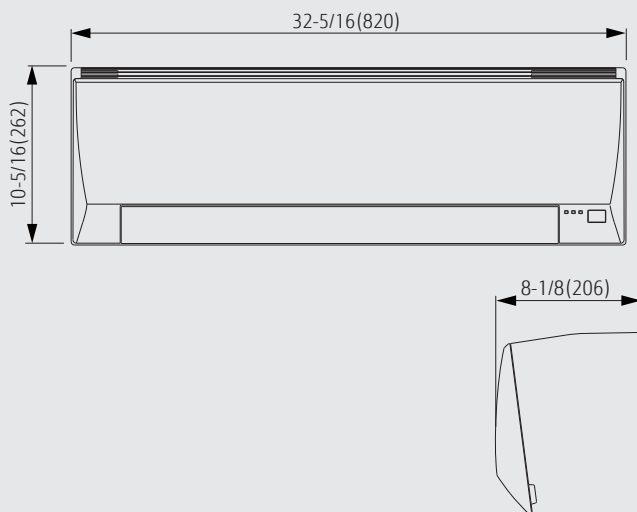

(Unit: In (mm))

Models:

ASUA12TLAV2/ASUA14TLAV2

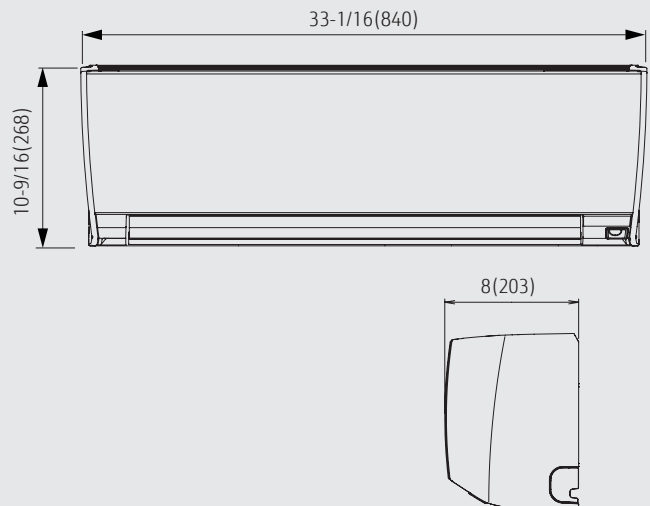

Wall Mounted

- ASUB18TLAV2
- ASUB24TLAV2
- ASUA30TLAV2
- ASUA36TLAV2



18/24,000 BTU/h



30/36,000 BTU/h

Comfortable air distribution

Power diffuser
(ASUB18/24TLAV2)

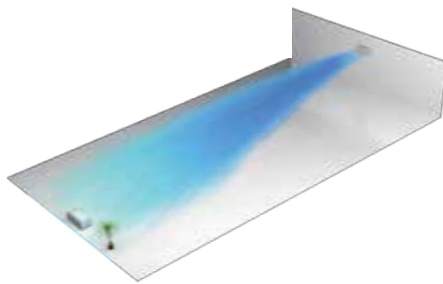
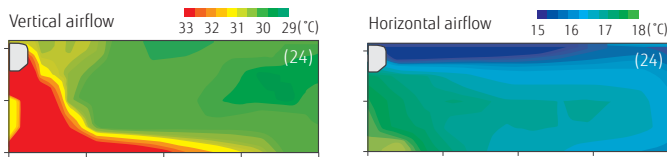

Occupancy / Human sensor setting

Models ASUB30/36TLAV2 only

The energy saving occupancy function can, via the optional Wired Remote Controller, be set to turn off the unit or change to power saving mode when a room becomes unoccupied.

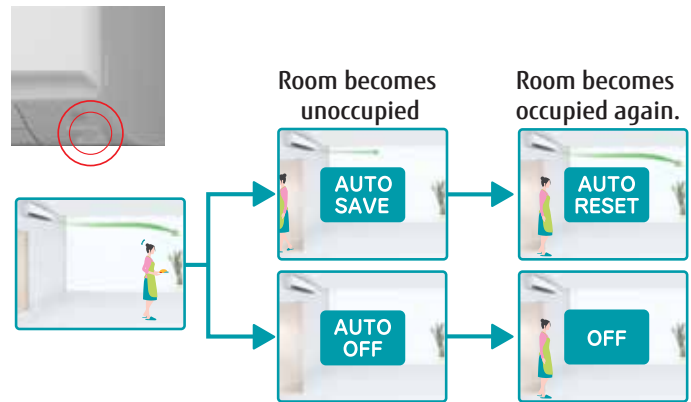

Specifications

Model name		ASUB18TLAV2	ASUB24TLAV2	ASUA30TLAV2	ASUA36TLAV2
Power Source		1 Phase - 208 / 230V ~ 60Hz			
Capacity	Cooling	BTU/h 18,000	24,000	30,000	34,000
	Heating	BTU/h 20,000	27,000	34,000	38,000
Input Power		kW 5.3	7.0	8.8	10.0
		W 32	60	74	103
Airflow rate	High	CFM (m ³ /h) 494 (840)	647 (1,100)	848 (1,440)	954 (1,620) / 895 (1,520)*
	Med-Hi	-	-	706 (1,200)	765 (1,300)
	Med	453 (770)	536 (910)	618 (1,050)	659 (1,120)
	Lo-Hi	-	-	553 (940)	577 (980)
	Low	406 (690)	430 (730)	524 (890)	524 (890)
	Quiet	-	-	412 (700)	412 (700)
Sound pressure level	High	dB(A) 41	48	53	55 / 54 *
	Med-Hi	-	-	49	51
	Med	39	43	45	47
	Lo-Hi	-	-	42	43
	Low	35	35	39	39
	Quiet	-	-	33	33
Dimensions (H x W x D)		in. (mm) 12-5/8 x 39-5/16 x 9-3/8 (320 x 998 x 238)		13-3/8 x 45-1/4 x 11 (340 x 1,150 x 280)	
Weight		lbs. (kg) 33 (15)	33 (15)	40 (18)	40 (18)
Connection pipe diameter	Liquid (Flare)	in. (mm) 1/4 (6.35)	3/8 (9.52)	3/8 (9.52)	3/8 (9.52)
	Gas (Flare)	1/2 (12.70)	5/8 (15.88)	5/8 (15.88)	5/8 (15.88)
Drain hose diameter (I.D./O.D.)		in. (mm) 9/16 / 5/8 to 11/16			

Note : Specifications are based on the following conditions: Built-in protective functions may limit capacity or shut off unit if unit is operated outside of unit design operating temperature ranges.

Cooling : Indoor temperature of 80°F (26.7°C) DB/67°F (19.4°C) WB; and outdoor temperature of 95°F (35°C) DB/75°F (23.9°C) WB. Heating : Indoor temperature of 70°F (21.1°C) DB/60°F (15.6°C) WB, and outdoor temperature of 47°F (8.3°C) DB/43°F (6.1°C) WB. Pipe Length : 25ft. (7.5m), Height difference : 0ft. (0m) (Outdoor unit - indoor unit).

*Cooling / Heating

6-speed fan control

With 6 fan speeds to choose from, the ASUB30TLAV2 and ASUB36TLAV2 models operate as quietly as 33 dB(A).

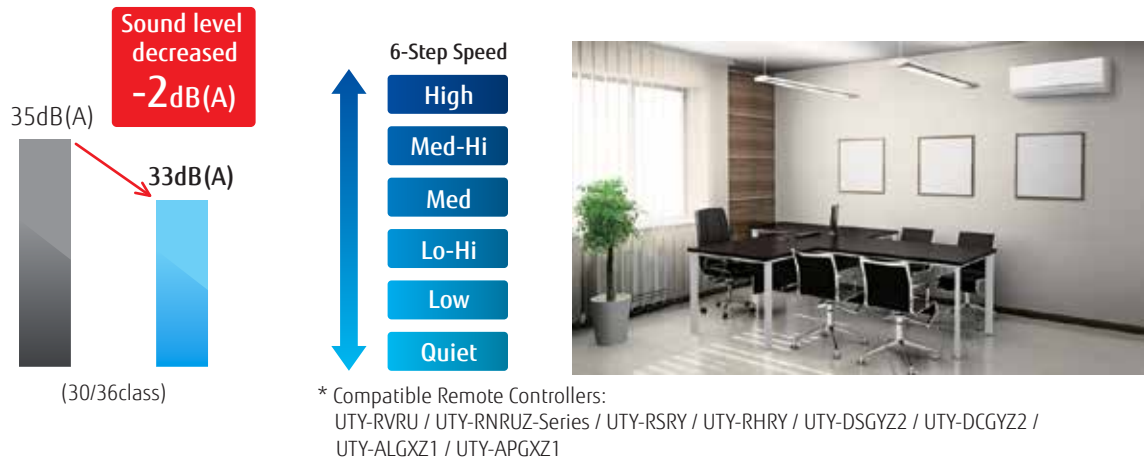

Optional Accessories

- Kagami Wired Remote ControlUTY-RVRU
- Wired Remote Control (Touch Panel) UTY-RNRUZ*
- Simple Remote Control..... UTY-RSRY, UTY-RHRY
- Wireless Remote Control..... UTY-LNHU

Dimensions

(Unit: In (mm))

Models:
ASUB18TLAV2 / ASUB24TLAV2

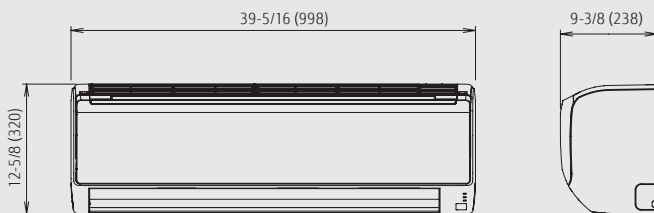

Models:
ASUB30TLAV2 / ASUB36TLAV2

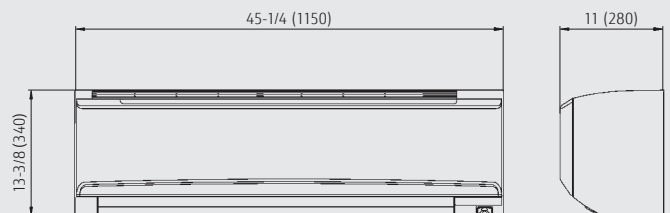

DX-Kit for air handling applications

- UTP-VU30A
- UTP-VU60A
- UTP-VU90A
- UTY-VDGU

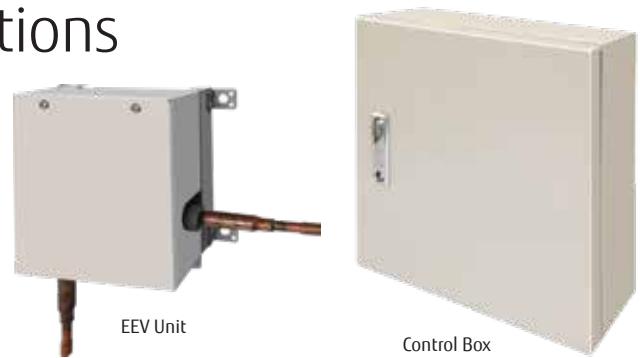

Fujitsu's DX-Kit enables a 3rd party Air Handling Unit to be fully integrated into an AIRSTAGE VRF system. This enables the benefits of advanced inverter compressor technology to extend to standard air handling equipment.

The DX-Kit offers a seamless integration and optimized design flexibility while making installation and commissioning efficient.

Different control strategies for optimized control of air handling & fan coil units

- When connecting to an air handling unit, the supply air temperature can be controlled by the air discharge sensor.
- When connecting to a fan coil unit, the room temperature can be controlled by the return air temperature sensor.

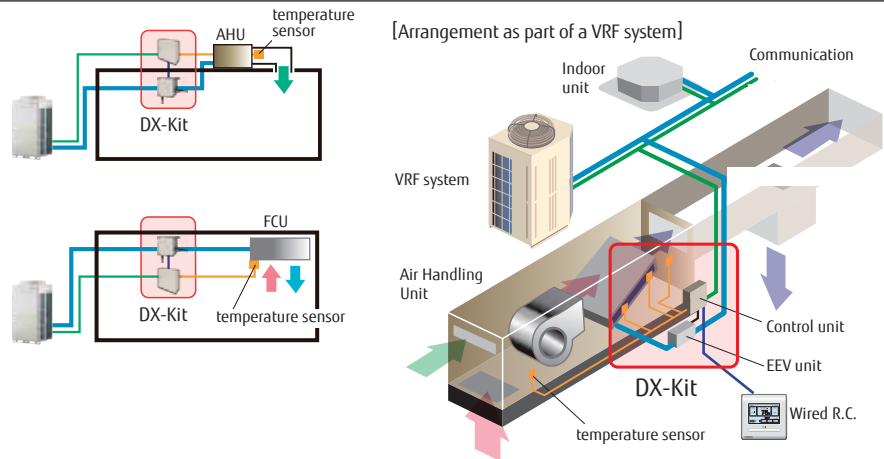

Supports wide range of capacities

- Connectable capacity range: 18,000 BTU/h to 168,000 BTU/h.
- 2 EEV units can be connected in parallel for up to 168,000 BTU/h large capacity units.

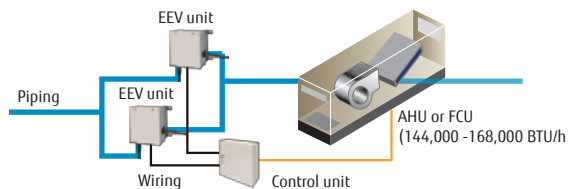

Variety of controls to match the application

- Central control using VRF controllers or central management (BMS) controller.

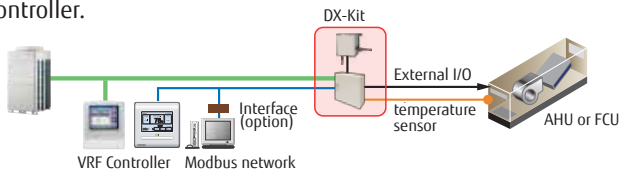

- Central control from external 3rd party controller

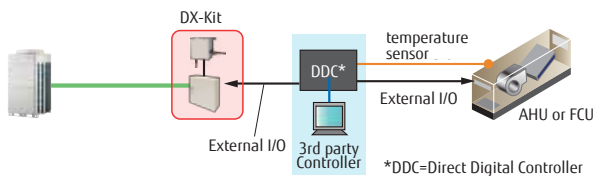

Summary of input/output functions

Inputs

- ON/OFF
- Set temperature
- Capacity demand
- Heating / Cooling operation mode
- Fault information

Outputs

- ON/OFF indication
- Fan ON/OFF indication
- Thermo ON/OFF indication
- Defrost indication
- Fault indication

Modbus control

- Possible to control via Modbus interface for integration into a BMS system.

DX-Kit system design parameters

- Connectable VRF series: J-III, J-IV, J-IVS, VU-V
- Connectable DX-Kit system capacity range: 50 to 100% of the outdoor unit capacity
- Connectable DX-Kit system capacity range with indoor units: 30% or less of the outdoor unit capacity
- Max wiring length from control unit: 32ft. (10m)
- Max piping length between EEV unit and indoor unit: 16ft. (5m)
- Control unit and EEV unit can be installed outdoors.

[Connectable capacity]

- Single connection

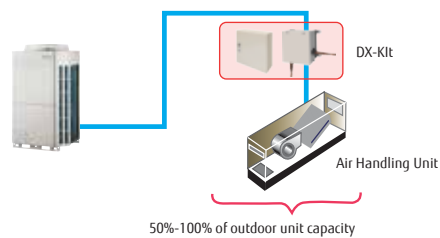

- Mixed connection

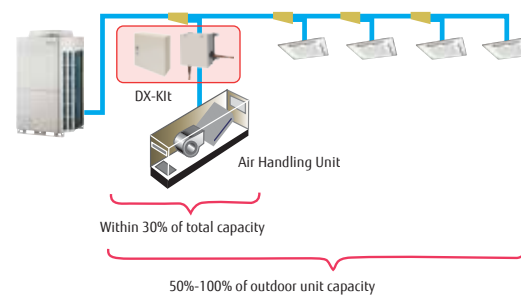

[Piping and wiring length]

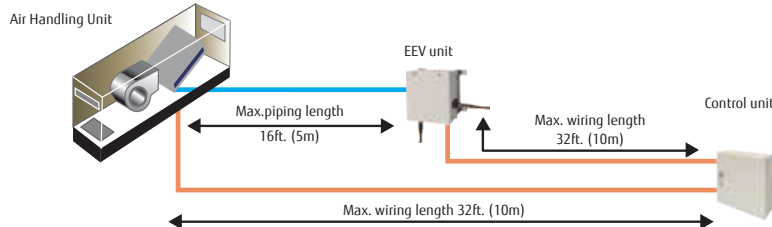

[For 2EEV units connection (option)]

- Separation Tube kit : UTP-LX180A



Specifications

EEV Unit		UTP-VU30A			UTP-VU60A			UTP-VU90A		UTP-VU90A×2	
Connectable capacity	BTU/h	18,000	24,000	30,000	36,000	48,000	60,000	72,000	96,000	144,000	168,000
Capacity	Cooling	18,000	24,000	30,000	36,000	48,000	60,000	72,000	96,000	144,000	168,000
	Heating	20,000	27,000	34,000	40,000	54,000	67,000	81,000	108,000	162,000	188,000
Airflow Rate(Reference value)	CFM (m ³ /h)	624 (1,060)	706 (1,200)	895 (1,520)	941 (1,600)	1,177 (2,000)	1,318 (2,240)	2,095 (3,560)	2,354 (4,000)	3,767 (6,400)	4,709 (8,000)
Dimensions (H×W×D)	in.(mm)	6-5/16 x 8-11/16 x 3-9/16 (160 × 220 × 90)							6-5/16 x 8-11/16 x 3-9/16 (160 × 220 × 90) × 2		
Weight	lbs.(kg)	4.4 (2.0)							4.4 (2.0) × 2		
Connection pipe diameter (Liquid)	in.(mm)	ø3/8 (9.52)			ø3/8 (9.52)			ø1/2 (12.70)			
Control box		UTY-VDGU									
Power source	V/ø/Hz	208-230 / 1 / 60									
Dimensions (H×W×D)	in.(mm)	15-3/4 x 15-3/4 x 4-3/4 (400 × 400 × 120)									
Weight	lbs.(kg)	22.0 (10.0)									

Note: Specifications are based on the following conditions:

Cooling: Indoor temperature of 80°F(26.7°C)DB/67°F(19.4°C)WB, and outdoor temperature of 95°F(35°C)DB/75°F(23.9°C)WB.

Heating: Indoor temperature of 70°F(21.1°C)DB/60°F(15.6°C)WB, and outdoor temperature of 47°F(8.3°C)DB/43°F(6.1°C)WB.

Pipe length: 25ft.(7.5 m)

Voltage : 230 [V]

Effective heat exchange and simultaneous outside air ventilation

High Efficiency and low noise levels are achieved by using a highly efficient heat exchanger design. A comfortable air conditioned space is achieved by conveniently selecting whether to use heat exchange or normal ventilation setting, according to the requirements of the conditioned space.

VENTILATION

VENTILATION Lineup

- p. 73 Outdoor Air Unit
- p. 75 HRV / ERV Solutions

Lineup

Outdoor Air Unit	 AAUA48TLAV	 AAUA72TLAV	 AAUA96TLAV				
HRV / ERV	 VS500SQh / VS500SQe	 VS250 CMh/e	 VS400 CMh/e	 VS900 CMh/e	 VS1200 CMh/e	 VS1000RT/RTe	 VS3000RT/RTe



Outdoor Air Unit

AAUA48TLAV

AAUA72TLAV

AAUA96TLAV



AAUA48



AAUA72



AAUA96

The outdoor air unit provides a zoned and decentralized solution to bringing in conditioned outside air to the space. Both outside air treatment and space conditioning is provided from one flexible and efficient VRF system.

One VRF system can provide efficient air conditioning and air supply at the same time

J-SERIES V-SERIES

Outdoor Air Unit

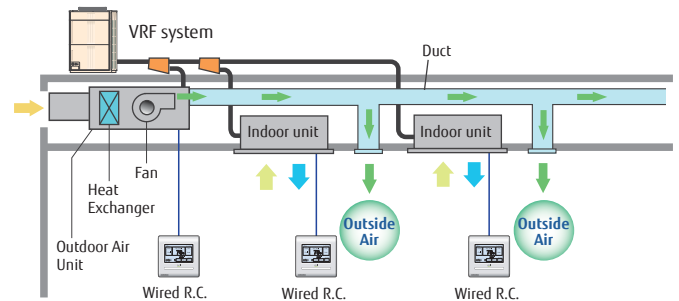
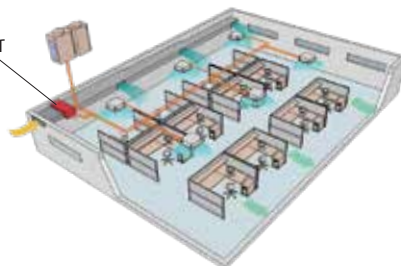

* See Product Documentation for detailed design guidelines.

Model name			AAUA48TLAV	AAUA72TLAV	AAUA96TLAV
Power source			1 Phase ~ 208/230V 60Hz		
Capacity	Cooling	BTU/h	48,000	72,000	96,000
	Heating		30,000	47,000	59,000
Input power	Cooling/Heating		W	179	292
				370	
Airflow rate		CFM	636	989	1,236
		(m ³ /h)	(1,080)	(1,680)	(2,100)
Static pressure range		in.WG	0.20 to 0.74 (50 to 184)	0.20 to 0.80 (50 to 200)	0.20 to 0.96 (50 to 239)
Standard static pressure		(Pa)	0.74 (184)	0.80 (200)	0.80 (200)
Sound pressure level		dB (A)	42	44	47
Dimensions (H × W × D)		in. (mm)	16-3/4×53-13/16×22-1/2 (425×1,367×572)	16-3/4×53-13/16×22-1/2 (425×1,367×572)	17-11/16×62-5/16×27-9/16 (450×1,583×700)
Weight		lbs. (kg)	108 (49)	123 (56)	159 (72)
Connection Pipe Diameter (Small / Large)		in. (mm)	Ø3/8 / Ø3/4 (Ø9.52 / Ø19.05)	Ø1/2 / Ø7/8 (Ø12.70 / Ø22.22)	Ø1/2 / Ø7/8 (Ø12.70 / Ø22.22)
Operation Range	Cooling	°FDB (°CDB)	41 to 109 (5 to 43)	41 to 109 (5 to 43)	41 to 109 (5 to 43)
	Heating		19 to 70 (-7 to 21)	19 to 70 (-7 to 21)	19 to 70 (-7 to 21)
Refrigerant			R410A	R410A	R410A

Note : Specifications are based on the following conditions.
 Cooling : Outdoor temperature of 91°FDB (33°CDB) / 82°FWB (28°CWB).
 Heating : Outdoor temperature of 32°FDB (0°CDB) / 27°FWB (-2.9°CWB).
 Pipe length : 25ft. (7.5 m)

Outdoor Air Unit (continued)

High energy savings and flexible duct design by using DC motor

- DC fan motor with permanent magnet technology for energy efficient operation.
- External static pressure capabilities of up to 0.96" W.G. (50 to 240 Pa) allows for flexibility with duct work and filtration choices.

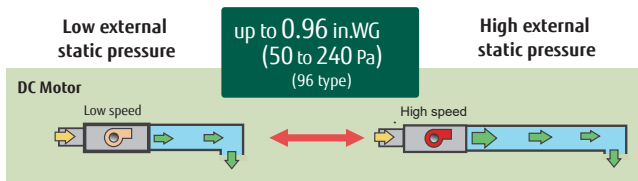
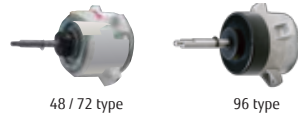

Various Controllers

Design flexibility with many optional controllers, such as individual remote controls, central controllers and building management systems.

Remote Controls



Central Controller

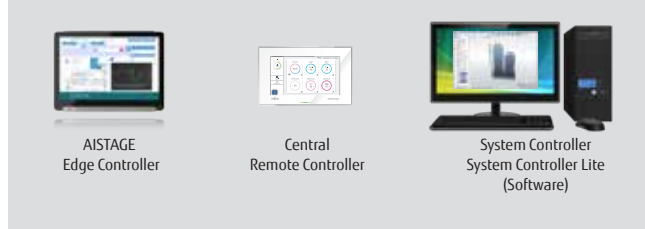

Efficient compact design

- Compact and low profile design reduces the required installation space and can eliminate mechanical rooms or separate mounting spaces associated with traditional outdoor air systems.

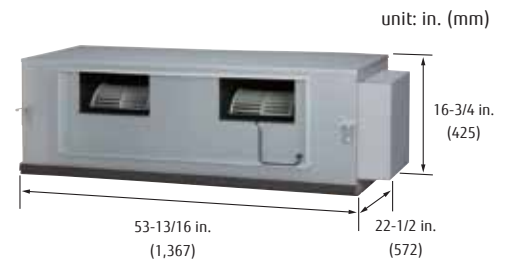

Optional Accessories

- IR Receiver UTB-YWC
- Wireless Remote Controller UTY-LNHU

AAUA48TLAV

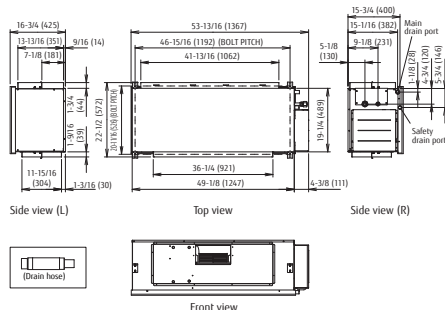

AAUA72TLAV

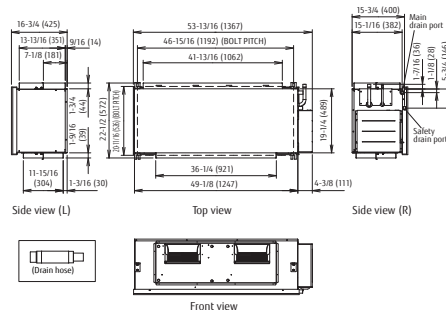

AAUA96TLAV

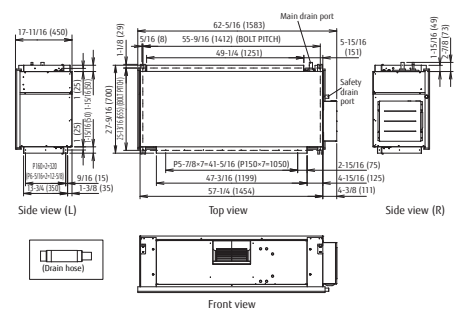

HRV / ERV Solutions

Improved comfort and health in buildings

When the Ventacity HRV/ERV system is connected to optional sensors, it will optimize ventilation, providing just the right amount of outside air when and where needed for maximum health and comfort. The combination of zoned heating and cooling from AIRSTAGE systems with outside air from Ventacity's HRV/ERV systems provides a healthy environment for building occupants, translating into higher building value.

High Efficiency

The AIRSTAGE VRF system - which includes a variety of Building Management System controls - combined with a Ventacity HRV/ERV system makes an intelligent, ultra-efficient solution for buildings, offering tremendous Energy Use Intensity (EUI) reductions and savings in the building's annual energy use per unit area.

Specifications



MODEL NAME		VS500SQh / VS500SQe	VS250 CMh/e	VS400 CMh/e	VS900 CMh/e	VS1200 CMh/e	VS1000RT/RTe	VS3000RT/RTe
Ventilation Flow - Max	cfm	539	309	467	992	1492	1,020 cfm	3,300 cfm
Ventilation Flow - Typical	cfm	117 to 500	60 to 270	120 to 480	200 to 900	300 to 1200	180 to 1,000 cfm	750 to 3,000 cfm
Ventilation Type		Heat Recovery Ventilator (HRV) / Energy Recovery Ventilator (ERV)						
Heat Exchanger		Counterflow Aluminum Static Plate / Counterflow Polymer Static Plate						
Heat Recover - Max	%	90 / 83	86.1/79.2	86.1/79.2	86.1/79.2	86.1/77.9	92 / 85	90 / 85
Temperature Range	°F	40 to 104	41 to 104	41 to 104	41 to 104	41 to 104	-13 to 140	-13 to 122
Modes		CAV, DCV, Economizer	CAV, DCV, VAV, BMS, Economizer			CAV, DCV, VAV, BMS, Economizer		
MECHANICAL								
Weight	lbs.	280 / 288	165	210	375	540	618 / 662	1654 / 1720
Dimensions	in.	84.3 x 44 x 17.9	46.9 x 12.2 x 30.7	55.1 x 12.2 x 42.5	66.9 x 15.4 x 54.5	78.7 x 18.5 x 67.3	63.6 x 35.2 x 52.5	86.3 x 48.3 x 73.5
OA Filter (2" or 4") MERV13	in.	15.16 x 16 x 3.75	11.2 x 9.25 x 3.78	17.9 x 9.25 x 3.78	23.03 x 12.2 x 3.78	29.53 x 15.55 x 3.78	17.5 x 28 x 3.75	51 x 26.5 x 3.75
RA Filter (2") MERV8	in.	10.6 x 16.7 x 2	11.2 x 9.25 x 3.78	17.9 x 9.25 x 3.78	23.03 x 12.2 x 3.78	23.03 x 12.2 x 3.78	16.5 x 28 x 17.5	51 x 25.25 x 3.75
ELECTRICAL								
Power Supply	kW	5.1	1.78	3.29	6.26	7.9	7	20.2
Voltage		240 VAC, 1-Phase, 60Hz	208-240 VAC	208-240 VAC	208-240 VAC	208-240 VAC	240 VAC, 1-Phase, 60Hz or 208/240 VAC, 3-Phase, 60Hz	*208/240 VAC, 3-Phase, 60Hz or 480 VAC, 3-Phase, 60Hz*
De-Ice Preheater	kW	2.1	1.51	2.93	5.3	6.9	6	16.3
Maximum Power - 1 Fan	W	322	125	170	470	503	500	1,900

Ductless

The VS500SQ is a ductless HRV/ERV for decentralized applications. The VS500SQ optimizes for energy efficiency and healthy indoor air quality, while offering ultra-quiet operation and no drafts.

Top Applications: Classrooms, offices and conference rooms.



Ducted

VS1000RT and VS3000RT make up a line of Smart Ventilation™ Management systems with a rugged design for easy rooftop or mechanical room installation that optimize healthy indoor air quality while minimizing building energy usage.

Top Applications: New and existing retail spaces, offices, restaurants, schools, public spaces and multifamily residential buildings.



Ventilator

VS-CM Series HRVs & ERVs for installation above drop ceilings. Operates at much higher energy efficiency (up to 93%) which saves much more energy and significantly lowers operating costs. Four capacities to choose from.



Passive House certified

The VS1000RT is the first Passive House, UL, CSA Certified counterflow heat recovery ventilation (HRV) product in North America.

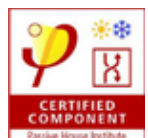

Light Commercial & Commercial CONTROL SYSTEMS OPTIONAL PARTS & ACCESSORIES



- p. 78 Control System Overview
- p. 80 Remotes & Controllers Features Table
- p. 110 Optional Parts Overview

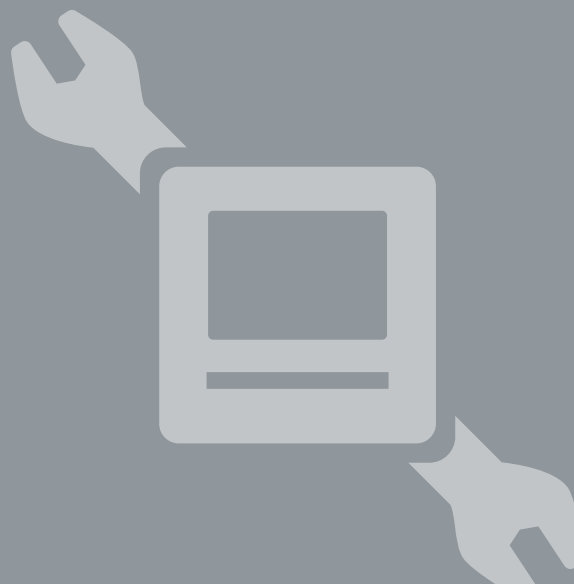

The flexibility of the AIRSTAGE controls architecture meet customer needs through a variety of offerings. Available are wired and wireless individual remote controllers, central remote controllers that simultaneously control multiple indoor units, and a variety of converters that link with other systems.

CONTROL SYSTEMS



INDIVIDUAL CONTROLS

- p. 81 Kagami Wired Remote Control
- p. 83 Touch Panel Wired Remote Control
- p. 85 Simple Remote Control
with or without Operation Mode
- p. 86 Wireless Handheld Remote Control
- p. 86 IR Receiver Units

CENTRAL CONTROLLERS

- p. 87 AIRSTAGE Cloud & Edge Controller
- p. 90 Central Remote Controller
- p. 91 System Controller **Software**
- p. 91 System Controller Lite **Software**

BMS GATEWAYS

- p. 95 AIRSTAGE Integration Manager™
(powered by Niagara)
- p. 97 BACnet® Gateway **Hardware**
- p. 97 BACnet® Gateway **Software**
- p. 98 Network Converter for LONWORKS®
- p. 98 MODBUS® Converter

Wi-Fi INTERFACES

- p. 99 USB WiFi Adapter - AIRSTAGE Mobile
- p. 99 UART WiFi Adapter - AIRSTAGE Mobile
- p. 99 UART WiFi Adapter - AC Cloud Control



CONVERTERS / ADAPTERS

- p. 100 Network Converters
- p. 100 Signal Amplifier
- p. 101 External Switch Controller
- p. 102 3rd Party Thermostat Converter

SERVICE & MONITORING

- p. 103 Service Tool Kit **Software**
- p. 104 Web Monitoring Tool **Software**

DESIGN TOOLS

- p. 106 Design Simulator
- p. 107 BIM
- p. 108 CYPETHERM

OPTIONAL PARTS & ACCESSORIES



ACCESSORIES

- p. 110 Accessories for Ducted Units, Large
Cassette, Compact Cassette
- p. 111 External Power Supply Unit
- p. 112 Separation Tubes etc.
- p. 113 RB Units
- p. 114 Auto Louver Grille Kit
- p. 115 Wind Baffles, Hail Guards, Snow
Hoods
- p. 116 Airzone
- p. 118 Hirise 360 Kit



VRF J Series



VRF V Series

Control System Overview

For VRF

User's needs are supported by offering a variety of controls, such as individual control, central control and building management control options.

Air Conditioning Individual Controls



Kagami Wired Remote Control
UTY-RVRU

p. 81



Touch Panel Wired Remote Control
UTY-RNRUZ*

p. 83



Simple Remote Control
UTY-RSRY
UTY-RHRY (without operation mode)

p. 85



Wireless Remote Control
UTY-LNHU

p. 86



IR Receiver Unit
UTB-YWC For Ducted Models
UTY-TRHX For TLAV2 Ducted Models

p. 86



UTY-LBHDX For Circular Flow Cassette

p. 86

Air Conditioning Centralized Controls



AIRSTAGE Edge Controller
UTY-DSGYZ2

p. 87



Central Remote Controller
UTY-DCGYZ2

p. 90



System Controller Software
UTY-APGXZ1
UTY-ALGXZ1 (Lite edition)

p. 91



BMS Gateways

For external control via Building Management Systems (BMS) or Home Automation Systems (HAS)

AIRSTAGE Integration Manager™
powered by Niagara
FUJ-VRF-8025
FUJ-VRF-8125



p. 95

BACnet® Gateway
UTY-VBGX **Hardware**

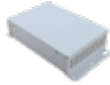

BACnet® Gateway
UTY-ABGXZ1 **Software**

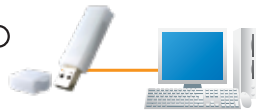

BACnet® Gateway
FJ-AC-485-1 **One-to-One**



p. 97

Network Converter
(For LONWORKS®)
UTY-VLGX

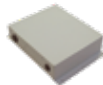

p. 98

MODBUS® Converter
UTY-VMGX



p. 98



Wi-Fi Interfaces

For control via cloud-based applications

UART WiFi Adapter
(AIRSTAGE Mobile)
UTY-TFSXJ4



UART Wi-Fi Adapter
(AC Cloud Control)
FJ-AC-WIFI-1



3-Wire Wi-Fi Adapter
(AC Cloud Control)
FJ-RC-WIFI-1NA



p. 99

Converter/Adapter

For system expansion and 3rd-party controls

Network Converter
(DC power supply)
UTY-VTGX



Network Converter
(AC power supply)
UTY-VGGXZ1

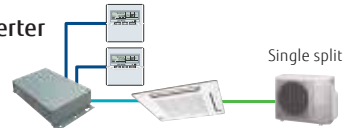

p. 1020

Signal Amplifier
UTY-VSGXZ1



p. 100

External Switch Controller
UTY-TERX



Card-key
(Locally purchased)

p. 101

3rd Party Thermostat Converter
UTY-TTRXZ1













24V 3rd-party thermostat
(Locally purchased)



p. 102

CONTROL SYSTEMS

		Zone Controllers					Central Controllers				Wi-Fi Interface	
												
Model name		UTY-RVRU	UTY-RNRUZ*	UTY-RHRY	UTY-RSRY	UTY-LNHU	UTY-DSGYZ2	UTY-DCGYZ2	UTY-APGXZ1	UTY-ALGXZ1	UTY-TFSXJ4	FJ-AC-WIFI-1
Max. controllable remote control groups		1	1	1	1	1	128	100	1600	400	1	1
Max. controllable indoor units		16	16	16	16	16	128	100	1600	400	1	1
Max. controllable groups		—	—	—	—	16	128	16	1600	400	—	—
Air Conditioning Control Function	On / Off	• *3	• *3	•	•	•	•	•	•	•	•	•
	Operation mode setting	•	•	—	•	•	•	•	•	•	•	•
	Fan speed setting	•	•	—	•	•	•	•	•	•	•	•
	Temp. setpoint setting	•	•	•	•	•	•	•	•	•	•	•
	Room temp. setpoint limitation	•	•	•	•	—	•	•	•	•	—	•
	Test operation	•	•	•	•	•	•	•	—	—	—	—
	Vert. Airflow Dir. / Swing setting	•	•	—	•	•	•	•	•	•	•	•
	Horiz. Airflow Dir. / Swing setting	•	•	—	—	•	•	•	•	•	•	•
	Individual louver control	•	•	—	—	—	•	—	—	—	—	—
	Group setting	—	—	—	—	—	•	•	•	•	•	—
	RC prohibition	—	—	—	—	—	•	•	•	•	—	—
	Anti freeze setting	—	—	—	—	—	•	•	•	•	—	—
	Set temp. auto return	•	•	—	—	—	•	—	—	—	—	—
	Away setting	•	•	—	—	—	•	—	—	—	—	—
	Economy mode setting	•	•	—	—	•	•	•	•	•	•	—
Occupancy/Human sensor setting	—	—	—	—	—	•	—	•	•	•	—	
Display	Error	•	•	•	•	—	•	•	•	•	•	•
	Defrosting	•	•	•	•	—	•	•	•	•	•	—
	Current time	•	•	—	—	•	•	•	•	•	—	—
	Day of week	•	•	—	—	—	•	—	•	•	—	—
	RC prohibition	•	•	•	•	—	•	•	•	•	•	—
	Cooling/heating priority	•	•	•	•	—	•	•	•	•	—	—
	Address display	•	•	•	•	—	•	•	•	•	—	—
	Room temp	•	•	•	•	—	•	—	—	—	•	•
	Multi language	•	•	—	—	—	•	•	•	•	•	•
	Daylight Saving Time setting (Summer)	•	•	—	—	—	•	•	•	•	—	—
	Time zone setting	—	—	—	—	—	•	—	—	—	•	•
	Name registration	•	•	—	—	—	•	•	•	•	•	•
	Backlight	•	•	•	•	—	• *7	•	—	—	—	—
	2D floor layout / 3D building display	—	—	—	—	—	—	—	•	—	—	—
	Service Tool functionality	—	—	—	—	—	• *8	—	—	—	—	—
Timer	Schedule timer	Period	Week	Week	—	—	Week / Year	Week	Year	Year	Week	Year
		On/Off, Temp, Mode: Events per day	8 *3, *4	8 *3, *4	—	—	Unlimited	20	144	144	—	10
	On/Off timer	—	—	—	—	•	—	—	—	—	—	—
	Sleep timer	—	—	—	—	•	—	—	—	—	—	—
	Program timer	—	—	—	—	•	—	—	—	—	—	—
	Auto off timer	•	•	—	—	—	•	—	—	—	—	—
	Day off	•	•	—	—	—	•	•	•	•	—	—
Min. unit of timer setting (Minutes)	10-30	10-30	—	—	5	1	10	10	10	—	—	
Control	Status monitoring system	—	—	—	—	—	•	•	•	•	•	•
	Electricity charge apportionment	—	—	—	—	—	•	—	•	°	—	—
	Error history	•	•	—	—	—	•	•	•	•	•	•
	Emergency stop	—	—	—	—	—	•	• *2	—	—	—	—
	Remote management	—	—	—	—	—	•	—	•	°	•	•
	Energy saving management	—	—	—	—	—	•	—	°	°	•	—
	Low noise mode	—	—	—	—	—	•	—	—	—	•	—
BMS	Third party Modbus communication	—	—	—	—	—	•	—	°	°	—	—
Administration	Error / event notification	—	—	—	—	—	Email, SMS	—	•	•	• *5	• *5
	Multi user access levels	—	—	—	—	—	•	—	•	•	•	•
	Key lock	•	•	—	—	—	•	•	•	•	•	•
	Refrigerant Cycle Monitor *6	•	•	—	—	—	•	—	—	—	—	—
	OTA updates	—	—	—	—	—	•	—	—	—	•	•

*1 "Operation mode" setting is not available for this model. *2 This function is available only through external input. control. *3 On / Off (Occupied / Unoccupied) *4 Mode deleted *5 Notification of errors, operating mode changes, and temperature alarms *6 Monitoring functions similar to Service Tool *7 Seven levels of brightness

—: Not supported yet •: Supported °: Optional function

Kagami Wired Remote Control

(2-wire): UTY-RVRU

KAGAMI
КІВРІВ



Simple, clean design that harmonizes with the space

The new UTY-RVRU Kagami Controller is a touch enabled, intuitive and stylish-looking controller, compatible with 2-Wire H, J, and V-Series indoor units.

Features

- Sleek, minimalist design that harmonizes with the space
- Large, easy to read, anti-fingerprint touch screen with auto dimming
- Simple, intuitive operation, with only the necessary functions and minimal screen transitions - swipe left/right to select settings, up/down to adjust settings
- Initial setup and function settings via BLE connection to Remo Set app on smart device, or manually on the controller
- Easily transfer settings between controllers, reducing install time
- Custom logo import and display and masking of settings for hotels
- Control and monitoring for commonly used functions, including:
 - On/Off, Operation Mode, Fan Speed, and Air Flow Direction
 - Room temperature display with temperature correction
 - Current time display, adjusts for Daylight Savings
 - Auto-Off and Weekly Timers
 - Custom Auto (dual setpoint) function
 - Away / Eco Away setting
 - Economy / Energy Saving Fan / Optimum Start operation
 - Emergency Heat control
 - Filter Status and Reset
 - Anti-Freeze operation
 - Economy / Energy Saving Fan / Optimum Start operation
 - Error display and history
 - Refrigerant Cycle Monitor of select sensor values
 - Test Run function
- Password and child lock protection
- Multi-language (English, Chinese, French, German, Spanish, Russian, Polish, Italian, Greek, Portuguese, Turkish and Dutch)
- Energy Star Compliant
- Meets California 2022 Title 24 requirements
- Retains and displays HVAC contractor contact info for support
- 90-day warranty

Intuitive menu operation

Swipe left/right to choose a setting, and up/down to change values.



Determine operating status at a glance

Subtle color-coded LED displays current operation mode, even when controller is idle.



Logo Display for Hotels

KAGAMI can be customized with logos from hotels or other properties. Images are sent via BLE* connection where data is saved on the flash ROM built into each controller.



Limited Visibility of Settings for Hotels

KAGAMI features a function that enables hotels and other clients to "hide" settings from the displays so that their guests cannot change system settings.

Settings are possible through the smartphone app via BLE* connection to the remote controllers. (Settings can also be adjusted manually on the remote controllers as usual.)

*BLE: Bluetooth Low Energy



The design goal was to create a controller that is considered interior décor. This was achieved through the use of mirrors, glass, and layered elements that produce a frosted clear panel that appears to float. The end result, KAGAMI, feels as if it is one with the wall.

KAGAMI Wired Remote Control UTY-RVRU (continued)

Installation/Maintenance

Smartphone Application

To improve workability, our smartphone app now enables users to make initial settings of the remote controllers and adjust function settings of the indoor unit via BLE^{*1} connection.

Settings can also be adjusted manually on the remote controllers as usual.

Method 1

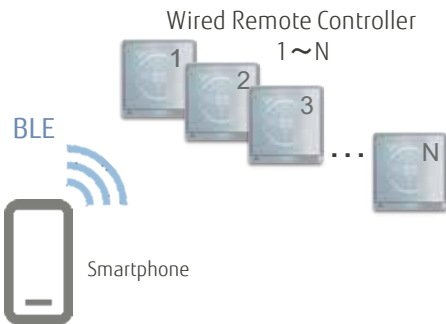

Send the setting values entered by the smartphone to the remote controller^{*2}

*1 BLE: Bluetooth Low Energy
*2 Smartphone: Wired Remote Controller = 1 : 1

Method 2

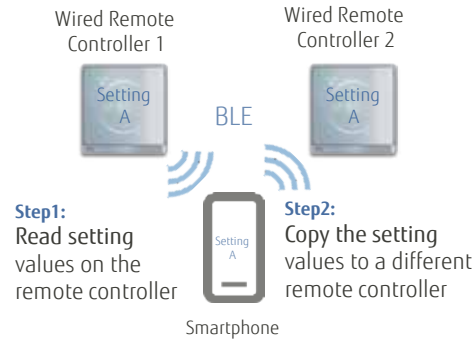

Read the setting values of a different remote controller and send a copy of them^{*2}

- Step1: Read setting values on the remote controller
- Step2: Copy the setting values to a different remote controller

Support Functions

Display Contractor Contact Information

The remote controllers can retain and display HVAC contractor contact information. Contact information can be sent from the smartphone app to the remote controllers via BLE^{*}.

*BLE: Bluetooth Low Energy

Refrigerant Cycle Monitor

Wired Remote Controller (Touch Panel) will support the display of certain sensor values for maintenance and service support.

Remo Set App (free download)

Set up your new Kagami controller via Bluetooth from your smartphone (or directly at the controller).

Features:

- Initial configuration
- Function setting
- Custom logo import
- Copy settings between controllers

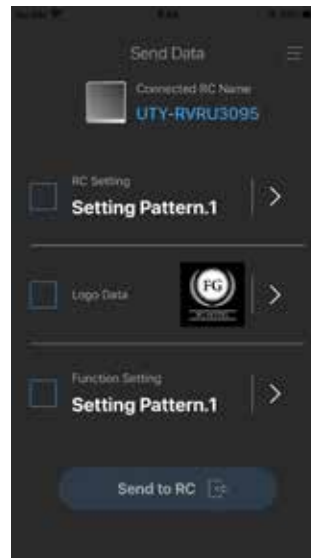

Main Screen

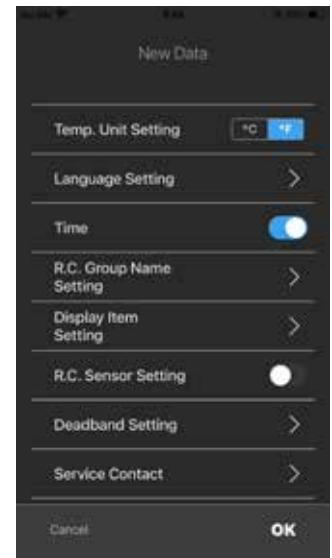

Setting Screen

Specifications

Model name	UTY-RVRU
Power source	DC 12V
Dimensions (H x W x D) (in. (mm))	4-13/16 x 4-9/16 x 1 (121.5 x 116 x 26)
Weight (oz.(g))	7.94 (225)

Touch Panel Wired Remote Control

(2-wire): UTY-RNRUZ*

Max. controllable
16
indoor units

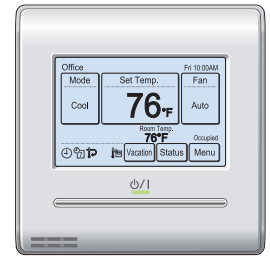

User friendly operation with high-definition large STN-LCD touch screen

- Built-in temperature sensor
- Built-in weekly/Daily timer (ON/OFF (Occupied/Unoccupied), Temp.)
- Backlight with ambient sensor adjusts to the room's light level
- Room temperature display
- Temperature set point limitation
- Multi-language (English, Chinese, French, German, Spanish, Russian, Polish, Italian, Greek, Portuguese, Turkish and Dutch)

High performance and compact size

- Flexible remote controller with individual control mode and various energy saving controls functions.



Accurate and comfortable control

- Built in air temperature sensor for accurate control and display of indoor air temperature.

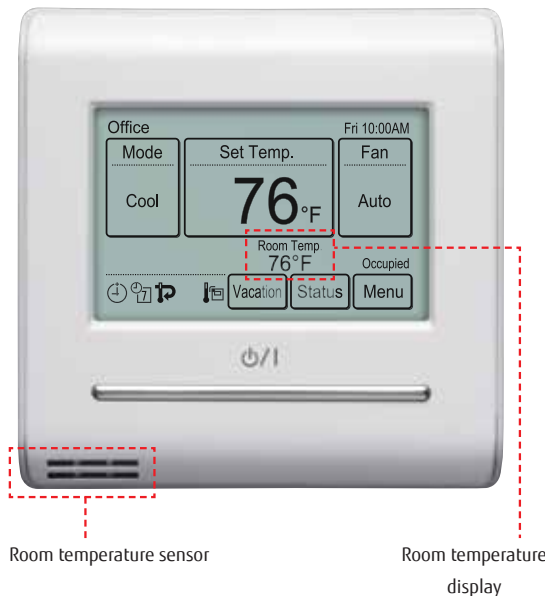

Room temperature sensor

Room temperature display

Backlight

- Backlight enables easy operation in a dark room.
- Choose to have the backlight display stay on for 30 or 60 seconds.

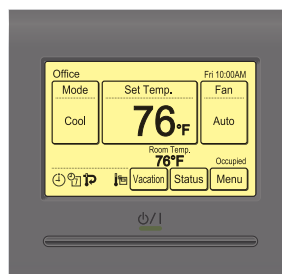

Various energy saving settings

Auto OFF Timer

- The indoor unit automatically turns off after a set time has passed.
- The time interval for which auto off works can be set.

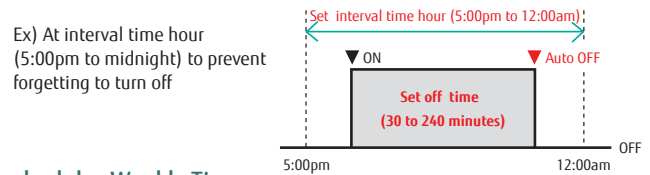

2 schedules Weekly Timer

- 2 schedules such as for the summer and winter can be set.
- 8 setting changeable per day of week (Setting items: ON / OFF (Occupied/Unoccupied), Temperature, Time)

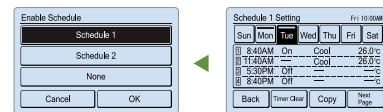

Schedule 1 (Summer schedule)

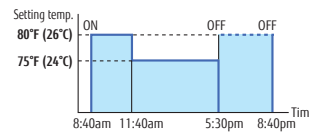

Schedule 2 (Winter schedule)

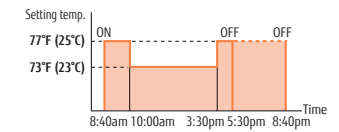

Optimum start function

- Provides configurable operation start to get the space to set temperature before scheduled time.

Cooling operation

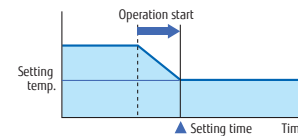

Heating operation

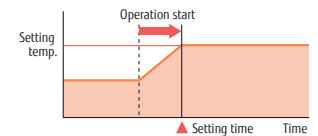

Set Temperature Auto Return

- The set temperature automatically returns to the previous setting.
- The time range in which the set temperature can be changed is 10 to 120 minutes.

Set Temperature Upper and Lower Limit Setting

- Set temperature range can be set for each operation mode. (Cooling / Heating / Auto)

Cooling operation

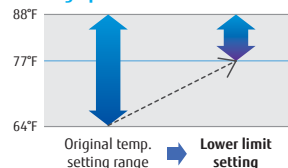

Heating operation

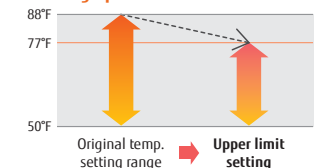

Touch Panel Wired Remote Control UTY-RNRUZ* (continued)

Additional functions

Away mode

- Cooling / Heating is automatically started when the room temperature reaches a setting temperature even if the indoor unit is off.

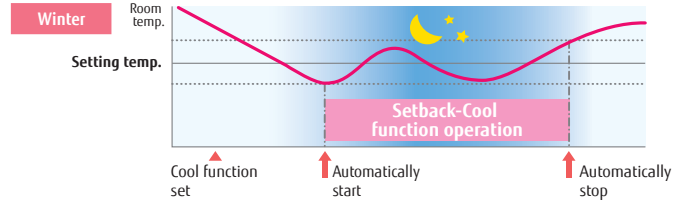
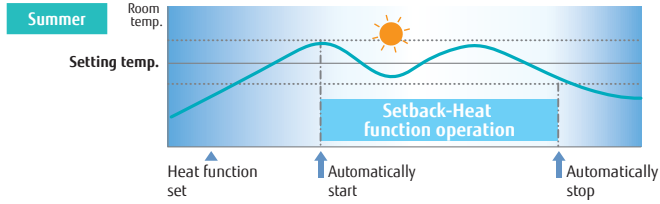

Displays setting status and limitations

- The remote controller settings can be easily checked

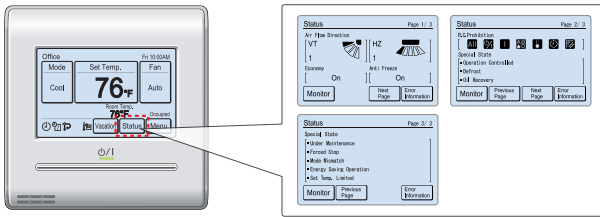

Child lock

- Lock / unlock method: Push the ON/OFF button on the screen (4 seconds)

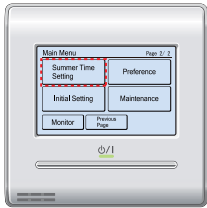

Daylight savings time (Summer Time)

- Provides Daylight Savings adjustment option.

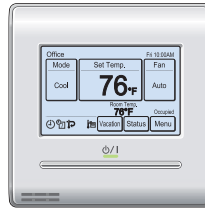

Name registration

- Easy identification of Indoor units using the user programmed names.

Monitor of EEV pulses from within the controller

Simplified installation

Easy to install using non-polar 2-wire communication cable

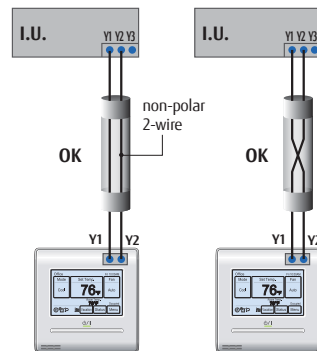

Auto Address Setting/Setting Position Notification

- Auto addressing for reliable and quick installation

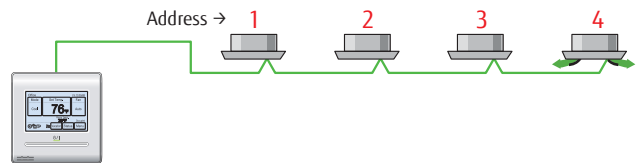

Easy Maintenance

Operation history saved in the controller



Specifications

Model name	UTY-RNRUZ*
Power source	DC 12V
Dimensions (H x W x D) (in. (mm))	4-3/4 x 4-3/4 x 11/16 (120 x 120 x 20.4)
Weight (oz.(g))	8 (220)

Simple Remote Control

(2-wire) UTY-RSRY / UTY-RHRY (Without operation mode)

(3-wire) UTY-RSKU / UTY-RHKU (Without operation mode)

Compact wired remote control unit provides access to basic functions

- Built-in temperature sensor
- Backlit display
- Simple functions make the controller perfect for hotels, schools, etc.

Max. controllable
16
indoor units

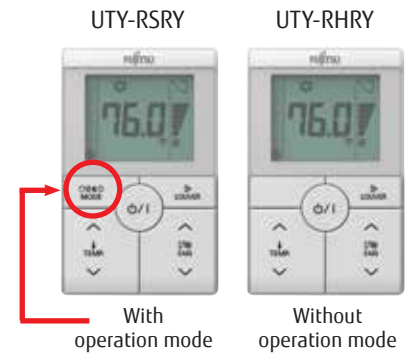

Room temperature set point limitation

Equipped with set point limitation option for energy efficiency.

Vertical louver control

Offers vertical louver control for ducted and cassette units.

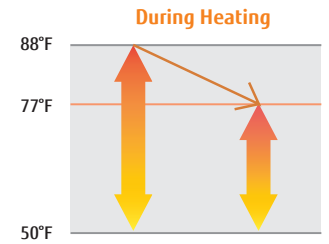
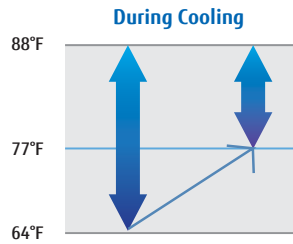
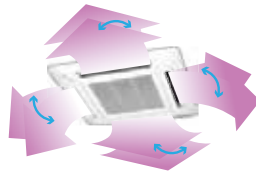
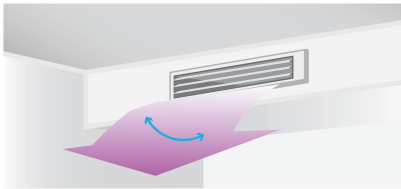

Specifications

Model name	UTY-RSRY	UTY-RHRY
Power Supply	DC 12V	DC 12V
Dimensions (H x W x D) (in. (mm))	4-3/4 x 2-15/16 x 9/16 (120 x 75 x 14)	4-3/4 x 2-15/16 x 9/16 (120 x 75 x 14)
Weight (oz. (g))	4 (120)	4 (120)

DC12V is supplied by the indoor unit.

Wireless Remote Control

UTY-LNHU

Simple and sophisticated operations with a choice of 4 daily timers

- One remote can control up to 16 indoor units.

Accurate and comfortable

Select from 4 different timer programs: On / Off / Program / Sleep
Program timer: The program timer operates the ON and OFF timer once within a 24 hour period.

Sleep timer: The sleep timer function automatically corrects the set temperature according to the time setting to prevent excessive cooling or heating during sleep hours.

Easy installation and operation

- Code selector switch prevents indoor unit mix-up. (Up to 4 codes can be set.)
- Reliable transmitting over long range.
- IR Built-in receiver is standard in compact cassette, ceiling/floor, and wall mounted indoor units.

Max. controllable
16
indoor units

Selectable
4
daily timers



Address setting

During installation, address setting can easily be done using the Wireless Remote Control, thus eliminating manual setting inside the Indoor unit.

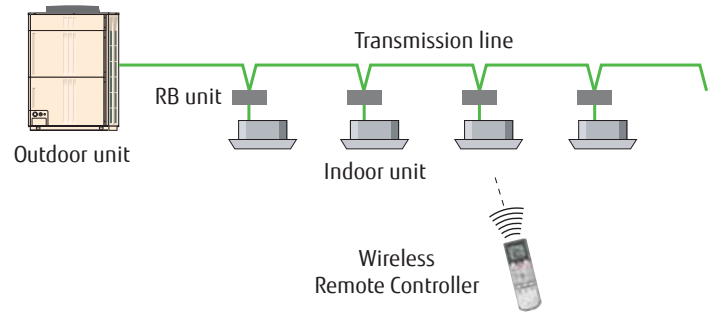

IR Receiver Unit: UTB-YWC (for VRF ducted models)

IR Receiver Unit: UTY-TRHX (for TLAV2 ducted models)

Required for controlling ducted indoor unit via a Wireless Remote Control

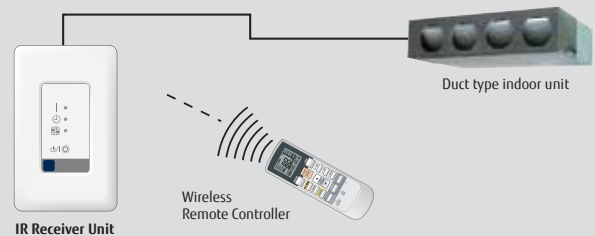

IR Receiver Unit: UTY-LBHxD

Circular Flow Cassette type indoor unit can be controlled with Wireless Remote Control.

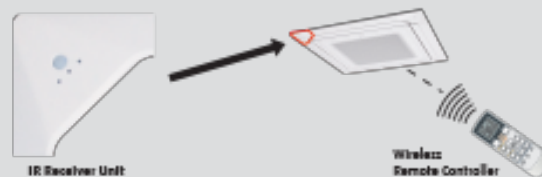

AIRSTAGE Cloud Platform (ASCP) and AIRSTAGE Edge Controller (ASEC)

UTY-DSGYZ2

Multiple system management via the AIRSTAGE Cloud platform subscription

Better solutions for HVAC management and maintenance

The highly versatile AIRSTAGE Cloud platform enables effective and efficient management and maintenance of heating, ventilation, and air conditioning systems. It can be accessed through the AIRSTAGE Edge Controller or a web browser. Note that the AIRSTAGE Edge Controller must be connected to the internet at all times.



Manage HVAC systems for multiple properties

Streamline HVAC management and reduce operating cost

Manage energy usage

Efficiently maintain a comfortable room environment

Enable remote monitoring and maintenance

Improve maintainability and serviceability

New features will be continuously implemented by over-the-air system updates

System Overview

The AIRSTAGE Cloud delivers greater value in operation and life-cycle management of HVAC systems.

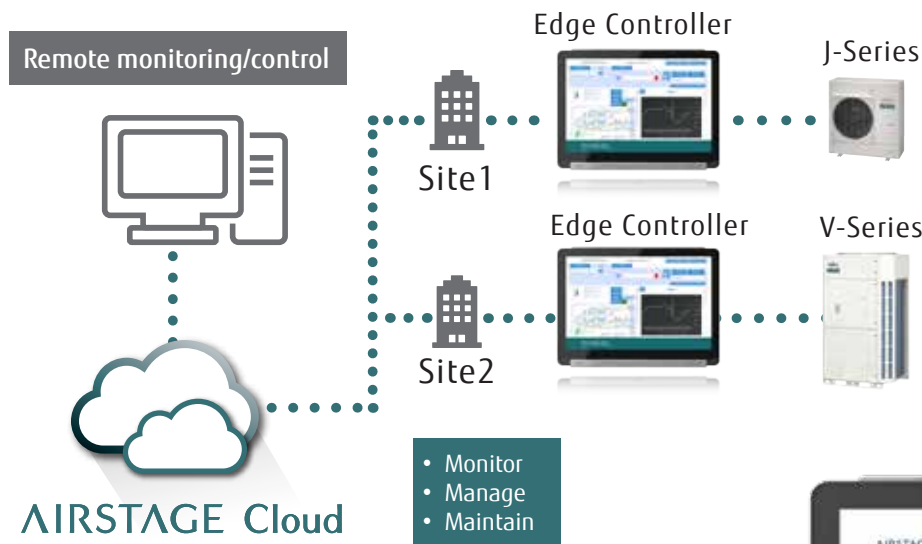

AIRSTAGE Edge Controller (ASEC)

- Stylish look
- Easy-to-read 10.1 inch TFT color wide screen
- Intuitive operation
- Multiple languages supported (English, French, Spanish German, Russian and Polish currently supported; additional languages coming.)



AIRSTAGE Cloud and AIRSTAGE Edge Controller (continued)

Features - Site Manager (SM)

- Manage HVAC systems for multiple properties - Show location map and information about HVAC systems under management
- Streamline HVAC management and reduce operating cost
- At-a-glance monitoring dashboard - Display an HVAC system's operation status and energy usage for each site, group, and system in a dashboard format
- Manage energy usage - Maintain comfortable room environments efficiently

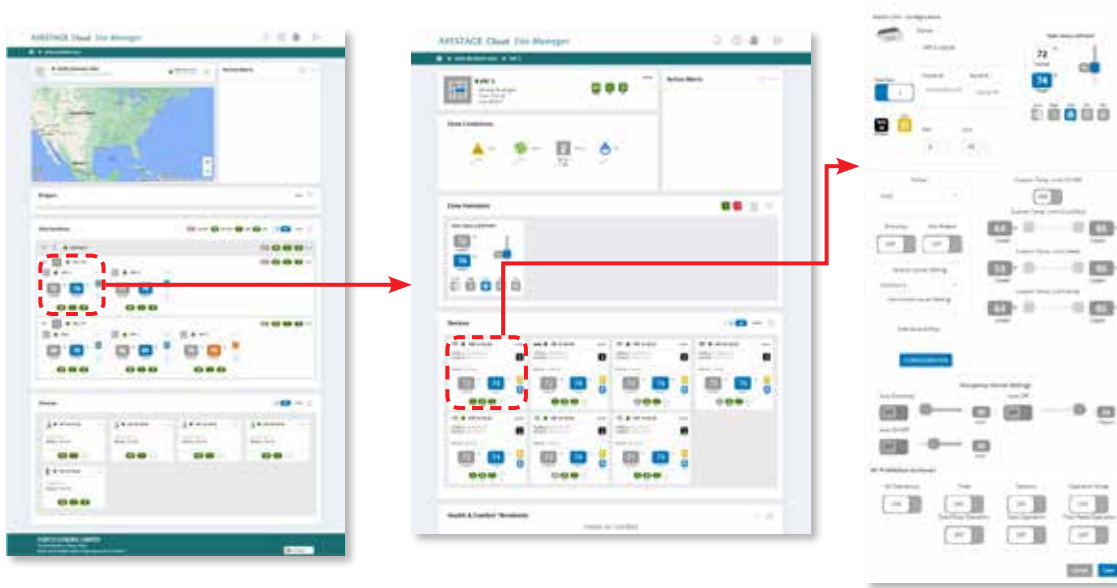

The AIRSTAGE Cloud enables centralized management of HVAC systems operating in multiple properties and plots the property locations on a map. Screen layout and content subject to change as features are added and improved.

Features - Refrigerant Cycle Monitor (RCM)

Refrigerant Cycle Monitor	System List	Display indoor/out unit configuration
		Monitor and control operation
		Special Operation monitoring
	Detail Diagrams (OD/IU)	Current operating parameters
		Piping diagram
		Sensor location and current value
		Trend graphs for temp sensors and EEV pulses
	Detail Status List of operation and sensor values	
	Details Check List showing abnormal values if present	
	Operation History	
Error History		



Features

All functions are available only when connected to the AIRSTAGE Cloud server
 ●: Supported ○: Optional function

Model name		AIRSTAGE Edge Controller
Model number		UTY-DSGYZ2
Max. controllable remote controller groups		128
Max. controllable indoor units		128
Max. controllable zones		128
Air conditioning control function	On / Off	●
	Operation mode setting	●
	Fan speed setting	●
	Room temp. setting	●
	Room temp. set point limitation	●
	Test operation	●
	Up/down airflow direction setting	●
	Left/right airflow direction setting	●
	Individual louver control	●
	Zone (Group) setting	●
	RC prohibition	●
	Anti freeze setting	●
	Economy mode setting	●
	Human sensor control	●
	Custom Auto setting	●
Display	Error display and management	●
	Defrosting	●
	RC prohibition	●
	Cooling/heating priority	●
	Address display	●
	Room temp.	●
	Multi language	6 languages supported *2
	Summer time	●
	Name registration	●
	Backlight	7 brightness levels
Timer	Schedule Timer	Weekly, Yearly
	Period	On/Off, Temp., Mode, Times per day, Low noise*1
	Program timer	●
	Auto off timer	●
	Day off	●
Control	Status monitoring system	●
	Electricity charge apportionment	○*1
	Emergency stop	●
	Remote management	●
	Zone control	●
	Low noise mode	●*1
	Remote maintenance	●*1
Energy management	●*1	
History	Operation	●
	Error	●
Other	Multiple user accounts and access levels	●
	Software Update Over the Air (OTA)	●

*1 : Future release.

*2 : Additional language support will be coming.

Specifications

Item	AIRSTAGE Edge Controller	
Power supply	1φ 100~240VAC 50/60Hz	
Dimensions (H × W × D) (inch[mm])	7-43/64×10-9/32×2-31/64 [195×261×63]	
Weight (lbs[g])	4 [1,900]	
Monitor	10.1" TFT LED-backlit LCD 1280 × 800 pixels 24bit color	
Touch panel	Capacitive touch panel	
Communication	LAN	10BASE-T / 100BASE-TX RJ45 x 2ch
	Wireless LAN	IEEE802.11 b/g/n 2.4GHz
	Others	Modbus RTU x 1ch, AIRSTAGE transmission line x 1ch
External I/O	Input	4ch (Dry contact or Apply voltage)
	Output	2ch
LED	x 1 (Power indication)	
Switch	x 1 (Shut down/Menu)	
Buzzer	Piezo buzzer (3 volume levels)	

Dimensions

Unit : inch [mm]



Subscription Program

Required Hardware: ASEC Controller; one per system

Site Manager: Monthly plan price is per AIRSTAGE Edge Controller

Refrigerant Cycle Manager: Monthly plan price is per Site Manager

See info sheet for more details:



Central Remote Controller

UTY-DCGYZ2

For small- and medium-sized buildings

- Individual control and monitor of 100 indoor units and max. 50 groups
- 7.0inch TFT color screen for high visibility and easy operation
- Supports max.23 different languages
- 12 different languages. (English, Spanish, German, French, Italian, Russian, Portuguese, Turkish, Polish, Greek, Dutch, Chinese)
- Additional language can be integrated by creative language database. *(Bulgarian, Czech, Danish, Estonian, Finnish, Croatian, Hungarian, Romanian, Slovak, Slovenian, Swedish)



Easy operation

- Central remote controller with intuitive operation via touch panel operation
- All functions accessed from the top screen

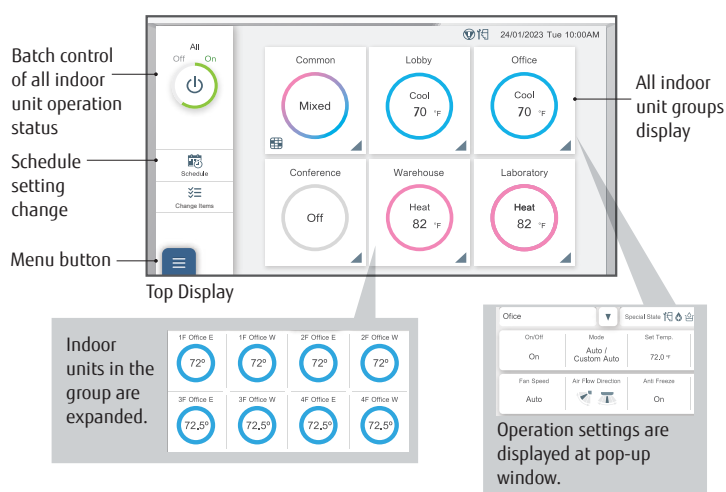

Trouble support function

- Displays operation status details and explanations

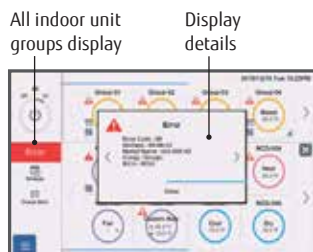

Sensor value monitoring function

Monitor sensor data of indoor unit / outdoor unit, send mail

Notify room temperature by email

Notify by email when the temperature around the air conditioner is out of defined range

Remote monitoring / Remote operation

Central remote controller can control tenant's air conditioner anytime and anywhere.

Example

- Control / Monitoring Fujitsu air conditioner
- Operation status notification by email
- Access to group names

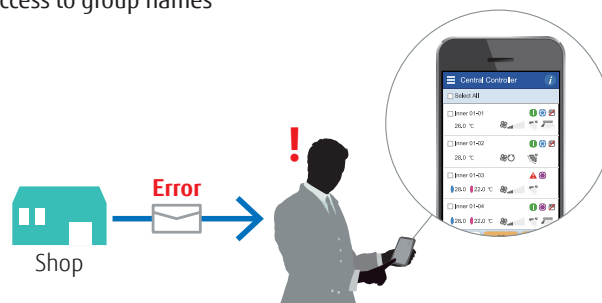

Specifications

Model name`	UTY-DCGYZ2
Power Supply	100-240 V 50/60 Hz
Dimensions (H x W x D) (in.(mm))	5-5/16 x 8-1/2 x 1-1/2 (134.6 x 216.1 x 37.9)
Weight (lbs. (g))	1-21/32 (750)

System Controller Software

UTY-APGXZ1

System Controller provides advanced integrated monitoring & control of VRF network system from small to large buildings

- Up to 4 VRF network systems, 1600 indoor units, and 400 outdoor units can be controlled.
- In addition to air conditioning precision control function, central remote control, electricity charge calculation, schedule management, and energy saving functions are available to meet different needs.



Max. controllable
4
VRF network systems

Max. controllable
400
outdoor units

Max. controllable
1,600
indoor units

System Controller Lite Software

UTY-ALGXZ1

System Controller Lite is designed for small and medium size buildings

- Controls up to a maximum of 1 VRF network system, 400 indoor units, and 100 outdoor units.
- In addition to air conditioning precision control function, a variety of management software add-ons are available as options to meet customers needs.



Max. controllable
1
VRF network system

Max. controllable
100
outdoor units

Max. controllable
400
indoor units

User friendly view and operation

- The building can be viewed and controlled in a 3D click-able perspective view: Four different views are available – site, building, floor, or list view.
- Flexibility to define groups for group control: Indoor units can be freely grouped for simple control from a BMS tree menu. Grouping by hierarchal structure, such as by section, division or department is possible.

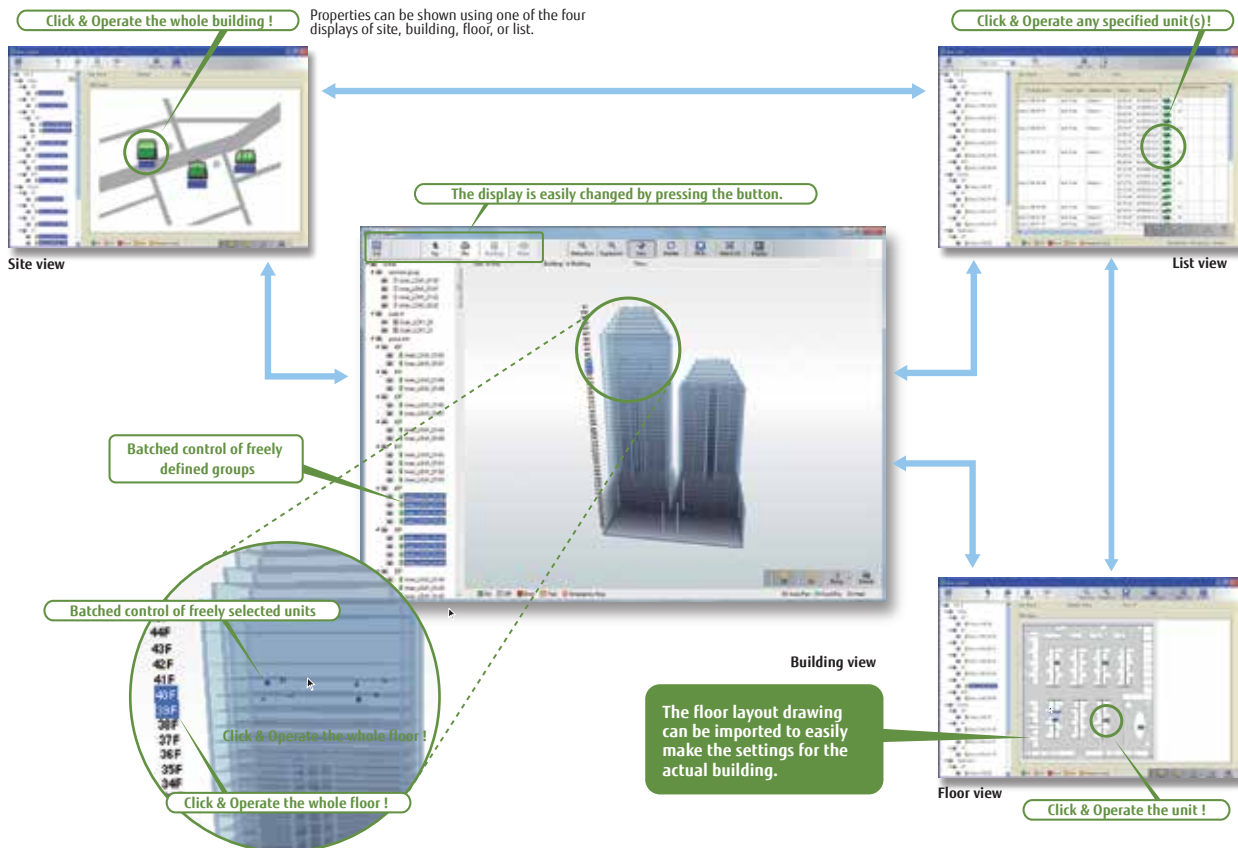

Note:
2D floor layout / 3D building display are not available for System Controller Lite.

System Controller and System Controller Light (continued) Software

Control of 3rd party devices via Modbus

When Modbus Adapter (locally purchased) is connected to system controller PC, the devices connected to the Modbus can be centrally controlled.

Standard for System Controller
Option for System Controller Lite: UTY-PLGXX2

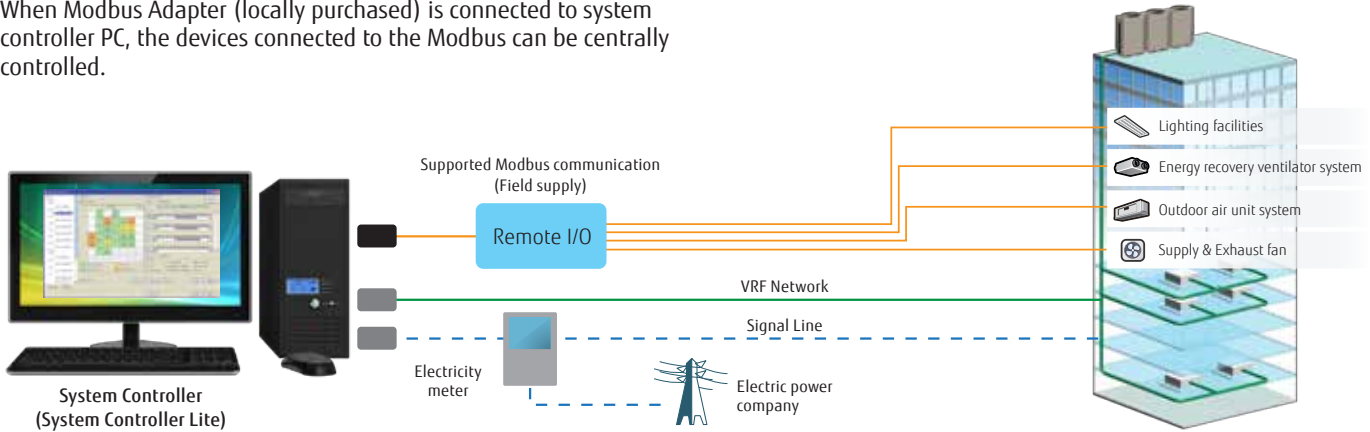

Operation management & Data management

Schedule management

- Annual schedules can be set for each remote control group / user defined group.
- Start / stop, operating mode, disabling of remote control, and temperature settings can be set up to 143 times per day at minimum 10 minute intervals for up to 101 configurations for each remote controller group.
- Allows programming of special settings for holidays, including public holidays, for a complete year.
- Low noise operation of outdoor unit can be scheduled.



Control of indoor unit

- Indoor unit operation state, operation mode, etc. are displayed
- Indoor unit start / stop and operation mode switching
- Room temperature set point limitation

Operation status display & email notification

Operation changes provide popup messages, audible sound and emails. Events for the past year are logged for later review.

Remote control block

This prohibits changes to the operation mode, temperature, start/stop, etc.

Database import/export

Imports/exports registration data, layout data, and image data. Only accessible by administrator.

Automatic clock adjustment

The time setting of each controller can be set in group automatically.

Operating & control record

Displays the history of operation status and control.

Electricity charge allocation

Allocation of monthly cost per tenant for HVAC. The Electricity Charge allocation function determines the share of the total utility bill for each of the tenants. See figure. The detailed calculation takes into consideration unused rooms, nighttime electricity charges, etc.

Standard for System Controller
Option for System Controller Lite: UTY-PLGXA1

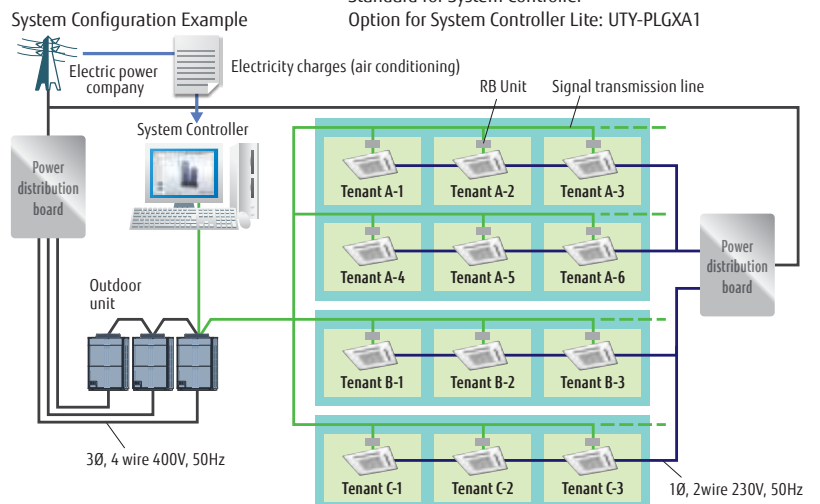

Remote management (Standard for System Controller: UTY-PEGXZ1, Option for System Controller Lite: UTY-PLGXR2)

System Controller may be used on site or remotely over various networks for remote central control. VRF Controller runs on site and communicates with VRF system. VRF Explorer runs remotely and provides user interface and communicates with the VRF Controller. VRF Controller and VRF Explorer programs may run on a single PC or on different PCs. By using VRF Explorer software, one PC can perform central control of 10 VRF system sites with max. 20 buildings per site.

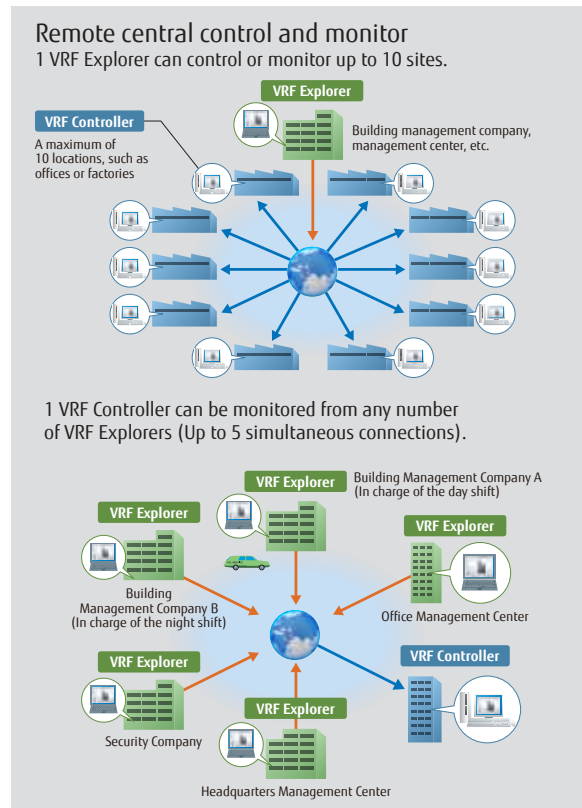
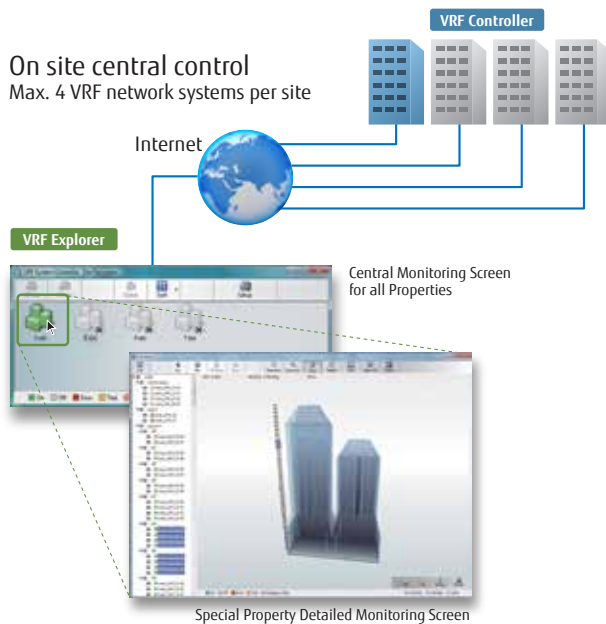

Below are additional options for System Controller: UTY-PEGXZ1 and System Controller Lite: UTY-PLGXR2

Energy saving management

A variety of energy saving operations can be set and managed depending on the season, weather, and time period. Excellent energy saving operation is performed while keeping users comfortable.

Energy saving graph data:
This graph compares the electricity consumption with the previous month and previous year to make it easy to analyze the energy saving effect.



Energy Saving Management Main Screen

Indoor unit rotation operation

The operation of indoor units can be automatically rotated within a group in accordance with the set annual schedule to reduce power consumption while maintaining comfort.

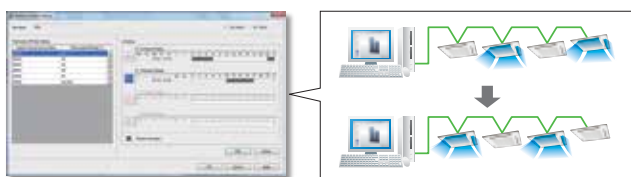

Peak limit operation

To control power consumption and load shedding, the system can be programmed to change the indoor unit set temperature, turn the indoor unit thermostat off, or adjust other parameters to carefully control the amount of power consumed while maintaining comfort.

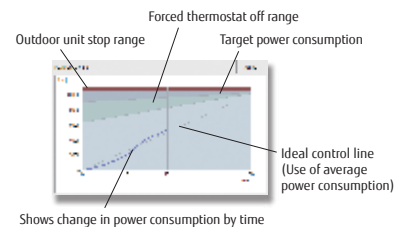

Outdoor Unit Capacity Save

The function 'Outdoor Unit Capacity Save', switches the outdoor unit capability upper limit to suppress power consumption during hot summers and cold winters by averaging the power saving effect of each refrigerant system. Function can be applied for 50% or more of the upper capacity limit.

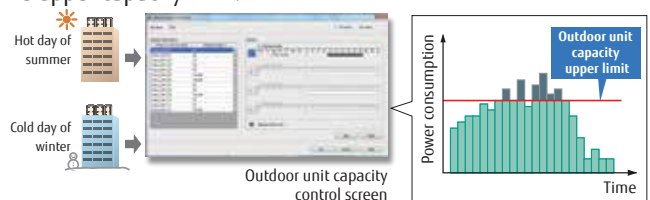

Functions summary

Function	Type	System controller		System controller lite				
		UTY-APGXZ1	Option UTY-PEGXZ1	UTY-ALGXZ1	Option UTY-PLGXR2	Option UTY-PLGXA2	Option UTY-PLGXE2	Option UTY-PLGXX2
System specification	Max. VRF networks supported	4	—	1	—	—	—	—
	Max. indoor unit / remote controller groups per VRF network	400	—	400	—	—	—	—
	Max. outdoor units per System controller	100	—	100	—	—	—	—
	Max. indoor units / remote controller groups per System controller	1600	—	400	—	—	—	—
Site supervision	Max. outdoor units per System controller	400	—	100	—	—	—	—
	Multi site display	10	—	10	—	—	—	—
	Number of building / 1 site	20	—	—	—	—	—	—
	Number of floor per 1 site	200	—	—	—	—	—	—
	Number of floor per 1 building	50	—	—	—	—	—	—
	3D graphical layout view	●	—	—	—	—	—	—
	2D graphical layout view	●	—	—	—	—	—	—
	List display	●	—	●	—	—	—	—
	Tree display	●	—	—	—	—	—	—
	Group display	●	—	—	—	—	—	—
Error management	Error notification	●	—	●	—	—	—	—
	Audible alarm	●	—	●	—	—	—	—
	Error email notification	●	—	—	—	—	—	—
History	Error history	●	—	●	—	—	—	—
	Operation history	●	—	●	—	—	—	—
	Control history	●	—	●	—	—	—	—
Operation control	Individual control	On/Off	●	—	●	—	—	—
		Operation mode	●	—	●	—	—	—
		Room temperature	●	—	●	—	—	—
		Fan speed	●	—	●	—	—	—
		Air flow direction	●	—	●	—	—	—
		Economy mode	●	—	●	—	—	—
		Room temperature set point limitation	●	—	●	—	—	—
		Test operation	●	—	●	—	—	—
		Antifreeze	●	—	●	—	—	—
		Outdoor unit low noise setting	●	—	●	—	—	—
	Individual management	Remote control prohibition setting	●	—	●	—	—	—
		Temperature upper and lower limit setting	●	—	●	—	—	—
		Filter sign reset	●	—	●	—	—	—
	Other	Memory operation	●	—	●	—	—	—
		Pattern operation	●	—	●	—	—	—
Schedule	Annual Schedule	●	—	●	—	—	—	
	Special day setting	●	—	●	—	—	—	
	On / off per day	72	—	72	—	—	—	
	On / off per week	504	—	504	—	—	—	
	Day off	●	—	●	—	—	—	
	Min. unit of timer setting (Minutes)	10	—	10	—	—	—	
	Low noise mode Weekly schedule	●	—	●	—	—	—	
Remote management	Remote monitoring	●	—	—	●	—	—	
	Remote operation control	●	—	—	●	—	—	
	Remote function setting	●	—	—	●	—	—	
	Web Remote Controller	●	—	—	●	—	—	
Electricity charge apportionment	Apportionment charge/bill calculation	●	—	—	●	—	—	
	Tenant (block) setting	●	—	—	●	—	—	
	Common facilities apportionment setting	●	—	—	●	—	—	
	Rated power consumption allotment setting	●	—	—	●	—	—	
	Individual calculation at cooling and heating	—	●*	—	—	●	—	
	Electricity meter supported	—	●	—	—	●	—	
Energy saving management	Indoor unit rotation	—	●	—	—	●	—	
	Peak cut control	—	●	—	—	●	—	
	Outdoor unit capacity save	—	●	—	—	●	—	
	Record of energy saving operation	—	●	—	—	●	—	
	Energy saving information	—	●	—	—	●	—	
	Power consumption monitor	—	●	—	—	●	—	
External Device Control	Monitor	●	—	—	—	—	●	
	Control	●	—	—	—	—	●	
Others	Database import/export	●	—	●	—	—	—	
	Automatic clock adjustment	●	—	●	—	—	—	
	Multi language	7 languages	—	7 languages	—	—	—	

● : Available. — : Not available.

*:Power calculation application software is necessary, please contact the local Fujitsu representative.

Computer system requirements:

Model name	System Controller	System Controller Lite
Operating system	<ul style="list-style-type: none"> Microsoft Windows 7 Home Premium (32-bit or 64-bit) SP1 Microsoft Windows 8.1 (32-bit or 64-bit) Microsoft Windows 10 Home (32-bit or 64-bit) 	<ul style="list-style-type: none"> Microsoft Windows 7 Professional (32-bit or 64-bit) SP1 Microsoft Windows 8.1 Pro (32-bit or 64-bit) Microsoft Windows 10 Pro (32-bit or 64-bit)
CPU	Intel® Core™ i3 2 GHz or higher	
Memory	• 2 GB or more (for Windows Vista® and Windows® 7 [32-bit])	• 4 GB or more (for Windows® 7 [64-bit], Windows® 8.1, and Windows® 10)
HDD	40 GB or more of free space	
Display	1024 x 768 or higher resolution	
Interface	<ul style="list-style-type: none"> Ethernet port (for getting access to the Internet using LAN) or Modem (for getting access to the Internet using public telephone line) USB ports (Maximum of 5 ports) (Required only for the server PC that works as VRF controller) – Maximum of 1 USB ports are required for WHITE-USB-KEY connection – Maximum of 4 USB ports are required for Echelon U10 USB Network Interface NOTE: Maximum number of required USB ports depends on the applicable system configuration. 	<ul style="list-style-type: none"> Ethernet port (for getting access to the Internet using LAN) or Modem (for getting access to the Internet using public telephone line) USB ports (Maximum of 2 ports) (Required only for the server PC that works as VRF controller) – 1 USB port is required for WHITE-USB-KEY connection – 1 USB port is required for Echelon U10 USB Network Interface NOTE: Maximum number of required USB ports depends on the applicable system configuration.
Graphic accelerator	Microsoft® DirectX® 9.0c compatible	
Software	Adobe® Reader® 9.0 or later	

• Personal computer that satisfies the following system requirements

• Echelon® U10 USB Network Interface – TP/FT-10 Channel (Model number: 75010R) (Required for each VRF network)

Packing list	For System controller			For System controller Lite			
	System controller	Option Energy manager	System Controller Lite	Remote access	Electricity charge apportionment	Energy saving	Central Control
Model name	UTY-APGXZ1	UTY-PEGXZ1	UTY-ALGXZ1	UTY-PLGXR2	UTY-PLGXA2	UTY-PLGXE2	UTY-PLGXX2
WHITE-USB-KEY	1	1	1	1	1	1	1

Software protection key to be inserted in a USB slot running System Controller or System Controller Lite.

System Controller or System Controller Lite may only run on a PC with WHITE-USB-KEY. However, WHITE-USB-KEY is not required for remote VRF Explorer software.

AIRSTAGE Integration Manager™

powered by
niagara
framework®

FUJ-VRF-8025

FUJ-VRF-8125



Bundle includes: JACE 8000, Lon adapter, VRF driver for up to 25 or 125 total ODU + IDU, power adapter, 5 years software maintenance

Fujitsu is proud to announce an all-new hardware platform optimized for the Niagara Framework by Tridium Inc. – the AIRSTAGE Integration Manager™ (powered by Niagara). This “next-generation” controller is a dramatic evolution in integrating AIRSTAGE systems worldwide, featuring a new global design that functions with legacy systems and has the ability to scale for future needs.

The AIRSTAGE Integration Manager™ (powered by Niagara) is a compact controller and integration platform for connecting AIRSTAGE equipment and devices to any commercial Building Management System (BMS). The AIRSTAGE Integration Manager controller not only provides seamless BMS integration, it includes a guided configuration tool, basic monitoring and control functions, an alarm console, and cloud-based access (through a standard web browser via Ethernet or wireless LAN, or remote over the internet).

The licensing model for the AIRSTAGE Integration Manager controller is simple, and features native AIRSTAGE and standard open-protocol drivers, including BACnet, LonWorks, and Modbus. Optional IO and field bus expansion modules provide ultimate flexibility and expandability. The AIRSTAGE Integration Manager controller operates with Niagara 4, the latest version of the Niagara Framework, for optimum performance. In larger facilities, multi-building applications and large-scale control system integrations, Niagara 4 Supervisors can be used with AIRSTAGE Integration Manager controllers to aggregate information, including alarms and historical and real-time data, to create a single unified application.

System Diagram:

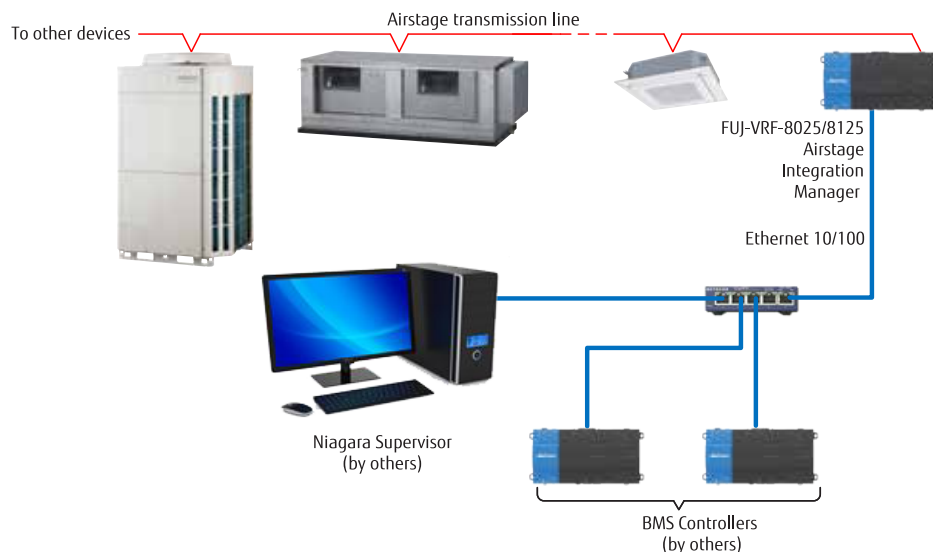

Efficient Global Design

The new, modular design of the AIRSTAGE Integration Manager controller makes it easy to install, integrate and deploy. Tool-less installation with expansion capability reduces installation complexity and improves flexibility. Systems integrators can focus on engineering solutions, not assembling components.

Key Features

Intuitive User Interface - Configuration and control software is custom-designed for AIRSTAGE systems. No experience with the Niagara platform is necessary. Users can easily check system status by glancing at the front panel LEDs to diagnose network issues.

Global Capacity Licensing and Upgrade Capability - The controller is purchased pre-licensed for 25 or 125 AIRSTAGE devices (indoor + outdoor units). Device license upgrades, in increments of 50, can be purchased in the future as your needs grow.

Modular Design For Easy Installation And Expansion - The LonWorks® module for AIRSTAGE connection is included. Up to 4 option modules directly attach to the controller for on board IO or additional communications ports, including types for LonWorks®, RS232 and RS485 networks. Controller and option modules are designed for easy mounting on a 35mm-wide DIN rail.

Global Power Compatibility - 24VAC or 24VDC power source. 120/24V power supply with adapter plugs included.

5-year Software Maintenance Agreement Included - Your Niagara software is protected with free updates to the latest Niagara versions. No need to worry about security patches or compatibility with other Niagara devices.

AIRSTAGE Integration Manager (continued)

Hardware specifications

TI AM3352: 1000MHz ARM® Cortex™-A8

1GB DDR3 SDRAM

Removable micro-SD card with 4GB flash total storage/2GB user storage

USB type A connector

Back-up and restore support

(2) isolated RS-485 with selectable bias and termination

(1) LonWorks FTT-10A expansion module included (for connection to AIRSTAGE transmission line)

(2) 10/100MB Ethernet ports

Secure boot

Supply requirements: 24VAC rated at 24VA minimum, or 24VDC rated at 1A (24W) minimum; a 120/24V wall adapter is included

Runs Niagara 4: 4.10

Real-time clock

Batteryless

Niagara Analytics 2.1 is compatible with Niagara 4.4 and 4.6

Real-time clock

JACE® 8000 controller Mounting & Dimensions

- 1 JACE 8000 controller. Allow at least 1.5" (38mm) clearance around all sides
- 2 Expansion module. Up to four (4) may be used. See "Expansion Module and IO Configurations"
- 3 Distances between center of tabs from one unit to another unit

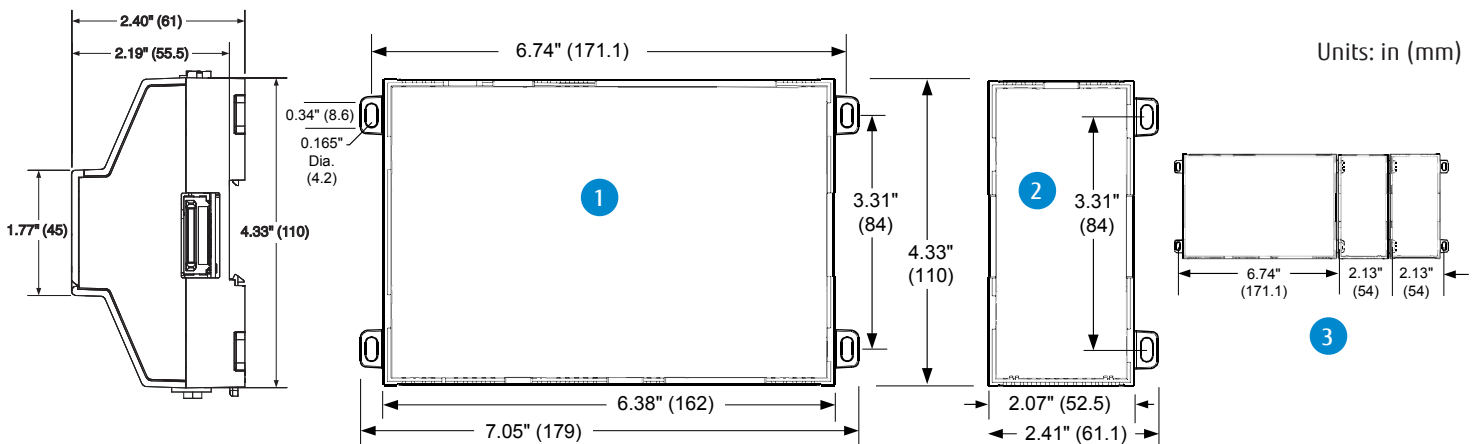

Compatible with (DIN43880) enclosures

Suitable for mounting to a panel or to an EN50022 standard 35mm rail

VRF	Compatible models	V-II / VR-II/ J-IVS / J-IV / J-IIIL
	Max. number of units	up to 125 OU+IU per JACE
	Max. number of VRF networks	1 per Lon adapter, up to 4 Lon adapters per JACE, depends on the license used
	Interface	JACE 8000: Lon adapter PC: Ethernet 10/100Mb port
Niagara	Version	Niagara 4.9
	Max. Points	about 20,000, depends on the license used

BACnet® Gateway (Hardware)

UTY-VBGX

BACnet® Gateway connects a VRF system to a BMS via BACnet® IP.

- A maximum of 128 indoor units and 32 refrigerant systems can be connected to a single BACnet® Gateway.
- Compatible with BACnet® (ANSI / ASHRAE-135-2012) application specific controller (B-ASC).
- Compatible with BACnet®/IP over Ethernet.

Max. controllable
1
VRF network system

Max. controllable
32
outdoor units

Max. controllable
128
indoor units



Installation example

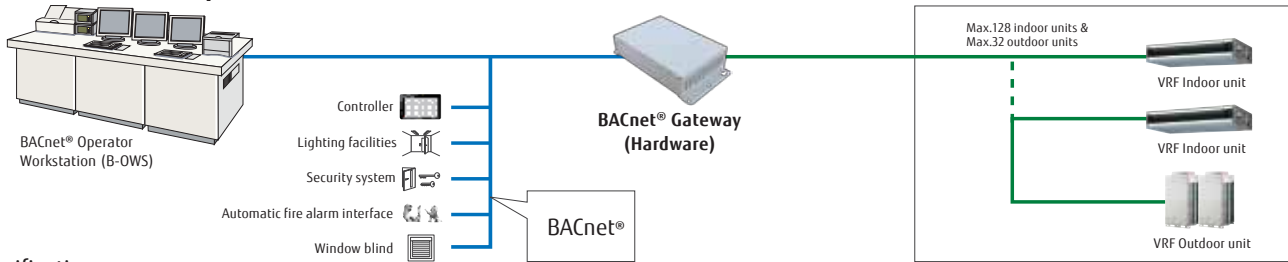

Specifications:

Model name	UTY-VBGX
Number of controllable indoor units	128
Number of controllable refrigerant system	32
Number of controllable VRF networks	1
Number of connectable Gateways / one VRF network	4

Model name	UTY-VBGX
Power supply	208-240V 50/60Hz, single phase
Input power (W)	4
Dimensions (H x W x D) (in.(mm))	10-1/4 x 2-5/16 x 5-11/16 (260 x 59 x 145)
Weight (lbs.oz.(g))	39oz (6100)

BACnet® Gateway

UTY-ABGXZ1 **Software**

Max. controllable
4
VRF network systems

Max. controllable
400
outdoor units

Max. controllable
1600
indoor units



BACnet® Gateway connects a VRF system to a BMS via BACnet® IP.

- Up to 1600 indoor units with 4 VRF network systems (a maximum of 400 indoor units & 100 outdoor units for one network system) can be connected to one BACnet® Gateway.
- Compatible with BACnet® (ANSI / ASHRAE-135-2012) application specific controller (B-ASC).
- Compatible with BACnet®/IP over Ethernet.
- Scheduling function, Alarm & Event functions as well as as Electricity Charge allocation function is provided in BACnet® Gateway.
- Requires dedicated PC with Windows 7, 8, or 10 (32-bit or 64-bit); Ethernet adapter; up to 5 available USB ports: 1 USB port is required for WHITE-USB-KEY connection; maximum of 4 USB ports are required for Echelon® U10 USB LonWorks Adapter.
- Windows PC and Echelon adapter are field-supplied items.
- Supports 7 different languages: English, Chinese, French, German, Spanish, Russian, Polish.

BACnet® Gateway

FJ-AC-485-1 **One-to One**

Connects one VRF indoor unit to a BMS via BACnet MSTP.

- Connects to the AIRSTAGE indoor unit's UART port (CN65) with a supplied interface cable.
- Compatible with the BACnet MSTP protocol over RS485
- Simple configuration from onboard DIP switches (no software tools required).
- Simultaneous control of the indoor unit by a Fujitsu remote controller and the BMS.
- Total control and monitoring of the AC unit from the BMS using the indoor unit's internal variables including dual heat/cool setpoints, run time counter, error indication and more



Network Converter for LONWORKS®

UTY-VLGX

Connects VRF network system to a BMS network via LONWORKS® open network.

- Easy-to-use PC-based configuration software
- The UTY-VLGX enables central monitoring and control of a VRF network system from a BMS through a LONWORKS® FTT-10A interface.
- Up to 128 Indoor units can be connected to one Network Converter for LONWORKS®

Control up to **4** units to one BMS

Max. controllable **100** outdoor units

Control up to **100** outdoor units



Installation example

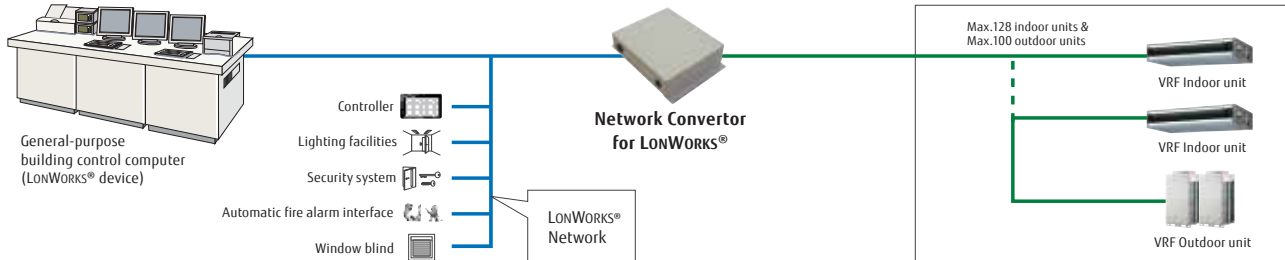

Specifications

Model name	UTY-VLGX
Power Supply	208-240V 50/60Hz, Single phase
Input power (W)	4.5
Dimensions (H x W x D) (in.(mm))	2-5/8 x 11-5/16 x 8-5/16 (67 x 288 x 211)
Weight (lbs.oz.(g))	3lbs. (1,500)

Transmission specifications (BMS side)

Transmission speed	78 kbps
Transceiver	FT-X1 (Echelon® Corporation)
Transmission way form	Free topology
Terminal resistor	None (It attaches at the terminal of a network.)

MODBUS® Converter

UTY-VMGX

VRF System can be integrated with a building management system supported by MODBUS® RTU

Control up to **9** units to one BMS

Control up to **100** outdoor units

Control up to **128** indoor units



Installation example

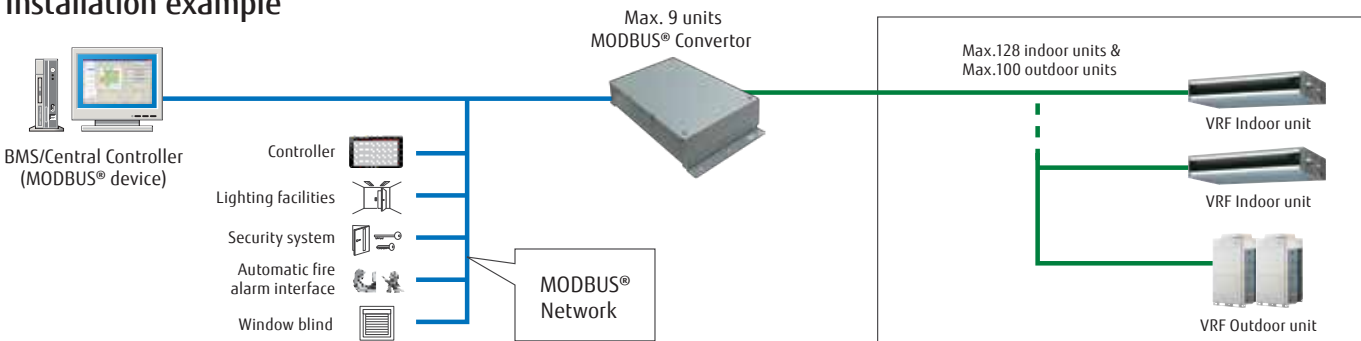

Specifications

Model name	UTY-VMGX
Power Supply	AC220/240V 50/60Hz AC208/230V 60Hz
Input power (W)	Max. 3
Dimensions (H x W x D) (in.(mm))	9-1/4 x 4-3/4 x 1-3/4 (235 x 120 x 45)
Weight (lbs.oz.(g))	39 oz. (1,100)

Wi-Fi Interface Modules

UTY-TFSXJ4

for indoor units with UART port; uses AIRSTAGE Mobile app 

FJ-AC-WIFI-1

for indoor units with UART port; uses AC Cloud Control App 

FJ-RC-WIFI-1NA

for 3-wire indoor units; uses AC Cloud Control App 

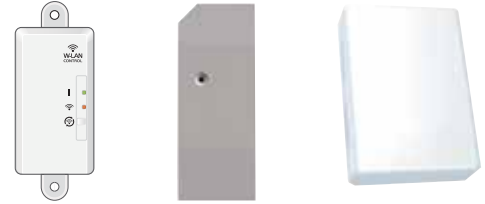

For: Cassettes, Ducted Units, Ceiling Mount, Floor/Ceiling Mount (Universal), Wall Mounted, Floor Mount Units

AIRSTAGE Mobile

Control, simplified

Clean interface enables effortless system management.

AIRSTAGE Mobile unique features:

- The air conditioner and the app can also be connected for direct control without a wireless access point
- Outdoor and Room Temperature display
- Group functions for monitoring and on/off control of the group
- User access levels
- Specialty functions, if available on your system, include: Economy, Energy Saving Fan, Occupancy, Powerful, and Outdoor Unit Low Noise



Home screen



Mode change



Fan speed change



Weekly timer

AIRSTAGE Mobile app and adapter

Compatible V-Series, J-Series models: All TLAV2 models.

Control your Fujitsu AIRSTAGE VRF indoor unit from anywhere over Wi-Fi, using a smartphone, tablet or PC¹ via the Internet.

How does it work?

- The indoor units are controlled from an intuitive, user-friendly interface.
- A wired device installed near each unit controls its operation and communicates over Wi-fi to the Internet router.
- A server in the cloud manages the whole process.

Features (AIRSTAGE Mobile app and AC Cloud Control app)

- Manages the VRF indoor unit using the iOS or Android app.
- Programming of the indoor unit operation schedule.
- Offers access to several indoor unit settings including Mode, Temperature Set Point, Fan Speed, and much more.
- Room Temperature Display.
- Offers early startup function to bring the space to desired set point prior to being occupied.
- Offers delayed setback after leaving.
- Provides instant alarm notifications.
- Operation status reporting, available in several languages
- Over-the-air updates

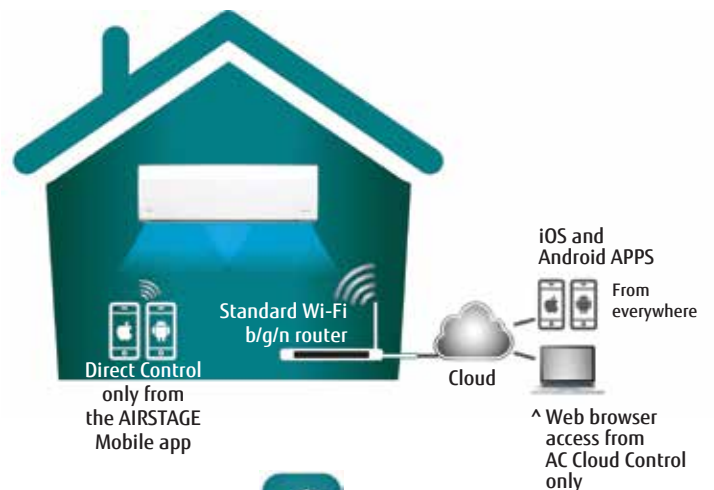

AC Cloud Control App



Network Converters

UTY-VTGX (DC power supply)

UTY-VGGXZ1 (AC power supply)

Network Converters add Fujitsu mini-split control to the VRF communication network

Max. controllable
16
single indoor units

Max. controllable
100
Network Converters



UTY-VTGX
DC power supply



UTY-VGGXZ1
AC power supply

Installation example

- The converters are required when connecting single split units to the VRF communication network system. Both VRF system and single splits can be managed using the VRF central controller.
- See Network Converter submittal for Halcyon indoor unit model compatibility.

Single split with VRF

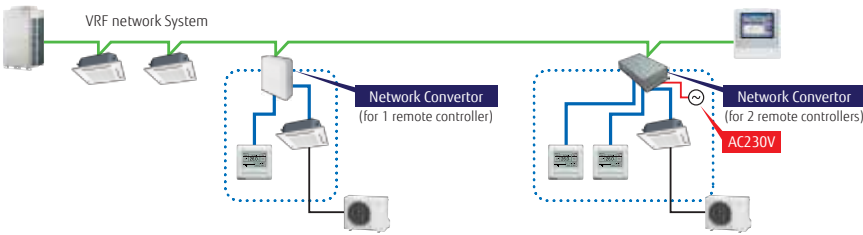

Specifications

Model name	UTY-VTGX		UY-VGGXZ1
Power Supply	polar 3-wire DC12V	non-polar 2-wire DC12V	220-240 V 50/60 Hz
Input power (W)	Max. 2		Max. 3
Dimensions (H x W x D) (in.(mm))	4-5/8 x 5-1/2 x 1-9/16 (117 x 140 x 40)		2 x 10 x 6 (54 x 260 x 150)
Weight (oz.(g))	9 (250)		38.8 (1,100)

Signal Amplifier

UTY-VSGXZ1

- Communication Line length can be extended up to 11,811ft. (3,600m) with multiple Signal Amplifiers.
- Up to 8 signal amplifiers can be installed in a single VRF communication network system.
- A signal amplifier is required
 - When the total wiring length of the communication line exceeds 1,640ft. (500m).
 - When the total number of units on the communication line exceeds 64.



Installation example

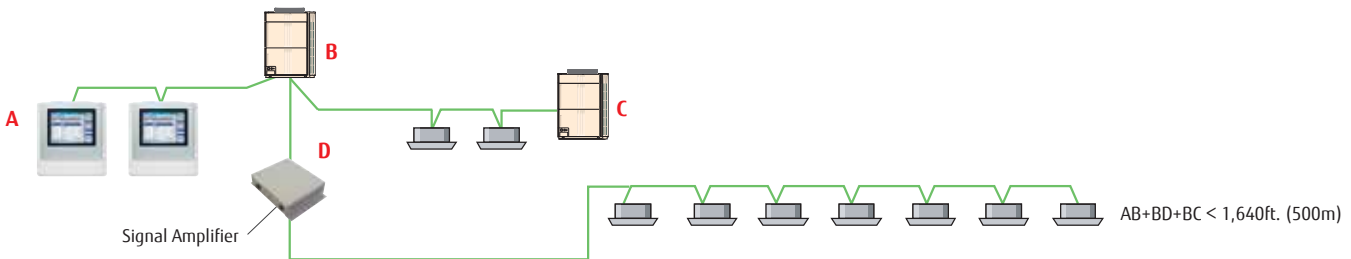

Specifications

Model name	UTY-VSGXZ1
Power Supply	208-240V 50/60Hz, Single phase
Input power (W)	4.5
Dimensions (H x W x D) (in.(mm))	2-5/8 x 11-5/6 x 8-5/16 (67 x 288 x 211)
Weight (lbs.oz.(g))	3lbs. (1,500)

External Switch Controller

UTY-TERX



Air conditioner operation can be controlled by connecting external sensor switches

- Very suitable for hotel rooms and similar. Input from external devices such as card-keys, temperature sensors, occupancy sensors, etc. can be used to control ON/OFF, Room temperature, Fan speed and other Master control functions.

Flexibility with possibility to set different temperatures for cooling and heating

Occupancy sensors can be used to setback temperature and fan speed when room is unoccupied. These setbacks are reverted when room becomes occupied again.

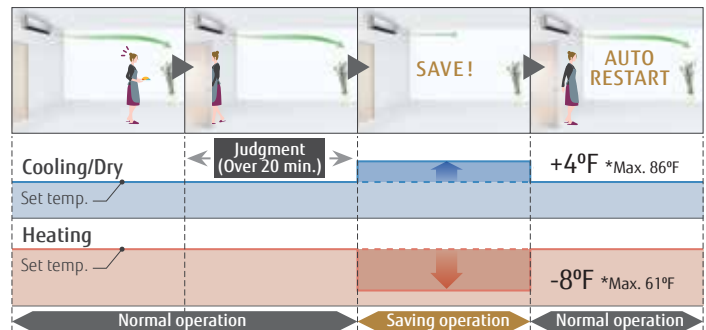

Functions

On/Off	•
Off	•
Room temperature setting	•

Fan speed setting	•
Operation mode setting	•
Prohibition setting	•

System overview

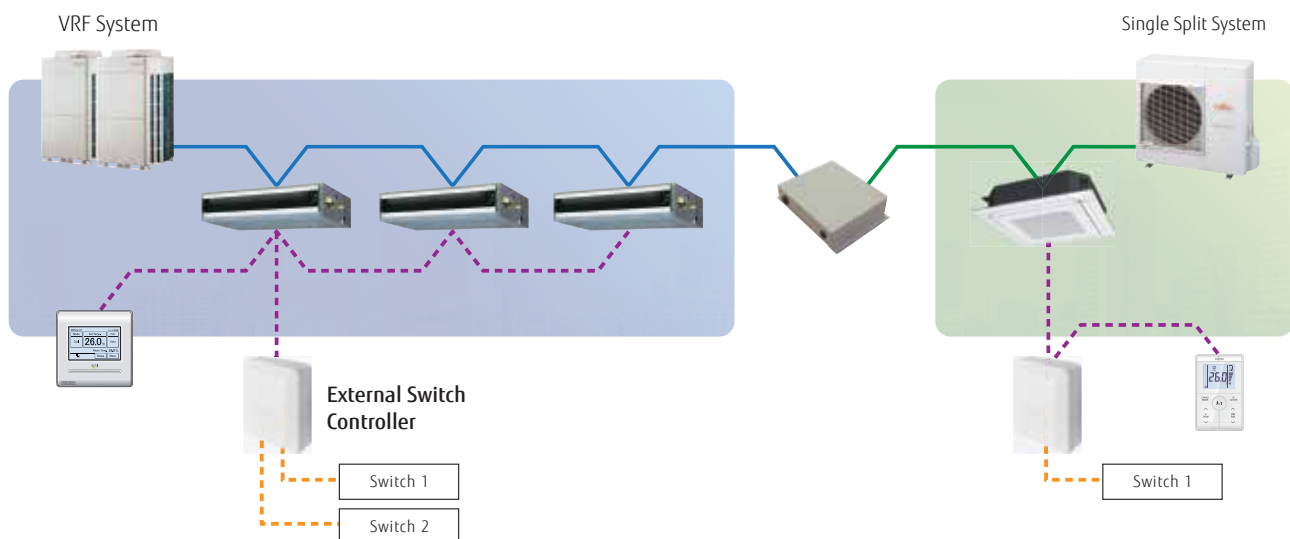

Specifications

Model name	UTY-TERX
Power Supply	DC6.5 - 16V
Dimensions (H x W x D) (in. (mm))	1-11/16 x 5-1/2 x 4-5/8 (43 x 140 x 117)
Weight (lbs.oz. (g))	9 oz. (250)

DC12V is supplied by the indoor unit.

3rd Party Thermostat Interface

UTY-TTRXZ1, TTRXZ1-KIT



The Thermostat Interface enables 3rd party conventional or smart thermostats to be used in the AIRSTAGE VRF system

TTRXZ1-KIT

Includes the most commonly used parts needed to install a UTY-TTRXZ1 Third Party Thermostat Interface. TTRXZ1-KIT Includes:

- (1) UTY-TTRXZ1 Third Party Thermostat Interface
- (1) VPL24-210V Transformer
- (1) UTY-WIFI Plug

UTY-TTRXZ1 Functions

Unit Control Features	ON/OFF
	Temperature Setpoint (from 3rd party thermostat)
	One- or Two-stage Heating/Cooling
	Heating/Cooling Response Adjustment
	Delay OFF Adjustment
Service/Maintenance	Fan Speed
	Error notification via LED lights

Example

Serial Communication Remote control line Thermostat Wire VRF Network (Lon Works)

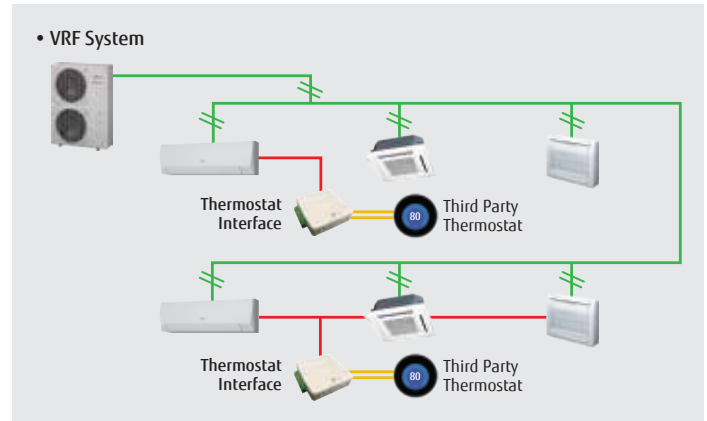

Maximum Wire Lengths

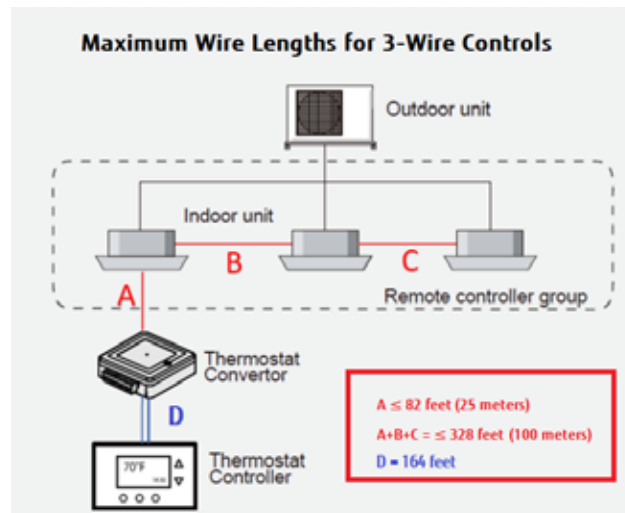
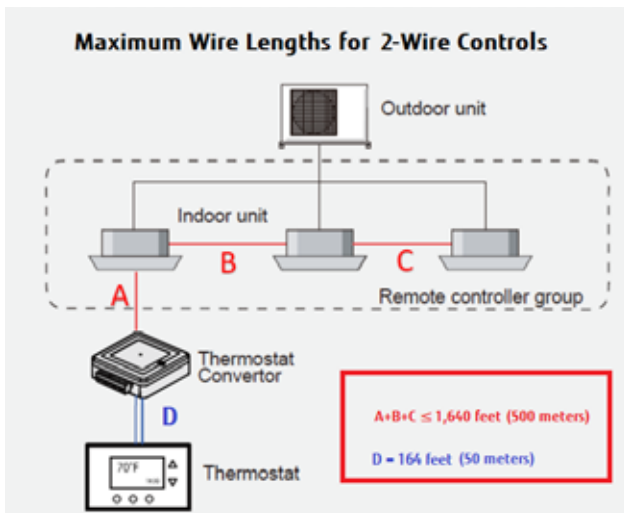

24V transformer (sold separately or included in TTRXZ1-KIT)

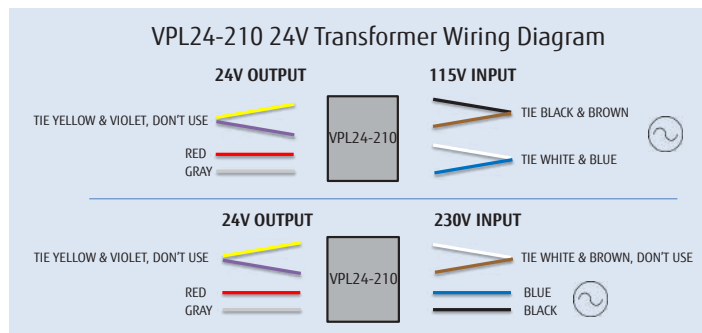

UTY-TTRXZ1 comes pre-set for 2-wire controls. For 3-wire systems, remember to change "Set 1" to 3-wire mode.

Specifications

Model Name	UTY-TTRXZ1
Max. Connectable Indoor Units	16
Input Power Max.	0.6 W
Dimensions (HxDxW)	1-1/16 × 3-7/16 × 3-7/16 in. (27 × 86.7 × 86.7 mm)
Weight	7.8 in. (220 g)

Service Tool Kit

UTY-ASGXZ1-KIT Software

UTY-ASGXZ1-KIT = UTY-ASGXZ1 + Echelon Adapter 75010R-U10

Monitor and control up to
400
indoor units

Monitor and control up to
100
outdoor units



Extensive monitoring and analysis functions installation, maintenance, and system status analysis

- Operation status can be checked and analyzed in detail
- Offer secure remote monitoring and control
- Storage of data on system operation status on a PC allows remote access.
- Up to 400 indoor units (a single VRF network system) can be controlled and monitored for large-scale buildings or hotels
- This software can be connected to any point of transmission line with included Echelon USB adapter

Automatic operation check

Time saving automatic self-diagnosis of system operation with detailed report of status and condition.



[Note] Use only as a guide and judge for yourself finally.

Whether each sensor value is normal is judged automatically.

- Discharge temperature normal value **OK**
 - Super heat volume normal value **OK**
 - High pressure pipe normal value **OK**
 - Low pressure pipe normal value **OK**
- ...etc.



Remote technical support & maintenance

Efficient tech support with online chat function, on-site check screen that can be shared remotely or in real time on site.

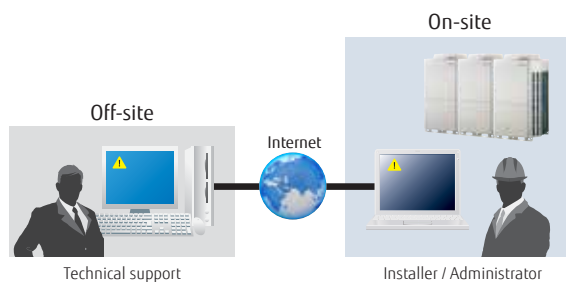

Multiple trend graph display and comparison

- Multiple graphs can be displayed in Service Tool as required
- Two offline data files can be viewed and compared simultaneously



Personal computer system requirements:

Model name	UTY-ASGXZ1-KIT	
Operating system	<ul style="list-style-type: none"> • Microsoft® Windows® 7 Professional (32-bit or 64-bit) SP1 • Microsoft® Windows® 8.1 Pro (32-bit or 64-bit) • Microsoft® Windows® 10 Pro (32-bit or 64-bit) 	
CPU	1 GHz or higher	
Memory	<ul style="list-style-type: none"> • 1 GB or more (for Windows Vista®, Windows® 7 [32-bit], Windows® 8.1 [32-bit], and Windows® 10 [32-bit]) • 2 GB or more (for Windows® 7 [64-bit], Windows® 8.1 [64-bit], and Windows® 10 [64-bit]) 	
HDD	40 GB or more of free space	
Display	1366 x 768 or higher resolution	
Interface	<ul style="list-style-type: none"> • 2 USB ports - 1 USB port is required for software protection key connection - 1 USB port is required for Echelon® U10 USB Network Interface 	
Software	Internet Explorer® 11 or Microsoft Edge / Adobe® Reader® 9.0 or later	

Packing List	Quantity	Application
WHITE-USB-KEY (Software protection key)	1	Software protection key to be connected to USB port on the Service Tool-installed PC. These products runs only on a PC with WibuKey.

- Personal computer that satisfies the following system requirements
- Echelon® U10 USB Network Interface – TP/FT-10 Channel (Model number: 75010R) (Required for each VRF Network.)

Service Tool UTY-ASGXZ1-KIT (continued)

Functions

The screenshot shows a web-based interface for a VRF system. At the top, there are navigation tabs: 'System List', 'Draw', 'History', 'Error History', 'Control', and 'Others'. Below the tabs, there are buttons for 'Print' and 'Option', and a status indicator for 'Indoor (00-00)' and 'Outdoor (01-00)'. The main content is a table with the following columns: Ref, Unit, R/C, Phase, Model, Type, Capacity (RTT/HA), Setpts, Operstat, Mode, Set Temp (°C), F.Oder Temp (°C), R.E.I. In (°C), R.E.I. Out (°C), RPY (P), Error, Signal, Operstat, and P.

Ref	Unit	R/C	Phase	Model	Type	Capacity (RTT/HA)	Setpts	Operstat	Mode	Set Temp (°C)	F.Oder Temp (°C)	R.E.I. In (°C)	R.E.I. Out (°C)	RPY (P)	Error	Signal	Operstat	P
00	00			Out	Heat Pump	-	-	ON	Idling	-	-	-	-	-	Normal	-	-	-
	00			In	Wall Mounted	3000	1B	ON	Cool	26	0	16	16	1600	Error2	-	-	Act
01	00		L/A Fine	Out	Heat Recovery	-	1	ON	Idling	-	-	-	-	1600	Error2	-	-	Low
	00	00	L/A In1	In	Wall Mounted	3000	1/A	ON	Cool	26	13.5	16	16	1600	Normal	-	-	Act
	02	02	L/A In2	In	Wall Mounted	3000	1/A	ON	Cool	26	13.5	16	16	1600	Normal	-	-	Act
	03	03	L/A In3	In	Wall Mounted	3000	1/A	ON	Cool	26	13.5	16	16	1600	Normal	-	-	Act
02	00			Out	Heat Pump	-	1A	ON	Idling	-	-	-	-	1600	Normal	-	-	Low
	00			In	Universal	3000	1/A	ON	Cool	26	13.5	16	16	1600	Normal	-	-	Act
03	00		L/A Cooling407	Out	Cooling Only	-	1A	ON	Idling	-	-	-	-	1600	Normal	-	-	St
	00		L/A In3	In	Wall Mounted	3000	1/A	ON	Cool	26	13.5	16	16	1600	Normal	-	-	Act
04	00		L/A Cooling22	Out	Cooling Only	-	1A	ON	Idling	-	-	-	-	0	Normal	-	-	Low
	00		L/A In4	In	Wall Mounted	3000	1/A	ON	Cool	26	13.5	16	16	1600	Normal	-	-	Hi
05	00		1B Heat Pump M14	Out	Heat Pump	-	-	ON	Idling	-	-	-	-	-	Normal	-	-	-
	00			Out		-	-	ON	Idling	-	-	-	-	-	Normal	-	-	-
	00			In	Universal	3000	1B	ON	Cool	26	13.5	16	16	1600	Normal	-	-	Hi

1) System List

Displays the overall operation status of all or specified units in the system in list form.

2) Equipment Detail (Diagram)

Displays detail information for sensor values, electrical components etc. for specified units in schematic. Information can be used to check operation status of units and make detail analysis.

3) Equipment Detail (List)

Displays the detail information for sensor values, electrical components etc. of units in a specified refrigerant system.

4) Operation History

Record of indoor units or outdoor unit operation. The displayed operation history can be printed or saved to a CSV file.

5) Error History

Displays the information for each unit. The information can sequentially be displayed up to 50 items.

6) Remote File Download

Operation history for specified system, units and times can be downloaded.

7) Commissioning Tool

During a test run, the outdoor unit/indoor unit sensor data can be saved for completing the commissioning report. When test concludes, this data can be exported in CSV file format.

8) Network Topology Analyzer

A list of units connected to the VRF system network is displayed in network segments in tree form.

9) Remote Setting

Setting of the indoor unit can be performed remotely.

10) System Time Setting

Time of day setting, for all controllers in a system, can be performed simultaneously.

11) Software Version

The software version of units is displayed.

12) Central Adjustment

Limitations on individual indoor units can be adjusted from the central controller (remote controller limit, temperature limit).

13) Model Name Writer

A custom model name can be given for an indoor unit.

14) Error Memory Reader

If an error occurs in an indoor unit, the system records the operation data before the error and saves to a CSV file.

Note: To perform "Error Memory Reading", the Service Tool must be connected directly to the corresponding outdoor unit. Refer to the Operation Manual of the Service Tool for detail.

15) Time Guard Information

Data for determining maintenance schedule (integrated time for compressor, fan, etc.) for the indoor and outdoor units can be output to a CSV file.

Web Monitoring Tool

UTY-AMGXZ1 Software

Can support up to
4
refrigerant circuits

Up to
1,600
indoor units supported

Product features

- Enables remote monitoring and troubleshooting
- Remote operation status notification via dedicated internet connection
- No special software needed to view data remotely, requires only general web browser.

Web Monitoring System

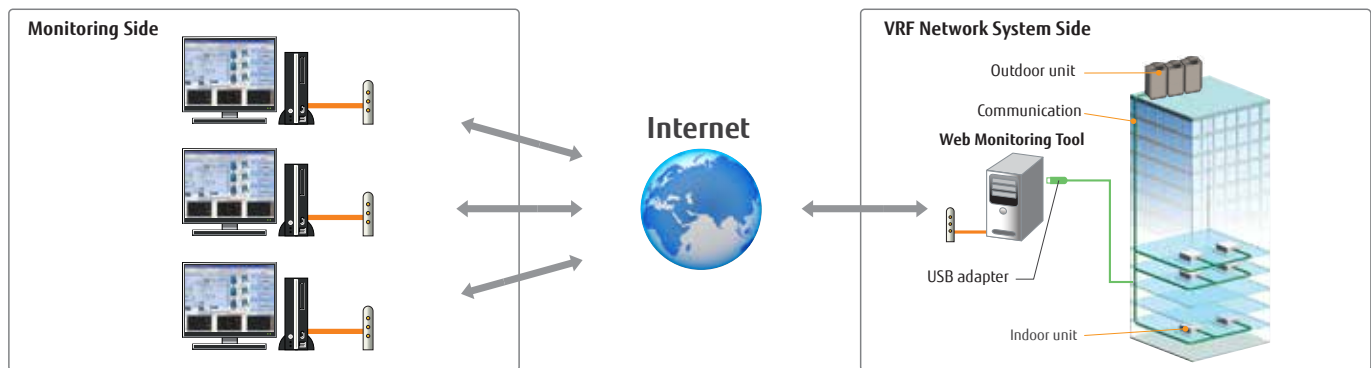

Support 4 VRF network systems

Monitoring of up to 1,600 indoor units via USB adapter.
Suitable for large-scale buildings or hotels.

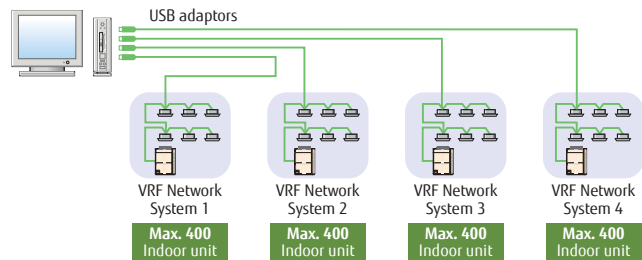

Personal computer system requirements:

Model name	UTY-AMGXZ1
Operating system	<ul style="list-style-type: none"> • Microsoft® Windows® 7 Professional (32-bit or 64-bit) SP1 • Microsoft® Windows® 8.1 Pro (32-bit or 64-bit) • Microsoft® Windows® 10 Pro (32-bit or 64-bit)
CPU	1 GHz or higher
Memory	<ul style="list-style-type: none"> • 1 GB or more (for Windows Vista®, Windows® 7 [32-bit], Windows® 8.1 [32-bit], and Windows® 10 [32-bit]) • 2 GB or more (for Windows® 7 [64-bit], Windows® 8.1 [64-bit], and Windows® 10 [64-bit])
HDD	40 GB or more of free space
Display	1366 x 768 or higher resolution
Interface	<ul style="list-style-type: none"> • USB port (for 10 USB Network Interface Max.4, Software protection key) • Either of the following interface is required for remote connection: <ul style="list-style-type: none"> - Internet using LAN: Ethernet port is required
Software	Internet Explorer® 11 or Microsoft Edge / Adobe® Reader® 9.0 or later

Packing list	Quantity	Application
WHITE-USB-KEY (Software protection key)	1	Software protection key to be connected to USB port on the Service Tool-installed PC. These products runs only on a PC with WibuKey.

- Personal computer that meet the following system requirements
- Echelon® U10 USB Network Interface – TP/FT-10 Channel (Model number: 75010R) (Required for each VRF Network.)

Design Simulator

Easy equipment selection, complete selection output, reliable project management

Fujitsu's Design Simulator makes it easy to design and select equipment for complex building HVAC systems. The software output contains all important design data including: Equipment Schedule, Piping and Wiring Layout, etc. (all of the information that typically is needed to estimate a VRF project) Design Simulator simplifies the design process. To design a system, just select the indoor unit types for each system, and the software will automatically select the outdoor unit and create the piping and wiring diagram. Design Simulator also checks all of the equipment information to ensure proper installation.



Step 1 Select the model

Choose the model for each system.

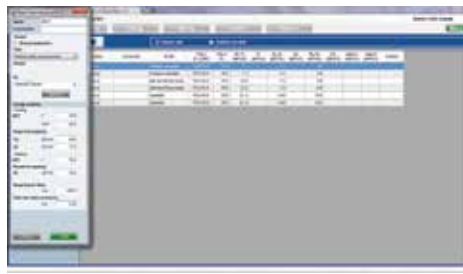

Step 2 Select the Indoor Unit

Choose the unit types and the conditions and the software will select the correct indoor unit. Indoor unit can also be selected manually.



Step 2b Select the Outdoor Air Unit

If desired, choose the "Outside Air Unit" option. Outside Air Units are selected based on required airflow.



Step 3 Select the Outdoor Unit

Using the Drag & Drop function, connect the indoor unit to the appropriate outdoor unit.

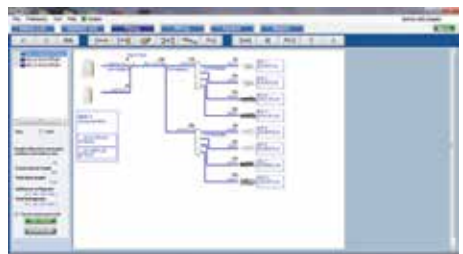

Step 4 Piping Length / Piping Diagram

Piping diagram is created automatically. As piping lengths are entered, system automatically calculates refrigerant charge.



Step 5 Wiring / Remote Control Diagram

Automatically creates the wiring diagram. Simple grouping functions create a custom wiring diagram for the project.



Step 6 Select BMS Gateways and Central Controllers

Choose additional devices to meet the needs of the project.



Step 7 Report Output

Design Simulator creates a project output with all of the project schedules and schematic drawings.

Setting

Design Simulator can be customized for any geographic location.

- Units (US conventional / Metric)
- Language Setting
- Custom Database Function
- Output Settings

Design Simulator (continued)

Name of software	Design Simulator	
Latest Version	Design Simulator	Ver 3.6.4.01 (PG)
	DB	Ver 2021.07.27(DB)
	Design Simulator Installation	Ver1.0.5.01 (PG)
	DB	Ver 2021.07.27(DB)
	Design Simulator Drawing	Ver 0.1.4.01 (PG)
DB	Ver 2021.07.27(DB)	
Personal Computer	Compatible machine that runs Microsoft® 8.1/10	
Copyright holder	FUJITSU GENERAL LIMITED	
System requirements	Hardware	CPU: Intel® Core™ i3 2GHz or higher
		Memory: 2GB or more (Windows® 8.1/10 32-bit) 4GB or more (Windows® 8.1/10 64-bit)
		HDD: 10GB or more of free space
	Display	1024 x 768 or higher resolution
	Software	Internet Explorer® 11.0
Adobe® Reader® 10.0 or later		
Microsoft® Word 2010/2013/2016/2019 PDF Output Microsoft® Word, Excel 2010/2013/2016/2019 Microsoft® .NET Framework 4.6.1 or Higher		

Output

Equipment selections and schedules can be output in standard industry file formats.

- Word format
- Excel format
- Auto CAD format
- 2D Data
- 3D Data (RevitMep data)
- Wiring and piping schematic drawings

Auto Update

Software updates automatically with the latest product data.

- Maintains software integrity
- Maintains software history
- Updates product information

Building Information Modeling (BIM)

Fujitsu provides the Building Information Modeling (BIM) object models and contents for our VRF system to the architect, designer and contractor using Autodesk® Revit® technology .

Required software:

Autodesk® Revit® series software:

- Autodesk® Revit® Architecture
- Autodesk® Revit® MEP
- Autodesk® Revit® Structure

Data format:

- RFA

Product parameter

- Power source
- Input power
- Capacity
- Airflow rate
- Sound pressure level
- Dimensions
- Weight
- Connection pipe diameter
- Refrigerant
- Material/Color

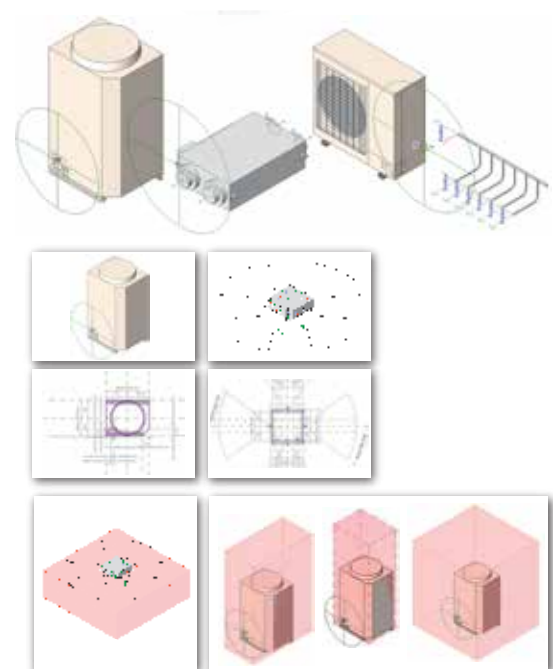

Cypetherm Fujitsu with EnergyPlus™

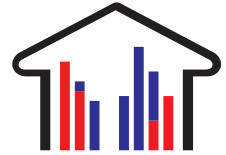

Intuitive AIRSTAGE Energy Modeling

This software allows you to model and simulate HVAC energy demand and consumption in the building with AIRSTAGE and compare with other commonly used HVAC equipment. Estimate potential energy savings and ROI values.

Easy Modeling

- Easy Wizard for Modeling
- 200 plus US cities included for weather data
- Default values selected based on building types

Simple Reports

- Simple Energy Demand/Consumption reports
- Comparison with existing/alternative HVAC system
- ROI, NCV number

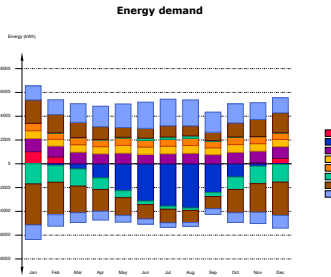
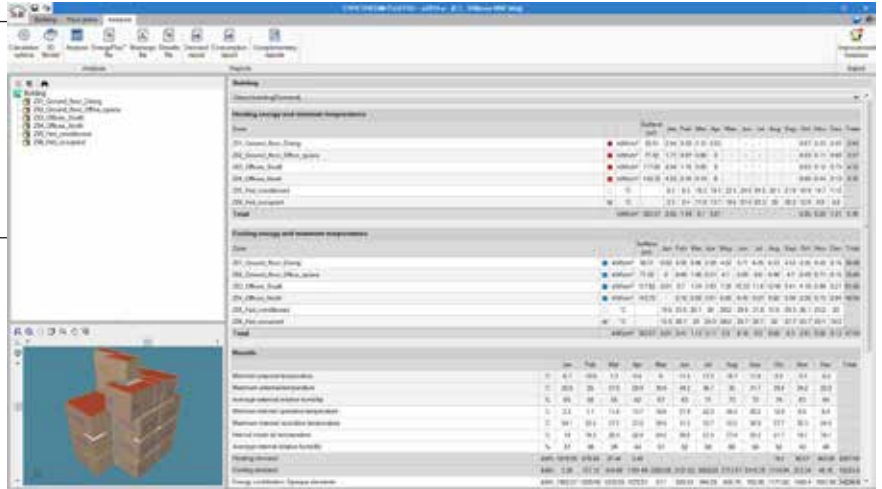

The following table displays the numerical values of the preceding bar chart, the energy balance of the whole building, as the sum of the energy involved in the energy balance of each thermal zone of the building calculation model.

The sign criteria adopted consists of using positive values for energy contributed to the zone and negative values for energy that is extracted.

Month	Jan	Feb	Mar	Apr	May	Jun	Jul	Aug	Sep	Oct	Nov	Dec	Year
Building	1066.1	1024.8	1171.0	1012.5	817.0	628.5	466.3	308.8	752.1	1171.0	1064.4	1468.1	10652.7
Q1	1484.2	1224.9	1216.1	1012.5	1484.2	1224.9	1216.1	1012.5	1484.2	1224.9	1216.1	1012.5	1484.2
Q2	1216.1	1012.5	817.0	628.5	466.3	308.8	752.1	1171.0	1064.4	1468.1	1468.1	1468.1	1468.1
Q3	1012.5	817.0	628.5	466.3	308.8	752.1	1171.0	1064.4	1468.1	1468.1	1468.1	1468.1	1468.1
Q4	817.0	628.5	466.3	308.8	752.1	1171.0	1064.4	1468.1	1468.1	1468.1	1468.1	1468.1	1468.1
Q5	628.5	466.3	308.8	752.1	1171.0	1064.4	1468.1	1468.1	1468.1	1468.1	1468.1	1468.1	1468.1
Q6	466.3	308.8	752.1	1171.0	1064.4	1468.1	1468.1	1468.1	1468.1	1468.1	1468.1	1468.1	1468.1
Q7	308.8	752.1	1171.0	1064.4	1468.1	1468.1	1468.1	1468.1	1468.1	1468.1	1468.1	1468.1	1468.1
Q8	752.1	1171.0	1064.4	1468.1	1468.1	1468.1	1468.1	1468.1	1468.1	1468.1	1468.1	1468.1	1468.1
Q9	1171.0	1064.4	1468.1	1468.1	1468.1	1468.1	1468.1	1468.1	1468.1	1468.1	1468.1	1468.1	1468.1
Q10	1064.4	1468.1	1468.1	1468.1	1468.1	1468.1	1468.1	1468.1	1468.1	1468.1	1468.1	1468.1	1468.1
Q11	1468.1	1468.1	1468.1	1468.1	1468.1	1468.1	1468.1	1468.1	1468.1	1468.1	1468.1	1468.1	1468.1
Q12	1468.1	1468.1	1468.1	1468.1	1468.1	1468.1	1468.1	1468.1	1468.1	1468.1	1468.1	1468.1	1468.1
Q13	1468.1	1468.1	1468.1	1468.1	1468.1	1468.1	1468.1	1468.1	1468.1	1468.1	1468.1	1468.1	1468.1
Q14	1468.1	1468.1	1468.1	1468.1	1468.1	1468.1	1468.1	1468.1	1468.1	1468.1	1468.1	1468.1	1468.1

Improvement measures analysis

Period	Future savings		Annual maintenance cost		NCV Total savings (\$)
	Partial	Accumulated	Partial	Accumulated	
0	1636.50	0.00	0.00	0.00	-15000.00
1	1613.01	1636.50	0.00	0.00	-13363.50
2	1589.85	3249.51	0.00	0.00	-11750.49
3	1567.03	4839.36	0.00	0.00	-10160.64
4	1544.54	6406.39	0.00	0.00	-8593.61
5	1522.37	7950.93	0.00	0.00	-7049.07
6	1500.52	9473.30	0.00	0.00	-5526.70
7	1478.98	10973.82	0.00	0.00	-4026.18
8	1457.75	12452.80	0.00	0.00	-2547.20
9	1436.82	13910.55	0.00	0.00	-1089.45
10	1416.20	15347.37	0.00	0.00	347.37
11	1395.87	16763.57	0.00	0.00	1762.57
12	1375.84	18159.45	0.00	0.00	3159.45
13	1356.09	19535.28	0.00	0.00	4555.28
14	1336.62	20891.37	0.00	0.00	5951.37

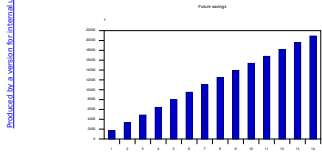

Improvement measures analysis

1.- RESULTS SUMMARY

Improvement measures	Investment cost (\$)	Annual energy invoice reduction (\$)	Payback (year)	NCV (year)		Energy classification (Btu-year)	
				Before	After	Before	After
Improvement measure 1. VRF	15000.00	1636.50	9.17	9.76	124076.30	76556.30	

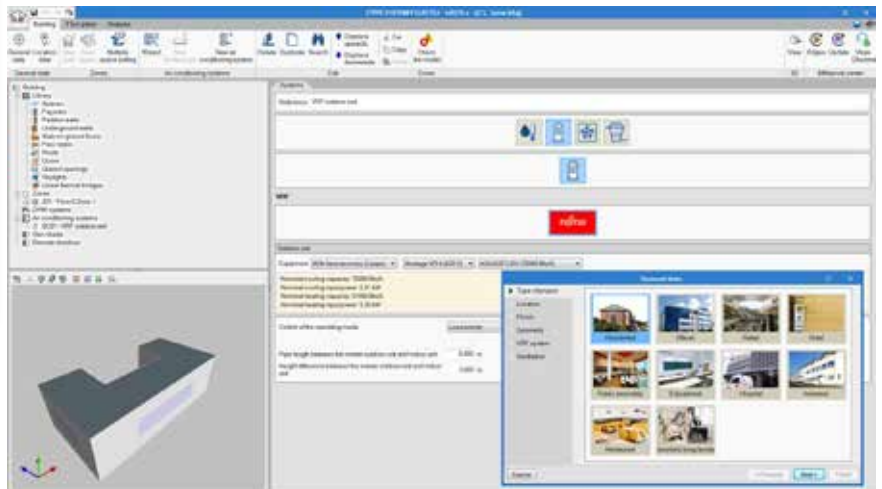
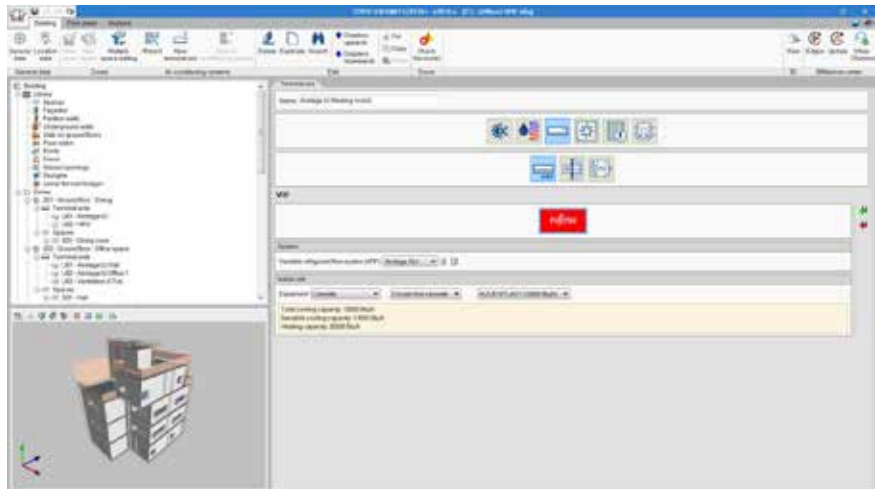



Optional Accessories Overview

Optional Accessories For Cassette



UTY-SHZXC

Human Sensor Kit

Room temperature can be controlled by detecting the temperature accurately from the built-in sensor

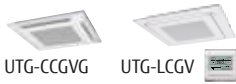

UTG-CCGVG
For Compact Cassette

UTG-LCGV

Cassette Grille

Flexibility to match various interiors with extensive cassette grille lineup.



UTG-CCGV
For Cassette

UTG-LCGVCW

UTG-LCGVCB

For Circular Flow Cassette



For Compact Cassette

For Cassette

Outside Air Intake Kit

Outside air can be brought in via the indoor unit by external fan connected to the kit.

UTZ-KXGA for Cassette AUUB30,36
UTZ-KXGB for Cassette AUUB18,24
UTZ-KXGC for Compact Cassette AUUA7 thur AUUA24

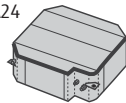

Insulation for High Humidity

Optional Insulation kit can be used to avoid condensation in high humidity installation locations.

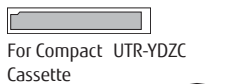

For Compact Cassette

UTR-YDZB For Cassette

Air Outlet Shutter Plate

If required, a shutter plate can be field installed to make the cassette into a 3-way cassette.

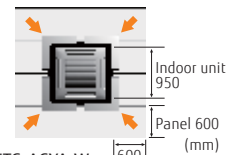

UTG-AGYA-W

Wide Panel

Optional Wide Panel can be used to fill space around cassette.

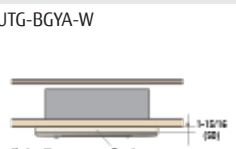

UTG-BGYA-W

Panel Spacer

If required, Panel Spacer can be used to fill vertical space between ceiling and the cassette.

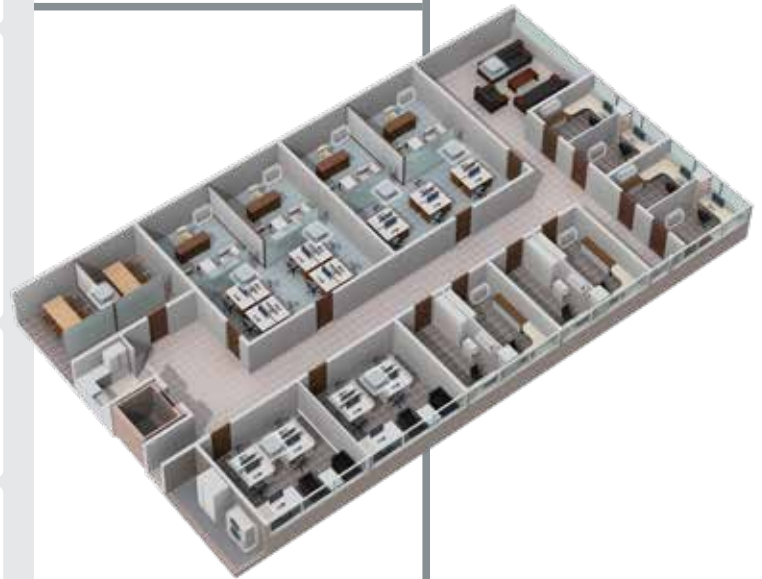

Optional Accessories For Floor

For Floor

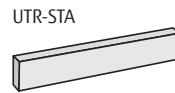

UTR-STA

Half Concealed Kit

Kit can be used to partly cover floor type indoor units when mounted by a wall.

Optional Controls For Ducted Indoor Units

For Ducted Indoor Units p. 116



Airzone

Communicating zoning system featuring proportional, modulating dampers and smart controllers.

Optional Controls For Indoor Units

For Indoor Units p. 118

UTY-SPWX



Highrise 360 Kit

Kit increases the max height difference between outdoor and indoor unit.



Optional Accessories

For Duct & Ceiling



UTD-GXSA-W / UTD-GXTA-W
UTD-GXTB-W

Auto Louver Grille Kit

Elegant Grille kit for comfortable air distribution.

p. 114



UTY-XSZXZ1

Remote Sensor Unit

Remote sensor for localized temperature sensing and increased comfort.



UTD-LF25NA
UTD-LF60KA

Long Life Filter

Efficient Long Life air filter for reduced service requirements.

UTD-SF045T



UTD-RF204

Flange

Adapter Flange for connection of air ducts.

UTZ-PX1NBA
UTR-DPB24T



Condensate Drain Pump

Connection Parts

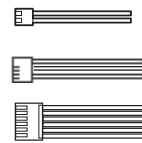

External Connect Kit & Set

Wire Connection kit for connection of external devices to Indoor unit.



Pipe Connection Units

For branch connections in VRF systems with multiple indoor units.



External Power Supply Unit

Can protect the units in the system even if some powers of indoor units are shut down in the system.

Optional Accessories

For Outdoor Unit

p. 115



Wind Baffles

Prevent fan stoppage against high wind



Snow Hood

Prevent snow accumulation inside outdoor unit



Hail Guard

Protection of outdoor unit coil from hail

REQUIRED for all AIRSTAGE system installations

VRF Communication Cable

LonWorks® Cable

K00250LW (250 ft)
K00500LW (500 ft)



Piping Accessories

Separation Tubes

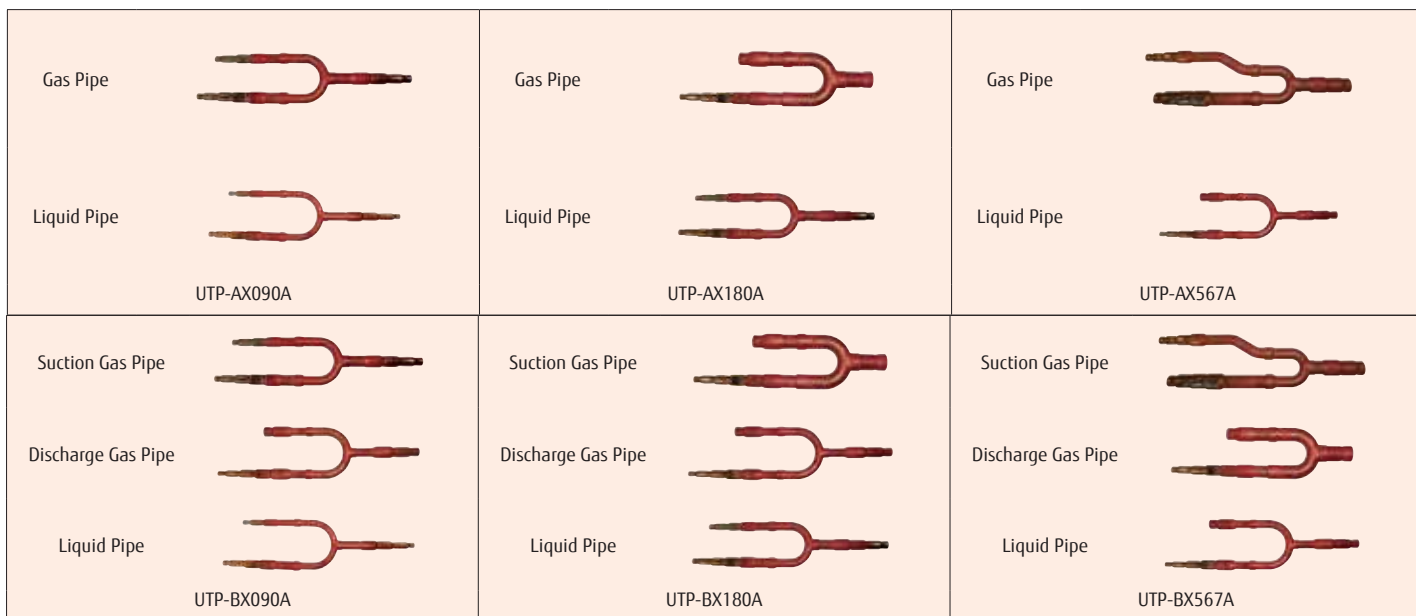

Specifications

Separation Tube

Model name	UTP-AX090A	UTP-AX180A	UTP-AX567A
Total cooling capacity of indoor unit (X) (kBTU/h)	$X < 96.5$	$96.5 \leq X < 193$	$193 \leq X$

Model name	UTP-BX090A	UTP-BX180A	UTP-BX567A
Total cooling capacity of indoor unit (X) (kBTU/h)	$X < 96.5$	$96.5 \leq X < 193$	$193 \leq X$

Outdoor Unit Branch Kit

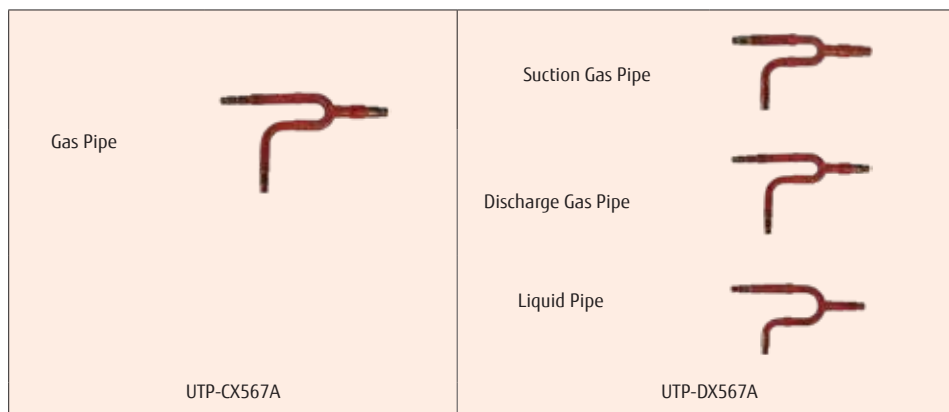









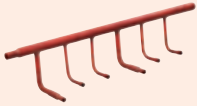

Specifications

Outdoor Unit Branch kit

Model name	UTP-CX567A (for VU-V)	UTP-DX567A (for VU-V)
Number of Outdoor unit	2 outdoor units	1
	3 outdoor units	2





Header

	6 Branch	8 Branch
Gas Pipe		
Liquid Pipe		
	UTR-H0906L / UTR-H1806L	UTR-H0908L / UTR-H1808L
Suction Gas Pipe		
Discharge Gas Pipe		
Liquid Pipe		
	UTP-J0906A / UTP-J1806A	UTP-J0908A / UTP-J1808A

Specifications Header

Model name	3-6 Branches	UTR-H0906L	UTR-H1806L
	3-8 Branches	UTR-H0908L	UTR-H1808L
Total cooling capacity of indoor unit (X) (kBTU/h)		X < 96.5	96.5 ≤ X < 193
Model name	3-6 Branches	UTP-J0906A	UTP-J1806A
	3-8 Branches	UTP-J0908A	UTP-J1808A
Total cooling capacity of indoor unit (X) (kBTU/h)		X < 96.5	96.5 ≤ X < 193

RB Unit

<p>Single type</p> <p>UTP-RU01DH Single Type RBU - 27,000 BTU or less</p> <p>UTP-RU01EH Single Type RBU - 60,000 BTU or less</p> <p>UTP-RU01FH Single Type RBU - 96,000 BTU or less</p> 	<p>Multi type</p> <p>UTP-RU04EH Multi Type RBU - 191,000 BTU or less (60,000 BTU or less per branch)</p> 	<p>UTP-RU08DH 8 Branch RBU Unit - 245,000 BTU or less (27,000 BTU or less per branch)</p> 	<p>UTP-RU12DH 12 Branch RBU Unit - 324,000 BTU or less (27,000 BTU or less per branch)</p> 
---	--	--	--

Specifications RB Unit

Type	Single type			Multi type			
Model name	UTP-RU01DH	UTP-RU01EH	UTP-RU01FH	UTP-RU04EH	UTP-RU08DH	UTP-RU12DH	
Power source	Single phase 230V, 50Hz			Single phase 230V, 50Hz	Single phase 230V, 60Hz		
Input power	W	28	28	41	110	226	339
Number of branches	1	1	1	4	8	12	
Maximum capacity of connectable indoor units (Q)	kBTU/h	Q ≤ 28	Q ≤ 60	Q ≤ 96	Q ≤ 191*1	Q ≤ 245,000	Q ≤ 324,000
Maximum capacity of connectable indoor units per branch (Q)	kBTU/h	Q ≤ 27	Q ≤ 60	Q ≤ 96	Q ≤ 96	Q ≤ 27,000	Q ≤ 27,000
Max number of connectable indoor units per branch		3	8	8	8	6	6
Dimensions (H×W×D)	in. (mm)	7-13/16 × 11-3/4 × 10-9/16 (198 × 298 × 268)			10-1/4 × 25-7/8 × 16-7/8 (260 × 658 × 428)	11-3/4 × 26 × 24-5/16 (298 × 660 × 618)	11-3/4 × 39 × 24-5/16 (298 × 990 × 618)

*1: In case of two RB units connected in series (total 8-branches), maximum capacity of connectable indoor units is up to 191kBTU/h

Auto Louver Grille Kit (Option)

Models

UTD-GXSA-W / UTD-GXTA-W

UTD-GXSB-W

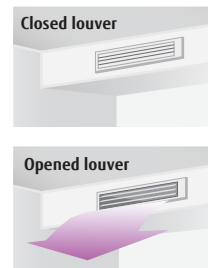

Available for Mini and Slim Ducted Indoor Units
(page 52)

Flexible Control

- Convenient control of Auto Louver kit from remote controller of indoor unit.
- Can be used for vertical auto swing or fixed louvers. 4 convenient louver angle settings.
- Louvers close automatically when indoor unit is not in operation.

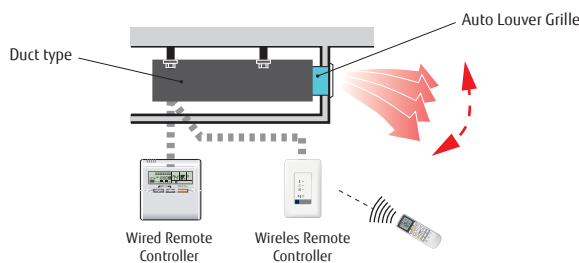

Dimensions

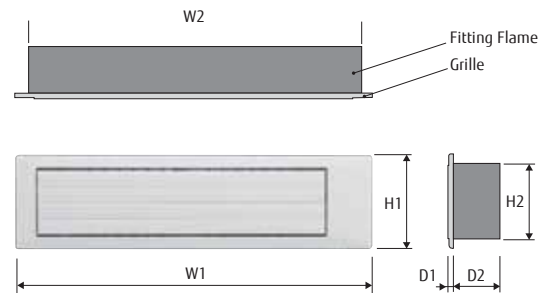

Model Name	W1	W2	H1	H2	D1	D2	Unit: In.
UTD-GXSA-W / UTD-GXTA-W	26-7/8	25-3/8	7-1/16	5-13/16	3/8	3-5/16	
UTD-GXSB-W	34-3/4	33-1/4					

Specifications

Model name			UTD-GXSA-W / UTD-GXTA-W	UTD-GXSB-W
Applicable Indoor Unit			UTD-GXSA-W: ARUL7/9/12/14TLAV2 UTD-GXTA-W: ARUL4TLAV2	ARUL18TLAV
Power Supply			Connecting with Control box of indoor unit	
Fixing of Auto Louver Grille			Screw fixing to Flange or Square Duct	
Extension Square Duct Limit			39-3/8" (Max. duct length between indoor unit and grille)	
Net Dimension (H x W x D)		inch (mm)	7-1/16x26-7/8x(3-5/16+3/8) [180x683x(84+9)]	7-1/16x34-3/4x(3-5/16+3/8) [180x883x(84+9)]
Weight	Net	lb.	4.4 (2.0)	5.6 (2.5)
	Gross	(kg)	6.7 (3.0)	7.8 (3.5)
Color			White	
Louver Motor			Stepping Motor	
Accessories			Fitting Flange, etc.	
Operation range	Cooling	°F (°C)	64 to 90 (18 to 32)	
	Heating	% RH	80% or less	
			50 to 86 (10 to 30)	

Wind Baffles, Snow Hoods, Hail Guards

Protect Your Investment

Wind Baffles ensure continued operation during high wind conditions, especially with roof-mounted units. Wind Baffles prevent nuisance stoppage of outdoor unit.

Features

- Solid & sturdy design for durability and reduced vibrations
- Same color as outdoor air unit for better aesthetics
- Easy installation



Actual product color may be different from the colors shown here. Specifications and design are subject to change without notice.



Model	Wind Baffle	Model	Wind Baffle	Model	Wind Baffle
AOU36RLAVS	UTZ-DUWBUA	AOU36RLAVM	UTZ-DUWBTA	AOU72RLAVL	UTZ-DUWBRA (Models include 2 UTZ-DUWBUA units)
AOU48RLAVS		AOU48RLAVM		AOU96RLAVL	
AOU36RLAVS4		AOU60RLAVM		AOU120RLAVL	
AOU48RLAVS4		AOU36RLAVM4			
	AOU48RLAVM4				
	AOU60RLAVM4				

NOTE: Wind baffles do not extend low ambient cooling capacities. Please refer to Application Bulletin AH20201101A for best practices regarding wind baffle usage.



Snow Hoods protect your outdoor equipment from poor performance due to accumulation of snow.



Model	Group	Snow Hood					
		UTZ-DUSHUA	UTZ-DUSHTA	UTZ-DUSHRA	UTZ-DUSHVTA	UTZ-DUSHVUA	UTZ-DUSH1VLA/UTZ-DUSH2VLA/UTZ-DUSH3VLA
AOU36RLAVS4	U	1					
AOU48RLAVS4		1					
AOU36RLAVM4	T		1				
AOU48RLAVM4			1				
AOU60RLAVM4			1				
AOU72RLAVL	R			1			
AOU96RLAVL				1			
AOU120RLAVL				1			
AOUA72-96ULBV5/ULCV5	VT				1		
AOUA120ULBV5/ULCV5	VU					1	
AOUA144-192ULBV5/ULCV5	VL						1 / 1 / 2 (includes 1 top, 1 rear, 2 side)

Hail Guards protect your outdoor unit coil from hail damage.



Model	Group	Hail Guard					
		UTZ-DUHGUA	UTZ-DUHGTA	UTZ-DUHGRA	UTZ-DUHGVTA	UTZ-DUHGVUA	UTZ-DUHGVLA
AOU36RLAVS4	U	1					
AOU48RLAVS4		1					
AOU36RLAVM4	T		1				
AOU48RLAVM4			1				
AOU60RLAVM4			1				
AOU72RLAVL	R			1			
AOU96RLAVL				1			
AOU120RLAVL				1			
AOUA72-96ULBV5/ULCV5	VT				1		
AOUA120ULBV5/ULCV5	VU					1	
AOUA144-192ULBV5/ULCV5	VL						1

Airzone

Compatible with most AIRSTAGE 2-wire and 3-wire single zone systems.

Airzone is an intelligent, communicating zoning system for AIRSTAGE ducted indoor units featuring proportional modulating dampers and smart controllers. Additional ductless and ducted single zone systems may be integrated for total HVAC control.

How does it work?

All Airzone dampers and optional Zone Modules are connected by a 4-wire cable for power and communication. Dampers are positioned to provide optimum airflow into a zone based on demand monitored through zone controllers. The indoor unit fan is adjusted to meet the instantaneous total demand of all calling zones.



Commercial Application- Wide range of damper sizes both wired and wireless allows implementing into lite commercial projects easier.



Airzone VAF Wired Blueface Controller White



Airzone VAF Control Board with Fujitsu UART Communication Region 2



Airzone Webserver Hub



Airzone VAF 8" Wired Intelligent Round Damper



Airzone VAF 8" Wireless Intelligent Round Damper

Benefits

- An Airzone system can provide optimum airflow into each zone, thus reducing excess equipment capacity.
- Provides ideal temperature control of each zone in your home or office.
- Built in communication gateways maximize Fujitsu Heat Pump inverter efficiency.
- Integrate single zone systems with the ducted, modulating damper system.
- Modulating dampers and proportional fan control eliminates the need for a bypass duct!
- Flexible selection of individual damper sizes and controllers to fit a wide range of applications.
- With the Webserver Hub, you can control your Airzone VAF system and the serving AIRSTAGE unit through the Airzone Cloud, and integrate your system to a BMS using BACnet.

Features

- Control and monitor up to 10 individual zones.
- Adjustable minimum and maximum damper positions.
- Control of optional auxiliary heat of the ducted, zoned unit.
- Principal controller provides simple, single point temperature management of ALL zones!
- Selection of wired and wireless controllers.
- Wired and wireless dampers available. Size ranges from 6" to 14" in diameter.
- Flexible control of up to 10 hydronic zones is possible, as either primary or auxiliary heat.
- Dry Contact Inputs for occupancy sensor and window switch to open/close individual damper.

Connection Diagram

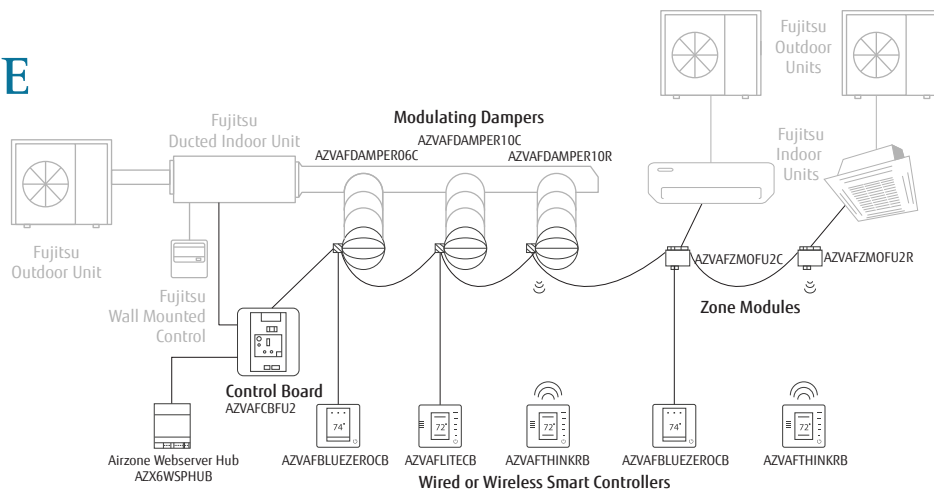

Airzone, cont'd.



PRODUCT OFFERING		
FAMILY	REFERENCE VAF	DESCRIPTION
Control board	AZVAFCB2FU2	AIRZONE VAF CONTROL BOARD WITH FUJITSU UART COMMUNICATION REGION 2
	AZVAFCB2FUJ	AIRZONE VAF CONTROL BOARD WITH FUJITSU 3 WIRES COMMUNICATION REGION 2
Controllers	AZVAFBLUEZEROCB	AIRZONE VAF WIRED BLUEFACE PRINCIPAL CONTROLLER WHITE
	AZVAFTHINKRB	AIRZONE VAF WIRELESS THINK CONTROLLER WHITE
	AZVAFLITECB	AIRZONE VAF WIRED LITE CONTROLLER WHITE
	AZVAFLITERB	AIRZONE VAF WIRELESS LITE CONTROLLER WHITE
Zone modules	AZVAFZMOFU2C	AIRZONE VAF WIRED ZONE MODULE WITH FUJITSU UART COMMUNICATION
	AZVAFZMOFUJ2C	AIRZONE VAF WIRED ZONE MODULE WITH FUJITSU 3 WIRES COMMUNICATION
	AZVAFZMOFU2R	AIRZONE VAF WIRELESS ZONE MODULE WITH FUJITSU UART COMMUNICATION
	AZVAFZMOFUJR	AIRZONE VAF WIRELESS ZONE MODULE WITH FUJITSU 3 WIRES COMMUNICATION
	AZVAFDAMPER06C	AIRZONE VAF 6" WIRED INTELLIGENT ROUND DAMPER
	AZVAFDAMPER08C	AIRZONE VAF 8" WIRED INTELLIGENT ROUND DAMPER
	AZVAFDAMPER10C	AIRZONE VAF 10" WIRED INTELLIGENT ROUND DAMPER
	AZVAFDAMPER12C	AIRZONE VAF 12" WIRED INTELLIGENT ROUND DAMPER
	AZVAFDAMPER14C	AIRZONE VAF 14" WIRED INTELLIGENT ROUND DAMPER
	AZVAFDAMPER06R	AIRZONE VAF 6" WIRELESS INTELLIGENT ROUND DAMPER
	AZVAFDAMPER08R	AIRZONE VAF 8" WIRELESS INTELLIGENT ROUND DAMPER
	AZVAFDAMPER10R	AIRZONE VAF 10" WIRELESS INTELLIGENT ROUND DAMPER
	AZVAFDAMPER12R	AIRZONE VAF 12" WIRELESS INTELLIGENT ROUND DAMPER
	AZVAFDAMPER14R	AIRZONE VAF 14" WIRELESS INTELLIGENT ROUND DAMPER
	AZVAFZMRADC	AIRZONE VAF WIRED ZONE MODULE ONLY RADIANT
	AZVAFZMRADR	AIRZONE VAF WIRELESS ZONE MODULE ONLY RADIANT
Zone-supplemental heating	AZVAF5OUTPUTS	AIRZONE VAF RELAY RADIANT HEAT CONTROL MODULE
Accessories	AZVAF10KPROBE	AIRZONE VAF 10 KOHM NTC THERMISTOR
	AZVAFPOWER	AIRZONE VAF ADDITIONAL 12V POWER SUPPLY
	AZX6WSPHUB	AIRZONE WEBSERVER HUB
Spare parts	AZVAFDAMPERZMC	AIRZONE VAF SPARE DAMPER WIRED ZONE MODULE
	AZVAFDAMPERZMR	AIRZONE VAF SPARE DAMPER WIRELESS ZONE MODULE
	AZVAFDAMPERACT	AIRZONE VAF SPARE DAMPER ACTUATOR

Highrise 360 Kit (for VU-V Series*)

UTY-SPWX

Design flexibility

The Highrise 360 kit increases the 164ft max height difference between outdoor unit and indoor unit to 360ft, when outdoor unit is located above the indoor units.

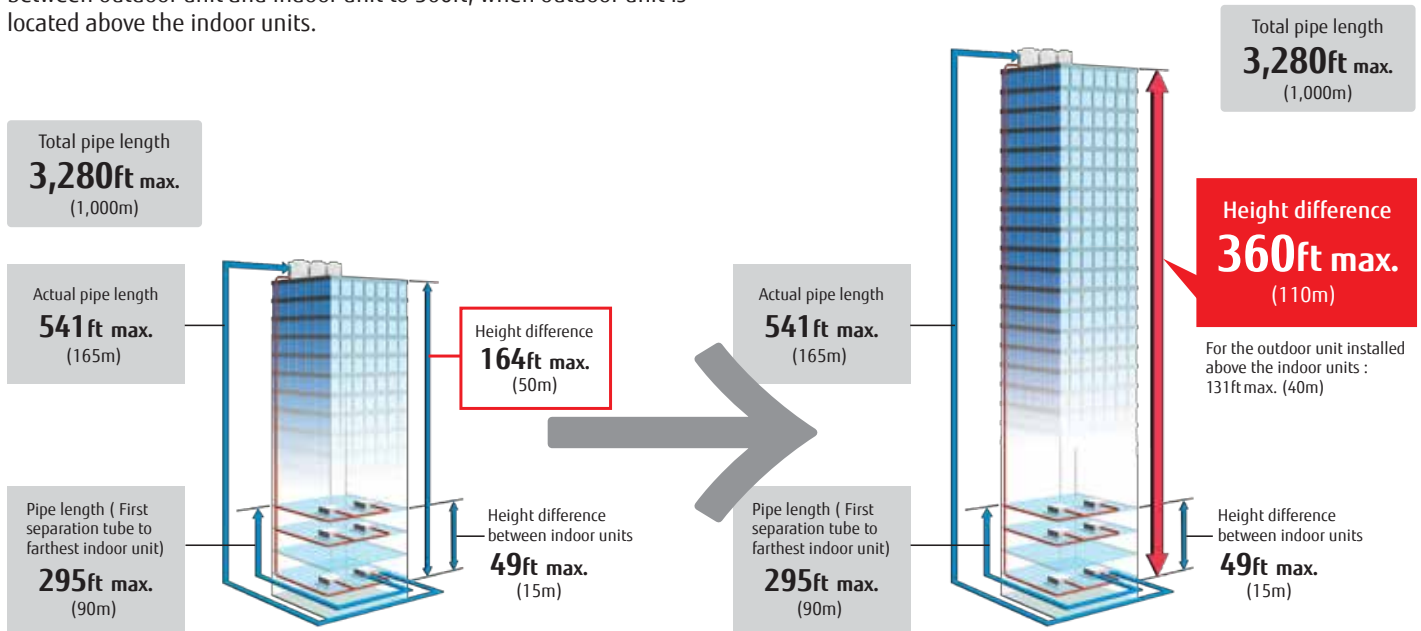

System Overview

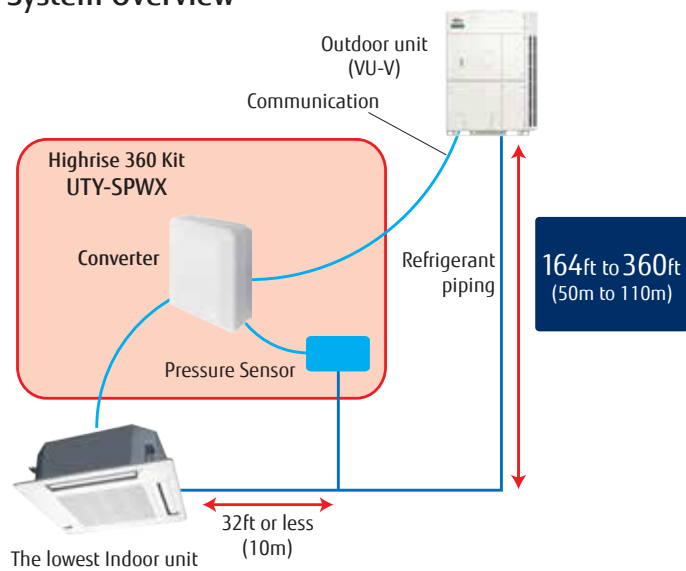

Highrise 360 Kit Components

Pressure sensor kit (Converter)	
Refrigerant pressure sensor	
Joint pipe	

* NOTE: Heat pump options only

Applications

There are many applications for AIRSTAGE VRF systems including such markets as education, healthcare, hospitality, utilities, office buildings, apartment buildings, condominiums, and restaurants.

Note: VRF Heat Recovery system provides simultaneous Heating and Cooling.

Medical and Healthcare Facilities

VRF gives each patient individual control of their room temperature. Central control ensures that air conditioning is only delivered to rooms that are occupied.

Individual Control

VRF systems give each patient or each room individual control of their room temperature.

Maintenance

Since each refrigerant circuit has the ability to operate independently, a properly designed VRF system can add a layer of security to a HVAC system. If an individual unit needs to be serviced, the rest of the system can operate normally.



Central Control

Powerful central control ensures that heating and cooling are delivered to rooms that are occupied. This provides enormous savings for facilities with changing occupancy.

Clean Air

VRF systems can use ductless indoor units reducing the time and expense of maintain a ducted HVAC system and minimizing the risk of spreading duct-borne molds and bacteria.

Healthier Facility

VRF systems can be integrated with outside air systems to ensure that air quality meets the needs of the occupants. VRF provides the most comfortable environment for all occupants.

Optional

Building Management System (BMS) using BACnet, LonWorks or Modbus.



See AIRSTAGE VRF case studies on our site at www.fujitsugeneral.com/us/commercial/benefits/app-and-solutions.html

or on our **YouTube** channel FujitsuGeneral_USA

Vertical Farming or Grow Houses - Controlled Environmental Agriculture (CEA)

Recently VRF has been applied to CEA to effectively control the indoor environment for vertical farming.

Fujitsu AIRSTAGE VRF Systems eliminate short cycling and ensure consistent temperature control for optimal grow operations.



Central Control

VRF Central Controls keep HVAC Technicians out of the Production Rooms, enhancing biosecurity.

With Internet access, systems can be monitored and controlled remotely. System performance is assessed in real time, offering retro-commissioning opportunities that keep them operating at peak performance.



Healthier Facility

Indoor Unit Fan Coils can be located in Production Rooms, avoiding contamination risk associated with packaged equipment located outdoors.



Efficient

Variable speed inverter-driven compressors adjust performance to match the different stages of plant growth, eliminating short cycling that leads to premature equipment failure and undesirable spikes in temperature and humidity.



Flexible

Systems are modular, allowing for a wide range of capacities.

See AIRSTAGE VRF case studies on our site at www.fujitsugeneral.com/us/commercial/benefits/app-and-solutions.html

or on our **YouTube** channel [FujitsuGeneral_USA](https://www.youtube.com/channel/UCFujitsuGeneral_USA)

Educational and Religious Facilities

In a school, an investment in VRF is an investment in your community. VRF is more efficient than conventional systems, providing financial savings to the school for many years. Also, a quiet VRF system creates a much better learning environment for students.

Healthier Facility

VRF systems can be integrated with outside air systems to ensure that air quality meets the needs of the teachers and students.

Central Control

Powerful central control can monitor and control individual schools, or an entire college campus, from a single location.



Zoning

Save energy by heating and cooling only the classrooms that are occupied. Set temperature can be pre-programmed to meet the energy budget for the school district.

Comfort

VRF helps achieve a healthier, quieter, more comfortable and productive learning environment.

Optional

Building Management System (BMS) using BACnet, LonWorks or Modbus. Subtenant billing and Energy Charge apportionment.

See AIRSTAGE VRF case studies on our site at www.fujitsugeneral.com/us/commercial/benefits/app-and-solutions.html

or on our **YouTube** channel [FujitsuGeneral_USA](https://www.youtube.com/channel/UCFujitsuGeneral_USA)

Office Buildings and Retail Spaces

VRF provides a comfortable work environment for all employees. Zoning ensures that energy is only used to cool/heat occupied offices. Quiet indoor units and precise temperature control creates the most comfortable and productive work environment.

Flexible

As tenants and office configurations change, VRF system configurations can also be modified to meet the needs of new tenants.

Zoning

Save energy by only heating and cooling occupied offices. No more hot/cold calls since each zone or tenant has individual control of the set temperature.



Ease Of Installation

Can be installed in occupied office spaces with minimal disruption to occupants. Can even be installed without disrupting the existing HVAC system.

Quiet

Indoor units and outdoor units are quiet which creates a pleasant and productive work environment.

Control

Powerful controls options can manage and monitor entire building from a single location.

Comfort

VRF provides a comfortable work environment for all employees. Quiet indoor units and precise temperature control creates the most comfortable and productive work environment.

Optional

Building Management System (BMS) using BACnet, LonWorks or Modbus. Subtenant billing and Energy Charge apportionment.

See AIRSTAGE VRF case studies on our site at www.fujitsugeneral.com/us/commercial/benefits/app-and-solutions.html

or on our **YouTube** channel FujitsuGeneral_USA

Multi-Tenant Dwellings

VRF improves the quality of multi-tenant buildings. High quality VRF systems enables owners to save on energy and maintenance costs. With VRF, each tenant has individual control over the temperature setting for the comfort of their home.

Quality

By delivering quiet, efficient, and individual heating and cooling VRF improves the quality and the environment of multitenant buildings.

Energy Savings

Efficient VRF systems reduce the total energy costs for buildings over most other options. High quality systems reduce maintenance and service costs.



Individual Billing

Using the Energy Charge Allocation feature, landlords can easily bill each tenant for the share of total energy the individual tenant consumes.

Individual Comfort

With VRF, each tenant can have their own controller to set their room temperature for their maximum comfort.

Convenient Central Control

Landlord can monitor and control all indoor units from a central location. Landlord can even troubleshoot remotely.

Quiet

Indoor units ensures a quiet, comfortable living environment for all tenants.

Optional

Subtenant billing and Energy Charge apportionment.



See AIRSTAGE VRF case studies on our site at www.fujitsugeneral.com/us/commercial/benefits/app-and-solutions.html or on our **YouTube** channel FujitsuGeneral_USA

Fujitsu Commercial Financing

For any commercial HVAC installation, you can turn to Fujitsu with confidence for equipment that's not only readily available, but also thoughtfully engineered to install with ease and save energy on utility bills.

The Fujitsu Commercial Financing program is just as efficient and smart:



Quick, efficient approval process

- No cost, recourse or credit check for contractors
- End user credit approvals in 2 – 6 hours
- Contractor paid within 24 – 48 hours of install
- Single point of contact, from beginning to end

Solutions available for most projects

- Commercial units eligible, as well as controls and installation
- Churches, nonprofits and non-building owners qualify

Take advantage of convenient quote options:

-  FujitsuGeneralFinancing.com
-  1-800-606-0049

For More Information:

Marlin Capital Solutions
800-606-0049



For residential installations, please inquire with your Distributor or Fujitsu Sales Engineer about consumer financing options.



Things to know before you buy a FUJITSU system

Complete System Warranty

Standard warranties vary depending on model:



Fujitsu AIRSTAGE V-Series and AIRSTAGE J-Series (J-III) systems come standard with a 2-Year Compressor / 1-Year Parts warranty.



Fujitsu AIRSTAGE J-IV and J-IVS Series systems come standard with a 7-Year Compressor / 5-Year Parts warranty.

Extended warranties include:



10-Year Parts / Compressor warranty for qualified Fujitsu AIRSTAGE V and J-Series.



12-Year Parts / Compressor warranty for qualified AIRSTAGE J-Series Systems installed in a residential location by an Elite Contractor.

For full details, see AIRSTAGE Warranty Statements.

Trademarks

The Fujitsu logo is a registered trademark of Fujitsu Limited. The AIRSTAGE logo and name is a trademark of Fujitsu General America, Inc. ENERGY STAR® is a registered trademark of the EPA and DOE. Copyright © 2023 Fujitsu General America, Inc.

Non-Internet Retail Policy

Internet sales are strictly prohibited and unauthorized. Any HVAC systems purchased on the Internet, from an online retailer or any similar e-tailing website, OR where the original factory serial numbers of the display have been removed, defaced, or replaced in any way WILL NOT BE COVERED BY WARRANTY.

Note: Condensing units come pre-charged from factory. Additional refrigerant may be required, be sure to check installation manual for more details.

Things To Know Before You Install a FUJITSU System

Warning

Always use a licensed installer or contractor to install this product. Do not try to install the product yourself. Improper installation can result in water or refrigerant leakage, electrical shock, fire or explosion. Use only parts and accessories supplied or specified by Fujitsu. Ask a licensed contractor to install parts and accessories. Use of unauthorized or improper installation of parts and accessories can result in injury or property damage. Read the installation manual carefully before using this product. The installation manual provides important safety instructions and warnings which should be followed closely. For any questions or concerns, please contact Fujitsu General America, Inc. Proper sizing and installation of equipment is critical to achieve optimal performance.

Heat Pump Disclaimer

In most climates a heat pump will handle all of your heating needs. However, this system sometimes requires some other additional source of heat to satisfy heating requirements in the coldest environments. All of Fujitsu's heat pumps use inverter

technology and as such offer a wider operating range and more heat capacity than a standard heat pump but will not provide adequate heating if improperly sized or operated outside of its operating range. Specifications vary by model; please consult your contractor before choosing a heat pump as your only source of heat. Systems will maintain temperature up to +/-4 degrees relative to set temperature. To increase energy efficiency on multi-type systems, you should turn off the evaporators when heating or cooling is not needed.

Disclaimer

Fujitsu's products are subject to continuous improvements. Fujitsu reserves the right to modify product design, specifications and information in this brochure without notice and without incurring any obligations.

Certifications

ISO

ISO14001 is the standard defined by the International Organization for Standardization (ISO) related to environmental management systems. Fujitsu General America, Inc. has been acknowledged by an internationally accredited compliance organization as having an appropriate program of environmental protection procedures and activities to meet the requirements of ISO14001. The air conditioners manufactured by Fujitsu have received ISO9001 series certification for quality assurance.



- ISO9001
- ISO14001

ASTM

Our outdoor units shall withstand 1,000 hours of salt spray tested per procedure ASTM B117.

RoHS Compliant

Fujitsu participates in the RoHS Directive, which is the Restriction of Hazardous Substances in electrical and electronic equipment. It is an EU directive intended to protect the environment by forcing manufacturers to eliminate or severely curtail the use of cadmium, hexavalent chromium, and lead in all products from automobiles to consumer electronics.



AHRI Energy Guide® Program (U.S.)

To view AHRI numbers or Energy Guide labels, please go to www.ahridirectory.org.



HRAI EnerGuide® Program (Canada)

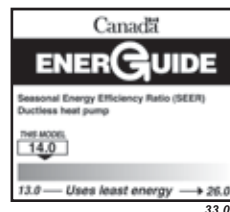

- Specifications and design are subject to change without notice for future improvement. For further details, please check with an authorized distributor.
- "AIRSTAGE" is a worldwide trademark of FUJITSU GENERAL LIMITED and is a registered trademark in Japan and other countries or areas.
- Other company and product names mentioned herein may be registered trademarks, trademarks or trade names of their respective owners.
- Actual product color may be different from the colors shown in this printed material.
- Internet sales are strictly prohibited and unauthorized. Any HVAC systems purchased on the Internet, from an online retailer or any similar e-tailing website, OR where the original factory serial numbers of the display have been removed, defaced, or replaced in any way WILL NOT BE COVERED BY WARRANTY.



Distributed by :

Part #7-26-FG6010 Rev. 7/2023
AIRSTAGE is a worldwide trademark of FUJITSU GENERAL LIMITED.
Actual product color may be different from the colors shown here. Specifications and design are subject to change without notice.

FUJITSU

FUJITSU GENERAL AMERICA, INC.
fujitsugeneral.com

A subsidiary of
FUJITSU GENERAL LIMITED